



1200V SiC MOSFET Power Module

V_{DS}	1200 V
$R_{DS,on}$	77 mΩ
$I_D (T_C=25°C)$	30 A
$T_{J,max}$	175°C

Features

- High speed switching SiC MOSFETs
- Simple to drive
- Kelvin reference for stable operation

Benefits

- Low switching losses
- Low junction to case thermal resistance
- Very rugged and easy mount
- Direct mounting to heatsink (isolated package)

Applications

- Photovoltaic Inverter
- Battery charger
- Server power supplies
- Energy storage system

Package

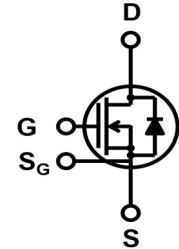

- (1) S_G (Driver Source)
- (2) G (Gate)
- (3) D (Drain)
- (4) S (Source)

Part #	Package	Marking
GCMX080B120S1-E1	SOT-227	GCMX080B120S1-E1



Absolute Maximum Ratings

Characteristics	Symbol	Conditions	Values	Unit
Drain-Source Voltage	V_{rated}	$V_{GS}=0V, I_D=1\mu A$	1200	V
Continuous Drain Current	I_{DS}	$T_C=25°C, V_{GS}=20V$	30	A
		$T_C=100°C, V_{GS}=20V$	22	
Body Diode Drain Current	I_{SD}	$T_C=25°C, V_{GS}=-5V$	34	
Pulsed Drain Current	$I_{DS,pulse}$	$T_C=25°C, V_{GS}=20V$	80	
Gate Source Voltage	V_{GSmax}		-10/25	V
	V_{GSop}	Recommended operational	-5/20	
Power Dissipation	P_{tot}	$T_C=25°C$	142	W
Operating & Storage Temperature	$T_J, T_{storage}$	Continuous	-55...175	°C

1200V SiC MOSFET Power Module

GCMX080B120S1-E1

Static Electrical Characteristics, at $T_J=25^\circ\text{C}$, unless otherwise specified

Characteristics	Symbol	Conditions	Values			Unit
			min.	typ.	max.	
Drain-Source Breakdown Voltage	BV_{DSS}	$V_{GS}=0V, I_D=1mA$	1200	-	-	V
Zero Gate Voltage Drain Current	I_{DSS}	$V_{DS}=1200V, V_{GS}=0V$	-	0.1	1	μA
		$V_{DS}=1200V, V_{GS}=0V, T_J=175^\circ\text{C}$	-	1	-	
Gate-Source Leakage Current	I_{GSS+}	$V_{GS}=20V, V_{DS}=0V$	-	-	100	nA
	I_{GSS-}	$V_{GS}=-5V, V_{DS}=0V$	-	-	-100	
Gate Threshold Voltage	$V_{GS(th)}$	$V_{GS}=V_{DS}, I_D=10mA$	2	2.8	4	V
		$V_{GS}=V_{DS}, I_D=10mA, T_J=175^\circ\text{C}$	-	2.0	-	
Drain-Source On-Resistance	$R_{DS(on)}$	$V_{GS}=20V, I_D=20A$	-	77	100	m Ω
		$V_{GS}=20V, I_D=10A$	-	71	90	
		$V_{GS}=20V, I_D=20A, T_J=125^\circ\text{C}$	-	106	-	
		$V_{GS}=20V, I_D=20A, T_J=175^\circ\text{C}$	-	134	-	
Transconductance	g_{fs}	$V_{DS}=20V, I_D=20A$	-	8.0	-	S
Internal Gate Resistance	$R_{G(int)}$	$f=1MHz, V_{AC}=25mV, D-S$ Short	-	3.0	-	Ω

AC Electrical Characteristics, at $T_J=25^\circ\text{C}$, unless otherwise specified

Characteristics	Symbol	Conditions	Values			Unit
			min.	typ.	max.	
Input Capacitance	C_{ISS}	$V_{GS}=0V$	-	1336	-	pF
Output Capacitance	C_{OSS}	$V_{DS}=1000V$	-	73	-	
Reverse Transfer Capacitance	C_{RSS}	$f=200kHz$	-	8	-	
Coss Stored Energy	E_{OSS}^*	$V_{AC}=25mV$	-	41	-	μJ
Turn-On Switching Energy	E_{ON}		-	192	-	μJ
Turn-Off Switching Energy	E_{OFF}	$V_{DD}=800V, I_{DS}=20A,$ $R_{G(ext)}=2.5\Omega,$	-	40	-	
Turn-On Delay Time	$t_{D(on)}$	$V_{GS}=-5/+20V, L=975\mu H,$	-	9	-	ns
Rise Time	t_R	FWD= GCMX080A120S1-E1	-	4	-	
Turn-Off Delay Time	$t_{D(off)}$		-	15	-	
Fall Time	t_F		-	11	-	
Total Gate Charge	Q_G	$V_{DD}=800V, I_{DS}=20A$	-	58	-	nC
Gate to Source Charge	Q_{GS}	$V_{GS}=-5/20V$	-	18	-	
Gate to Drain Charge	Q_{GD}		-	17	-	

* E_{OSS} is calculated from C_{OSS} curve

Freewheeling Diode Characteristics, at $T_J=25^\circ\text{C}$, unless otherwise specified

Characteristics	Symbol	Conditions	Values			Unit
			min.	typ.	max.	
Diode Forward Voltage	V_{SD}	$V_{GS}=-5V, I_S=10A$	-	3.8	-	V
Reverse Recovery Time	t_{RR}	$I_S=20A, V_R=800V, V_{GS}=-5V$	-	8	-	ns
Reverse Recovery Charge	Q_{RR}	$di/dt=7.9A/ns$	-	159	-	nC
Peak Reverse Recovery Current	I_{RRM}		-	29	-	A

Thermal and Package Characteristics, at $T_j = 25^\circ\text{C}$, unless otherwise specified

Characteristics	Symbol	Conditions	Values			Unit
			min.	typ.	max.	
Thermal resistance, junction-case	R_{thJC}		-	0.83	1.06	$^\circ\text{C}/\text{W}$
Mounting torque	M_d	M4-0.7 screws	1.1	-	1.5	N-m
Terminal connection torque	M_{dt}	M4-0.7 screws	-	1.1	1.3	
Package weight	W_t		-	32	-	g
Isolation voltage	V_{ISOL}	$I_{ISOL} < 1\text{mA}$, 50/60 Hz, 1 min	2500	-	-	V

Typical Performance

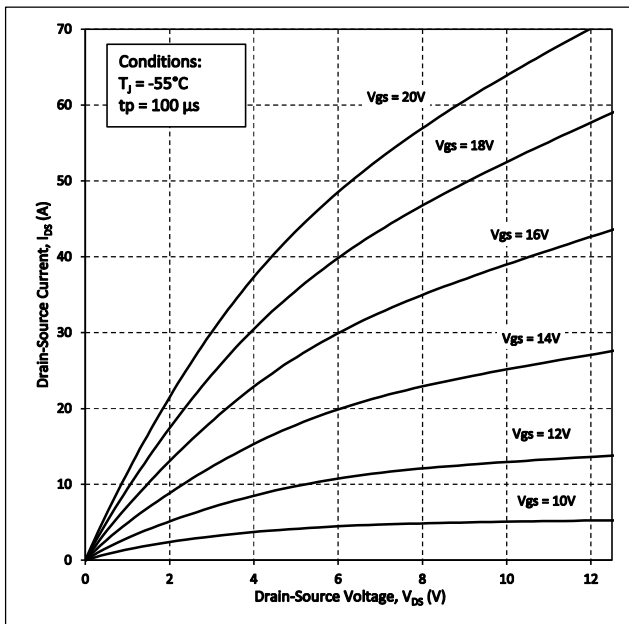

Figure 1. Output Characteristics $T_j = -55^\circ\text{C}$

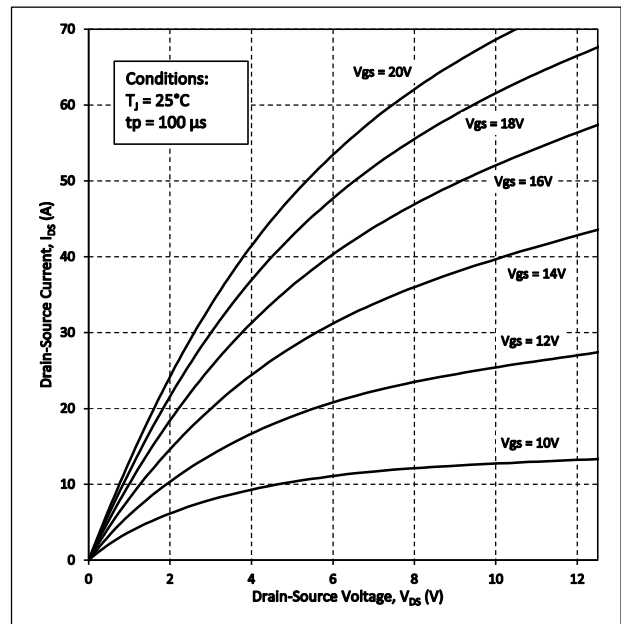

Figure 2. Output Characteristics $T_j = 25^\circ\text{C}$

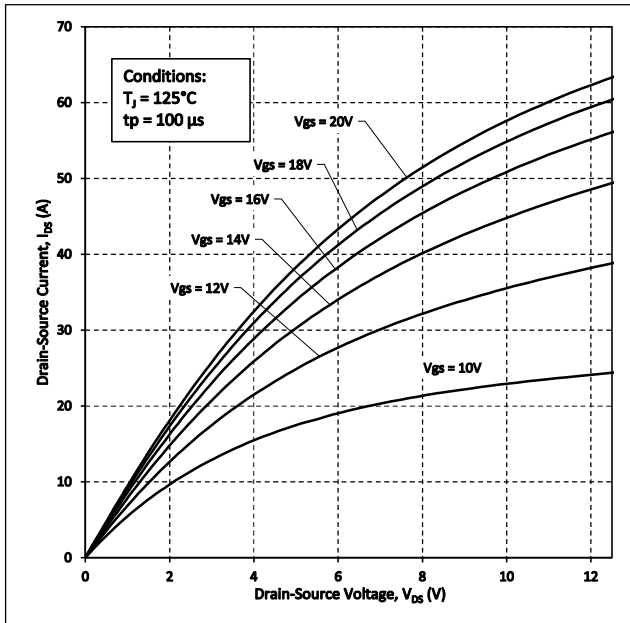

Figure 3. Output Characteristics $T_J = 125^\circ\text{C}$

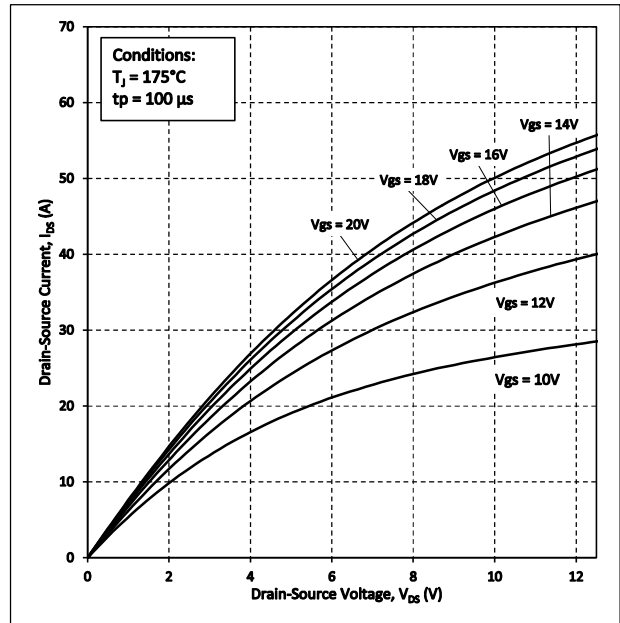

Figure 4. Output Characteristics $T_J = 175^\circ\text{C}$

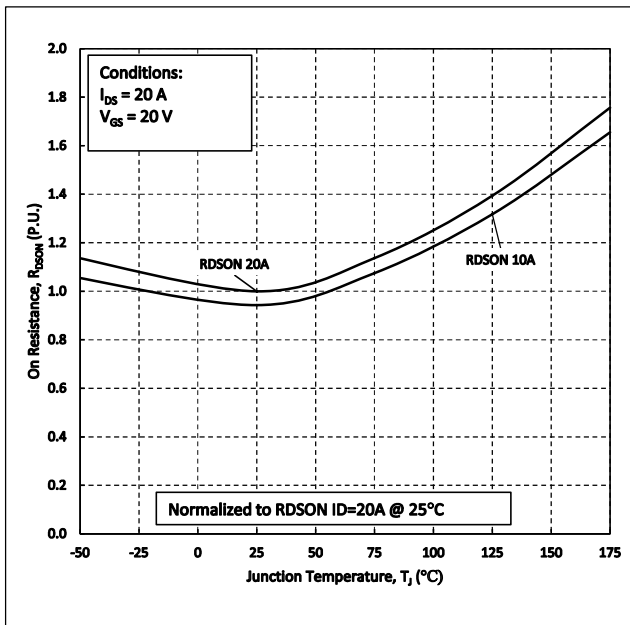

Figure 5. Normalized On-Resistance vs. Temperature

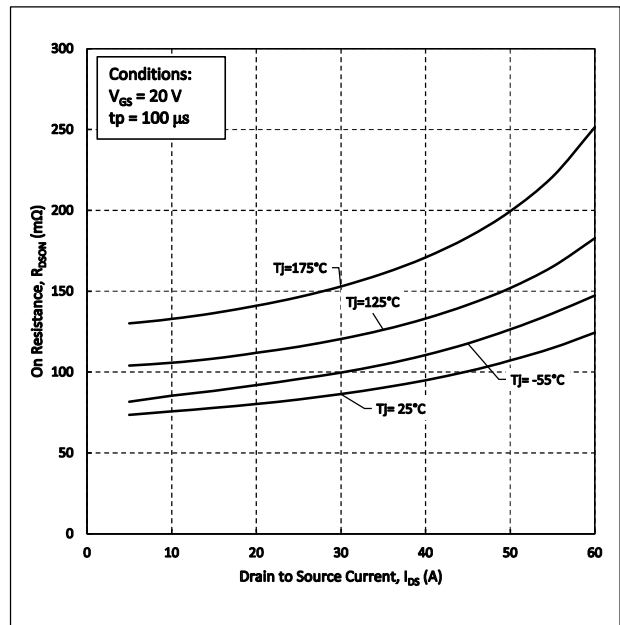

Figure 6. On-Resistance vs. Drain Current For Various Temperature

1200V SiC MOSFET Power Module

GCMX080B120S1-E1

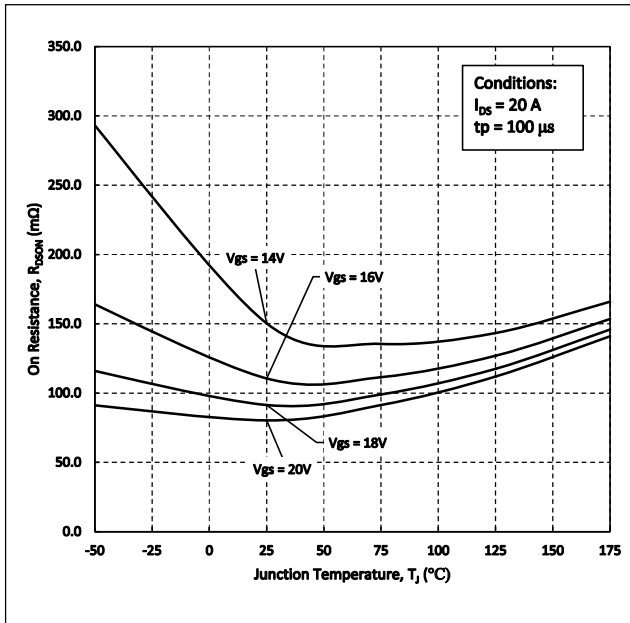

Figure 7. On-Resistance vs. Temperature For Various Gate Voltages

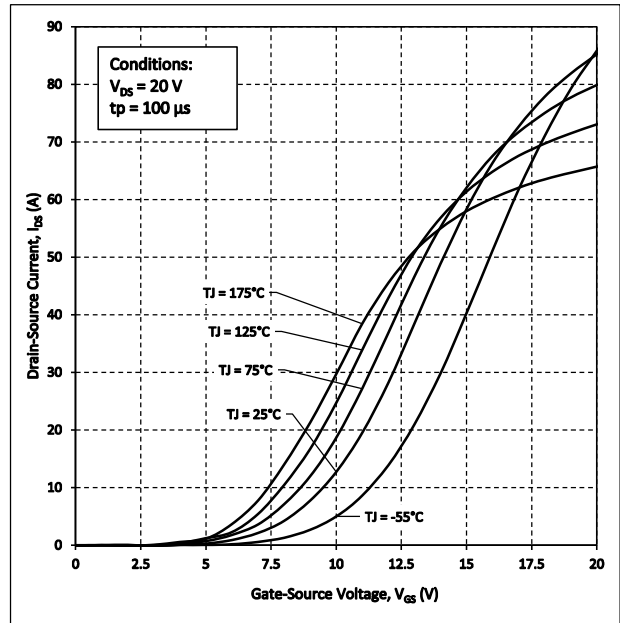

Figure 8. Transfer Characteristic for Various Junction Temperatures

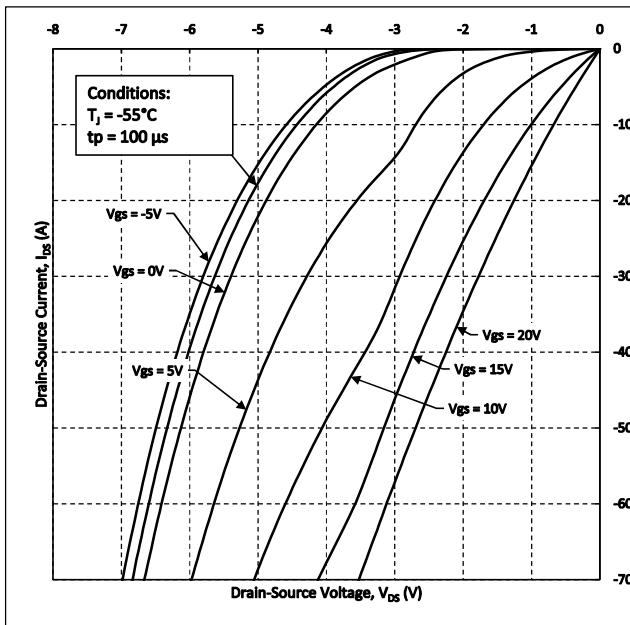

Figure 9. Freewheeling Diode Characteristics at $T_J = -55^\circ\text{C}$

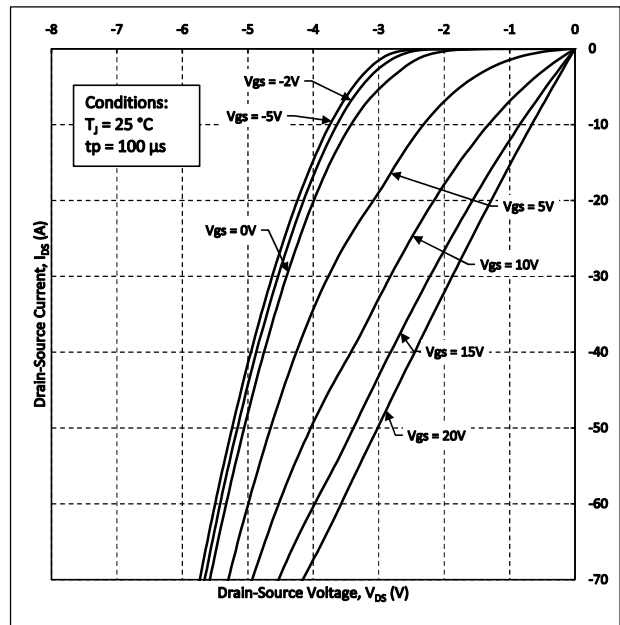

Figure 10. Freewheeling Diode Characteristics at $T_J = 25^\circ\text{C}$

1200V SiC MOSFET Power Module

GCMX080B120S1-E1

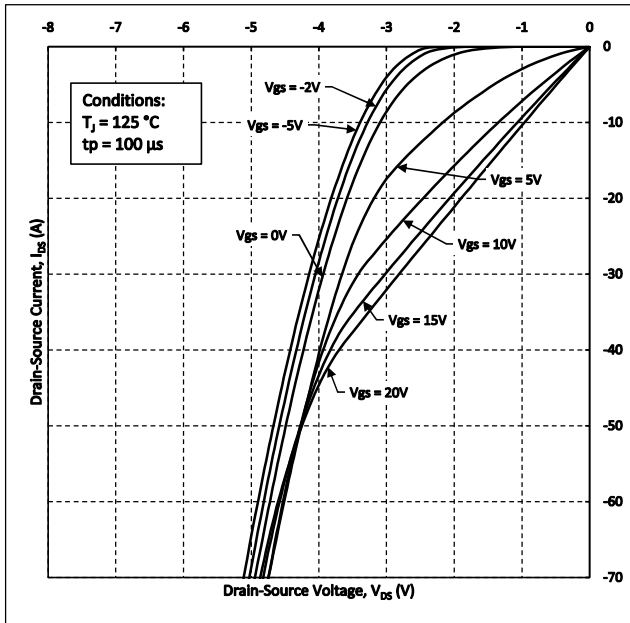

Figure 11. Freewheeling Diode Characteristics at $T_J = 125^\circ\text{C}$

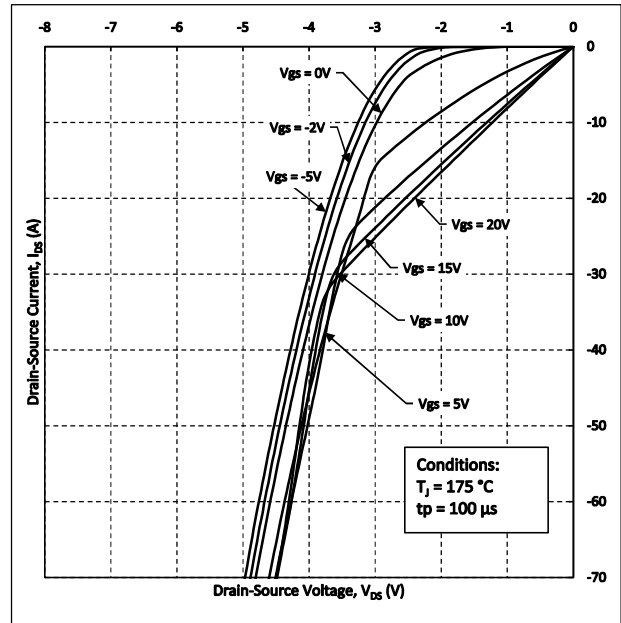

Figure 12. Freewheeling Diode Characteristics at $T_J = 175^\circ\text{C}$

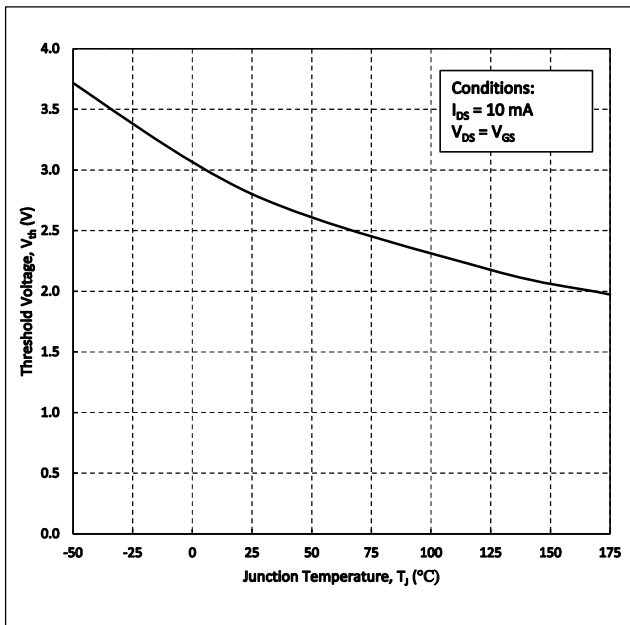

Figure 13. Threshold Voltage vs. Temperature

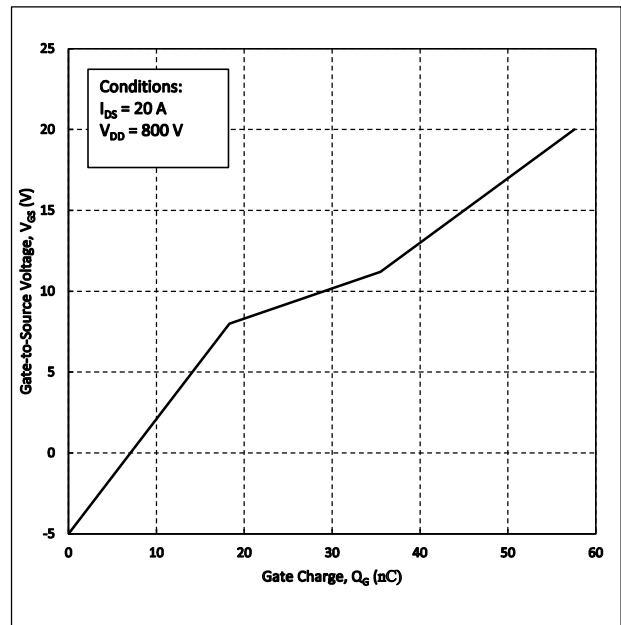

Figure 14. Gate Charge Characteristics

1200V SiC MOSFET Power Module

GCMX080B120S1-E1

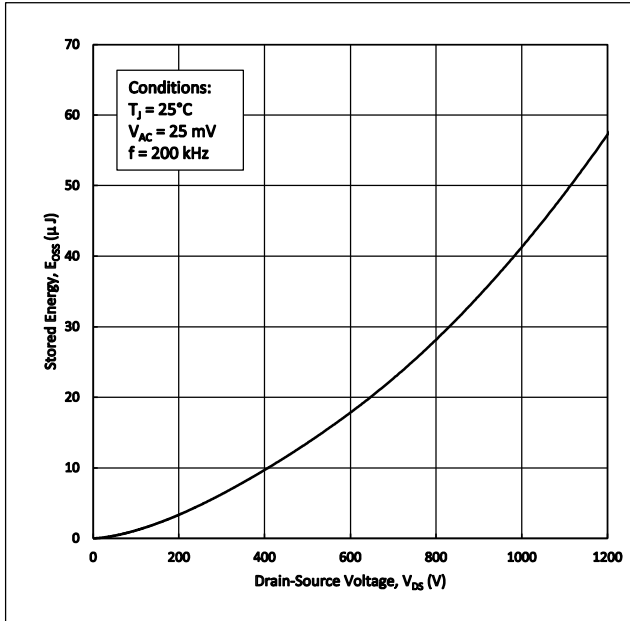

Figure 15. Output Capacitor Stored Energy

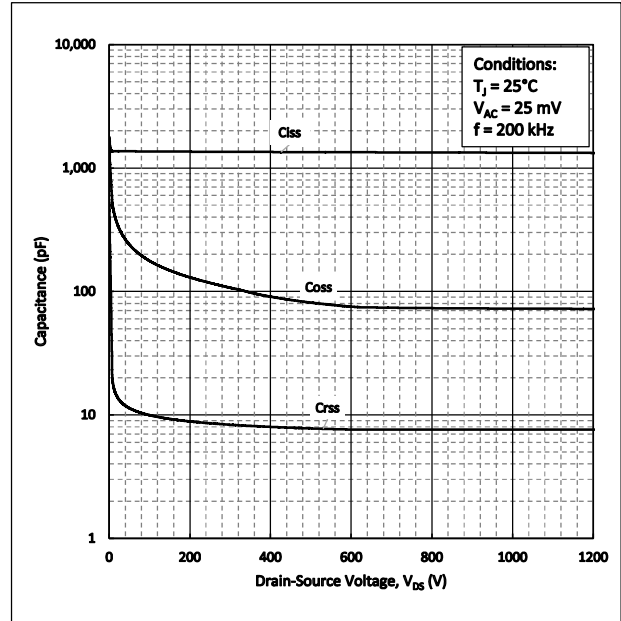

Figure 16. Capacitance vs. Drain-Source Voltage

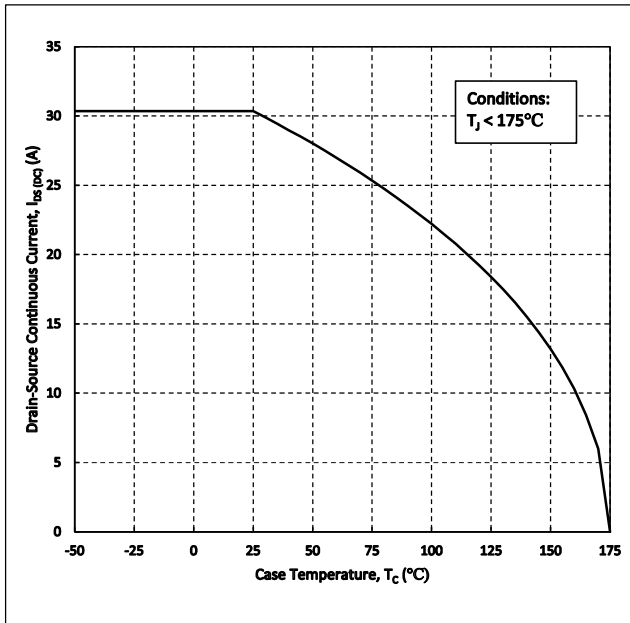

Figure 17. Continuous Drain Current Derating vs. Case Temperature

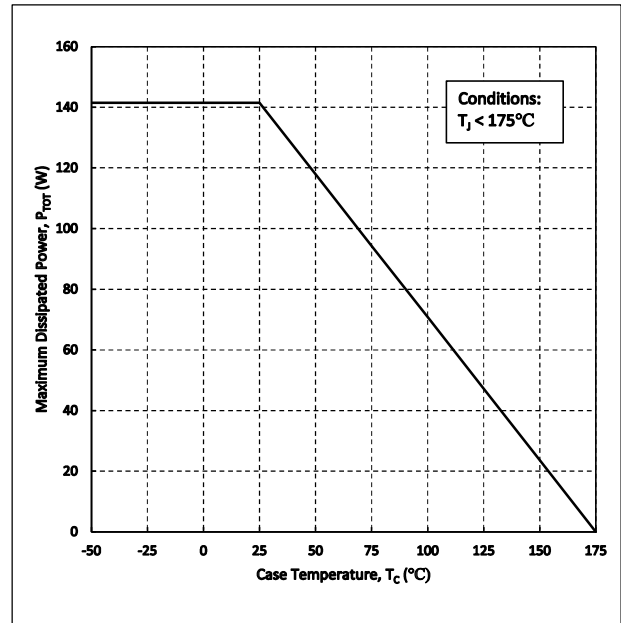

Figure 18. Maximum Power Dissipation Derating vs. Case Temperature

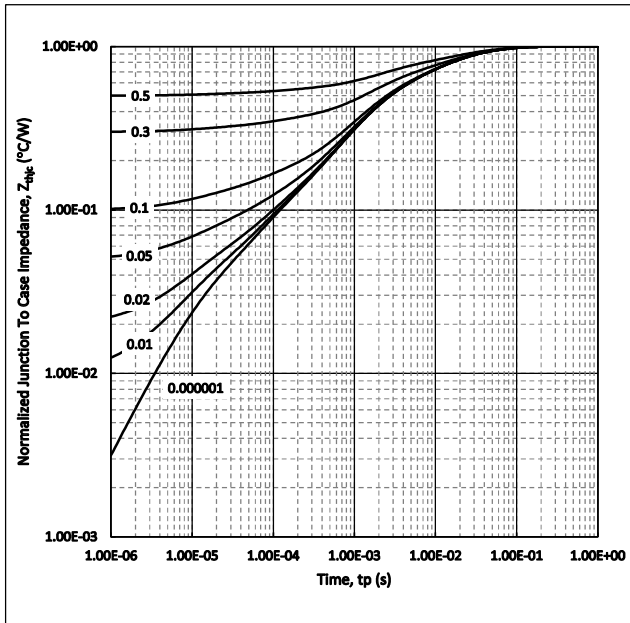

Figure 19. Transient Thermal impedance (Junction to Case)

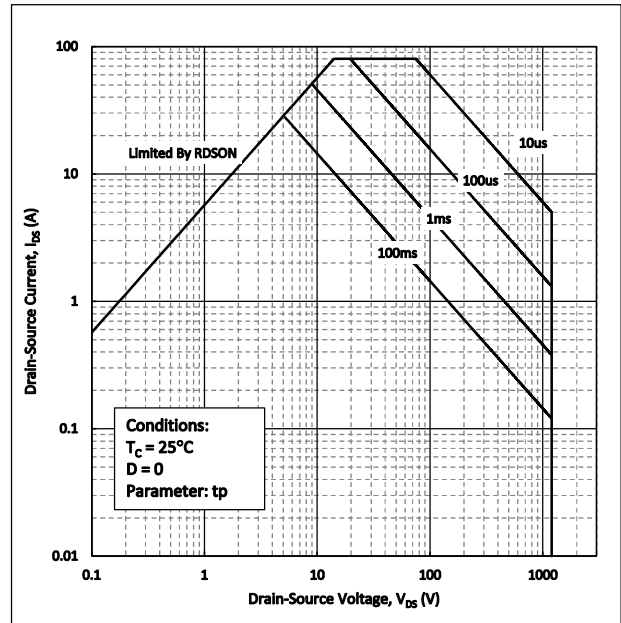

Figure 20. Safe Operating Area

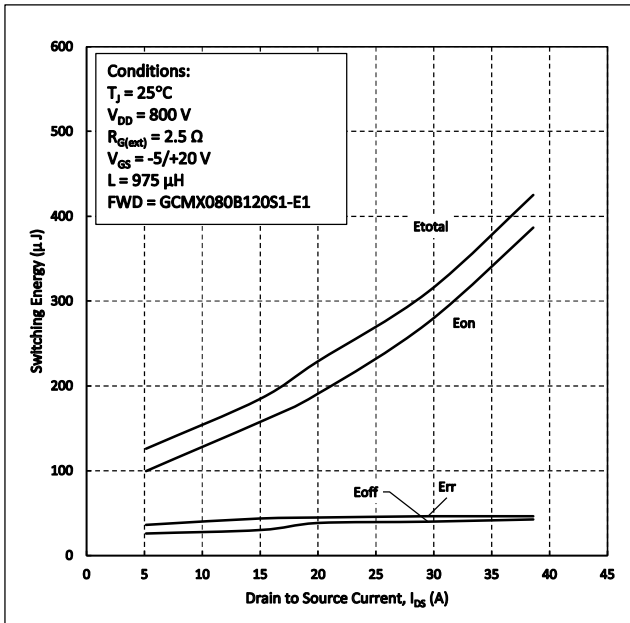

Figure 21. Clamped Inductive Switching Energy vs. Drain Current

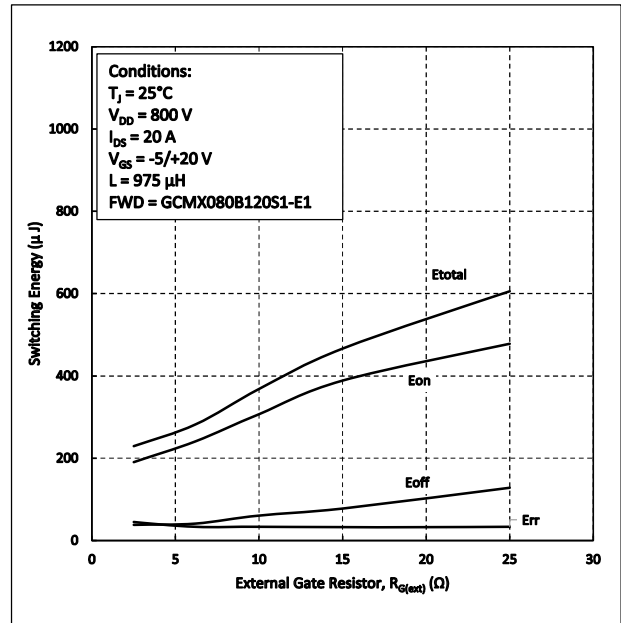

Figure 22. Clamped Inductive Switching Energy vs. $R_{G(ext)}$

1200V SiC MOSFET Power Module

GCMX080B120S1-E1

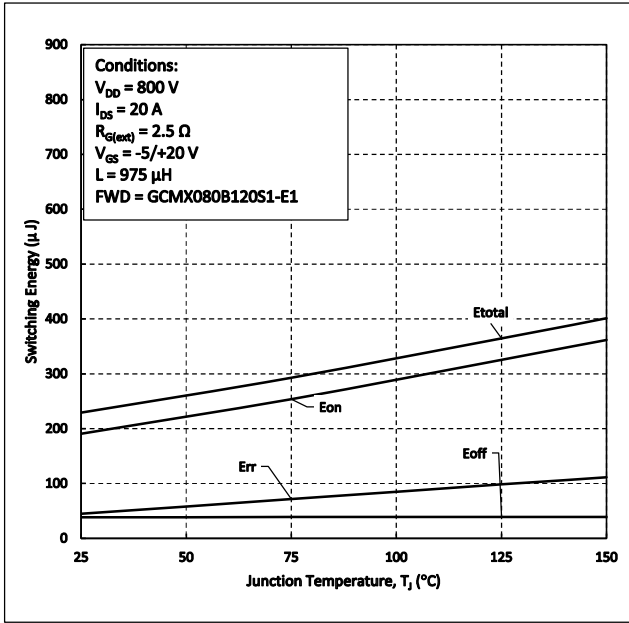

Figure 23. Clamped Inductive Switching Energy vs. Temperature

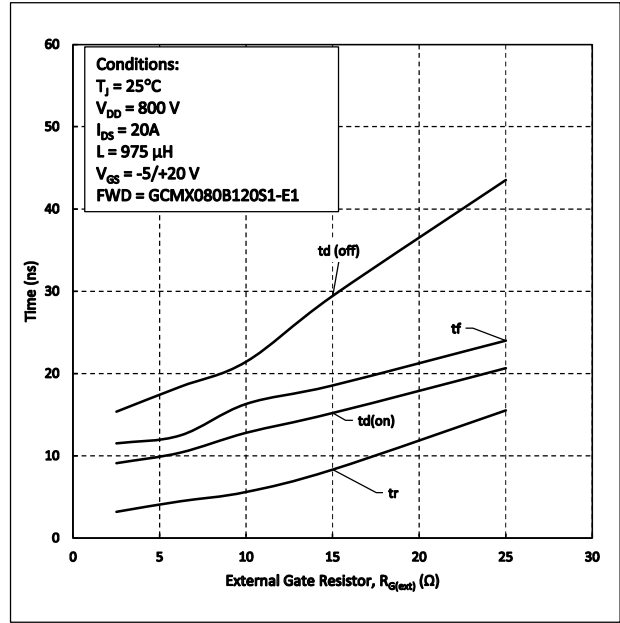

Figure 24. Switching Times vs $R_{G(Ext)}$

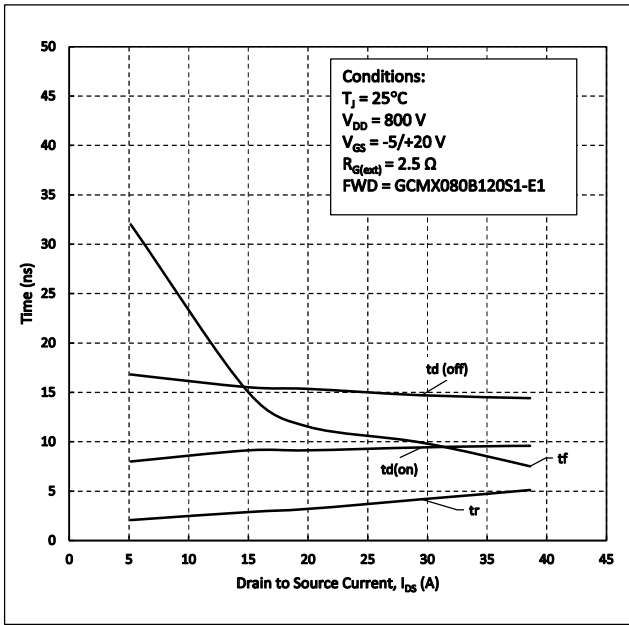

Figure 23. Switching Times vs. Drain Current

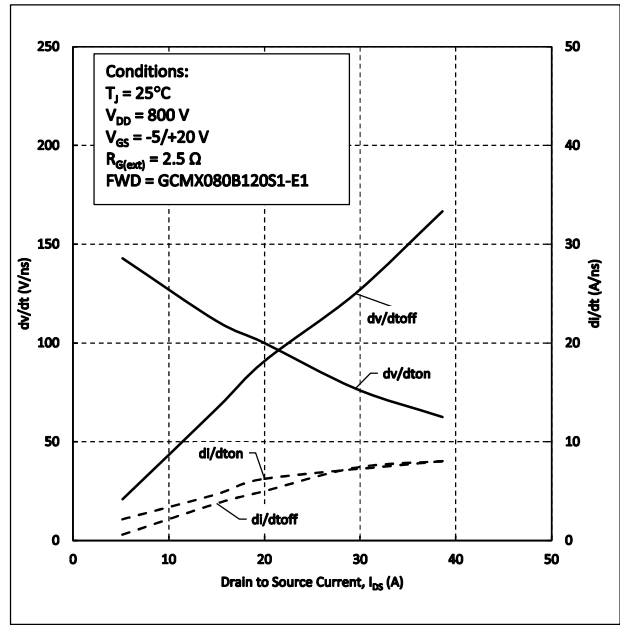

Figure 24. dv/dt and di/dt vs. Drain Current

1200V SiC MOSFET Power Module

GCMX080B120S1-E1

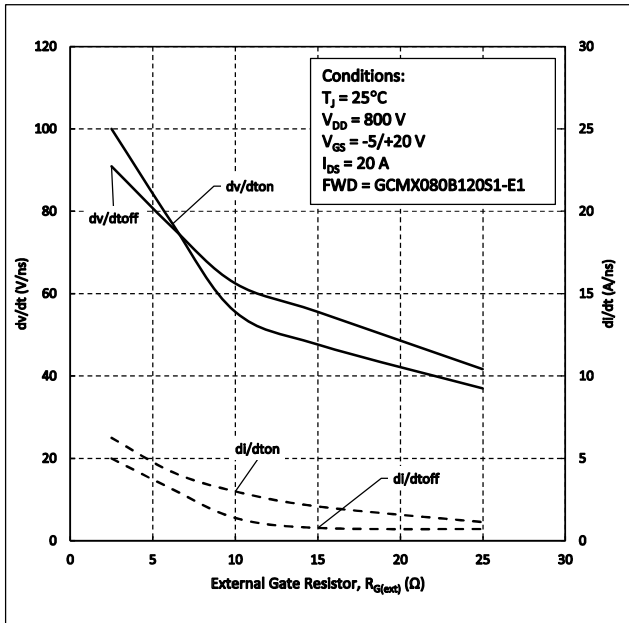

Figure 25. dv/dt and di/dt vs. $R_{G(ext)}$

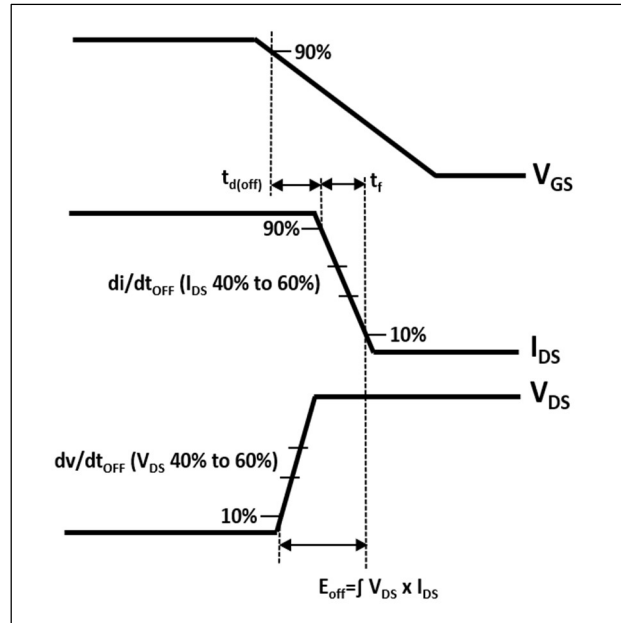

Figure 26. Turn-off Transient Definitions

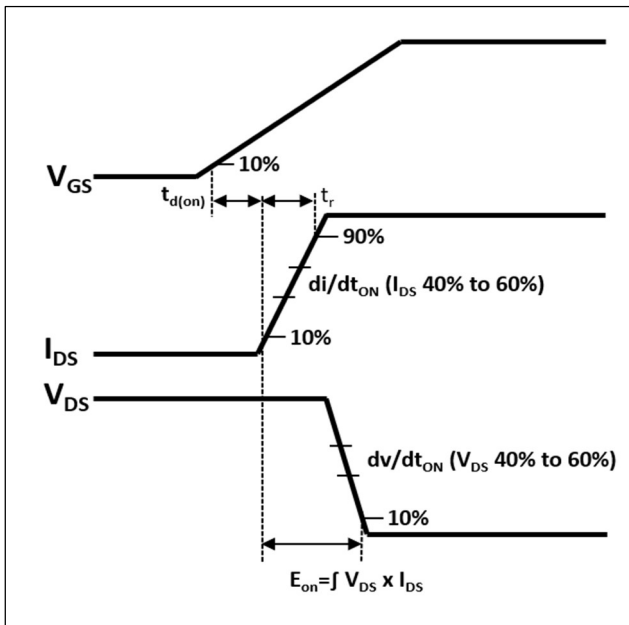

Figure 27. Turn-on Transient Definitions

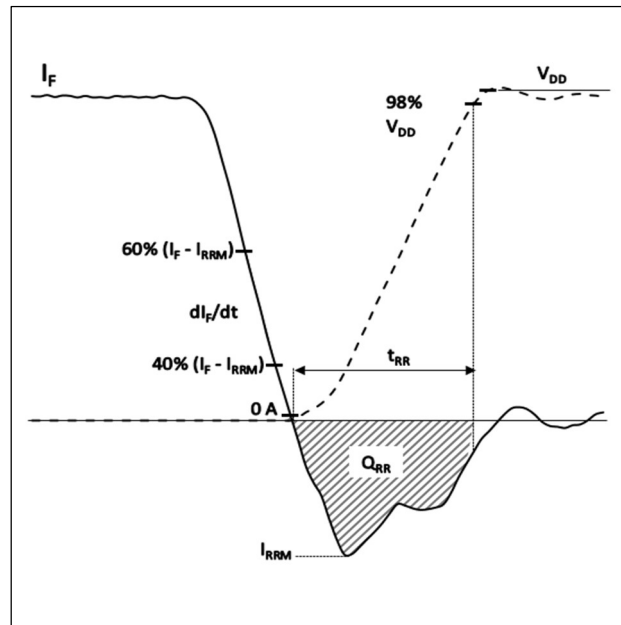
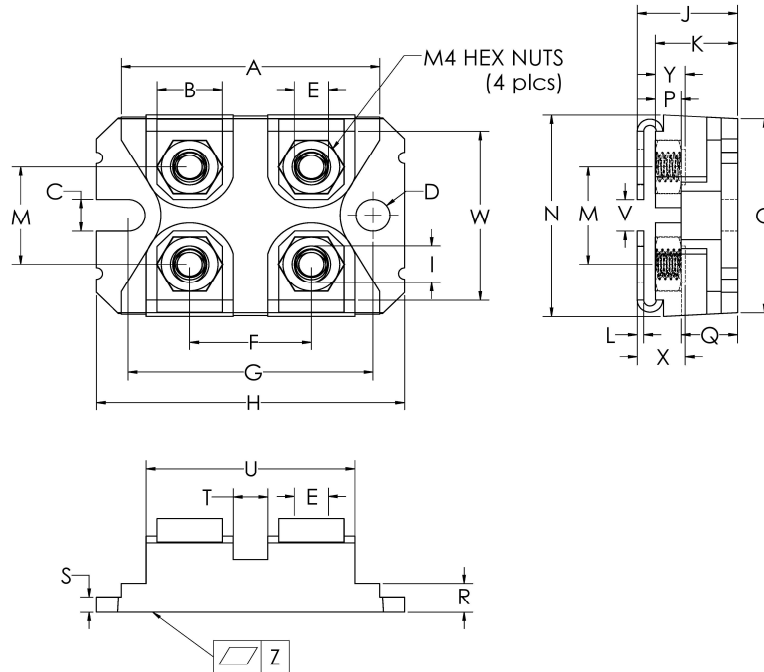

Figure 28. Reverse Recovery Definitions

1200V SiC MOSFET Power Module

GCMX080B120S1-E1

Package Dimensions SOT-227



Sym	Millimeters		Inches	
	Min	Max	Min	Max
A	31.67	31.90	1.247	1.256
B	7.95	8.18	0.313	0.322
C	4.14	4.24	0.163	0.167
D	4.14	4.24	0.163	0.167
E	4.14	4.24	0.163	0.167
F	14.94	15.09	0.588	0.594
G	30.15	30.25	1.187	1.191
H	38.00	38.10	1.496	1.500
I	4.75	4.83	0.187	0.190
J	11.68	12.19	0.460	0.480
K	9.45	9.60	0.372	0.378
L	0.76	0.84	0.030	0.033
M	12.62	12.88	0.497	0.507
N	25.15	25.30	0.990	0.996
O	24.79	25.04	0.976	0.986
P	3.02	3.15	0.119	0.124
Q	6.71	6.96	0.264	0.274
R	4.17	4.42	0.164	0.174
S	2.08	2.13	0.082	0.084
T	3.28	3.63	0.129	0.143
U	26.75	26.90	1.053	1.059
V	3.86	4.24	0.152	0.167
W	20.55	26.90	0.809	0.814
X	5.45	5.85	0.215	0.230
Y	3.15	3.66	0.124	0.144
Z	0.00	0.13	0.000	0.005

Revision History		
Date	Revision	Notes
12/6/2021	0.1	Preliminary release
2/4/2022	1.0	Initial release

Notes

RoHS Compliance

The levels of RoHS restricted materials in this product are below the maximum concentration values (also referred to as the threshold limits) permitted for such substances, or are used in an exempted application, in accordance with EU Directive 2011/65/EC (RoHS2), as implemented March, 2013. RoHS Declarations for this product can be obtained from the Product Documentation sections of www.SemiQ.com.

REACH Compliance

REACH substances of high concern (SVHC) information is available for this product. Since the European Chemicals Agency (ECHA) has published notice of their intent to frequently revise the SVHC listing for the foreseeable future, please contact our office at SemiQ Headquarters in Lake Forest, California to insure you get the most up-to-date REACH SVHC Declaration. REACH banned substance information (REACH Article 67) is also available upon request.

SemiQ Inc., reserves the right to make changes to the product specifications and data in this document without notice. SemiQ products are sold pursuant to SemiQ's terms and conditions of sale in place at the time of order acknowledgement.

This product has not been designed or tested for use in, and is not intended for use in, applications implanted into the human body nor in applications in which failure of the product could lead to death, personal injury or property damage, including but not limited to equipment used in the operation of nuclear facilities, life-support machines, cardiac defibrillators or similar emergency medical equipment, aircraft navigation or communication or control systems, or air traffic control.

SemiQ makes no warranty, representation or guarantee regarding the suitability of its products for any particular purpose, nor does SemiQ assume any liability arising out of the application or use of any product or circuit, and specifically disclaims any and all liability, including without limitation special, consequential or incidental damages. Buyer is responsible for its products and applications using SemiQ products.

To obtain additional technical information or to place an order for this product, please contact us. The information in this datasheet is provided by SemiQ.