

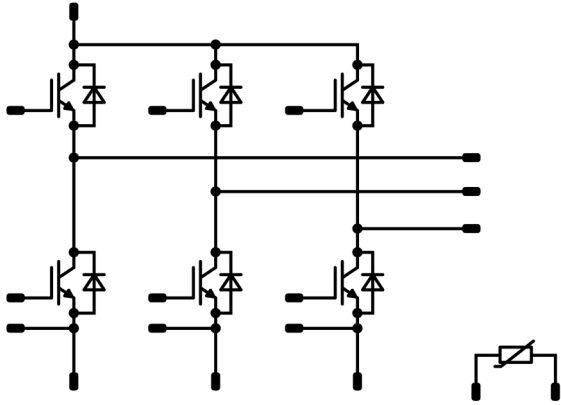

Vincotech

flowPACK E1	1200 V / 35 A
<div style="border: 1px solid black; padding: 5px; margin-bottom: 5px;"> <p style="text-align: center; background-color: #cccccc;">Features</p> <ul style="list-style-type: none"> Trench IGBT4 chip technology Compact design Integrated NTC </div> <div style="border: 1px solid black; padding: 5px; margin-bottom: 5px;"> <p style="text-align: center; background-color: #cccccc;">Target applications</p> <ul style="list-style-type: none"> Industrial Drives UPS </div> <div style="border: 1px solid black; padding: 5px;"> <p style="text-align: center; background-color: #cccccc;">Types</p> <ul style="list-style-type: none"> 10-EZ126PA035SC-L859F48T </div>	<div style="border: 1px solid black; padding: 5px; margin-bottom: 5px;"> <p style="text-align: center; background-color: #cccccc;">flow E1 12 mm housing</p>  </div> <div style="border: 1px solid black; padding: 5px;"> <p style="text-align: center; background-color: #cccccc;">Schematic</p>  </div>

Maximum Ratings

$T_j = 25\text{ °C}$, unless otherwise specified

Parameter	Symbol	Condition	Value	Unit
Inverter Switch				
Collector-emitter voltage	V_{CES}		1200	V
Collector current	I_C	$T_j = T_{jmax}$ $T_s = 80\text{ °C}$	41	A
Repetitive peak collector current	I_{CRM}	t_p limited by T_{jmax}	105	A
Total power dissipation	P_{tot}	$T_j = T_{jmax}$ $T_s = 80\text{ °C}$	110	W
Gate-emitter voltage	V_{GES}		±20	V
Short circuit ratings	t_{SC}	$T_j \leq 150\text{ °C}$ $V_{GE} = 15\text{ V}$ $V_{CC} = 800\text{ V}$	10	µs
Maximum junction temperature	T_{jmax}		175	°C



Vincotech

Maximum Ratings

$T_j = 25\text{ °C}$, unless otherwise specified

Parameter	Symbol	Condition	Value	Unit
Inverter Diode				
Peak repetitive reverse voltage	V_{RRM}		1200	V
Continuous (direct) forward current	I_F	$T_j = T_{jmax}$ $T_s = 80\text{ °C}$	45	A
Repetitive peak forward current	I_{FRM}		70	A
Total power dissipation	P_{tot}	$T_j = T_{jmax}$ $T_s = 80\text{ °C}$	84	W
Maximum junction temperature	T_{jmax}		175	°C

Module Properties

General Properties

Stray inductance	L_P		25	nH
------------------	-------	--	----	----

Thermal Properties

Storage temperature	T_{stg}		-40...+125	°C
Operation temperature under switching condition	T_{jop}		-40...($T_{jmax} - 25$)	°C

Isolation Properties

Isolation voltage	V_{isol}	DC Test Voltage* $t_p = 2\text{ s}$	6000	V
		AC Voltage $t_p = 1\text{ min}$	2500	V
Creepage distance			min. 12,7	mm
Clearance			8,62	mm
Comparative Tracking Index	CTI		≥ 600	

*100 % tested in production



Characteristic Values

Parameter	Symbol	Conditions					Value			Unit
		V_{GS} [V]	V_{GE} [V]	V_{DS} [V]	I_D [A]	T_j [°C]	Min	Typ	Max	

Inverter Switch

Static

Parameter	Symbol	Conditions	V_{GS} [V]	V_{GE} [V]	V_{DS} [V]	I_D [A]	T_j [°C]	Min	Typ	Max	Unit
Gate-emitter threshold voltage	$V_{GE(th)}$	$V_{GE} = V_{CE}$				0,0012	25	5,3	5,8	6,3	V
Collector-emitter saturation voltage	V_{CEsat}		15			35	25 150	1,58	1,87 2,30	2,07	V
Collector-emitter cut-off current	I_{CES}		0	1200			25			5	μA
Gate-emitter leakage current	I_{GES}		20	0			25			120	nA
Internal gate resistance	r_g								none		Ω
Input capacitance	C_{ies}	$f = 1 \text{ Mhz}$	0	25			25		2000		pF
Reverse transfer capacitance	C_{res}								70		
Gate charge	Q_g		-15/15				25		270		nC

Thermal

Thermal resistance junction to sink	$R_{th(j-s)}$	$\lambda_{paste} = 3,4 \text{ W/mK}$ (PSX)							0,87		K/W
-------------------------------------	---------------	---	--	--	--	--	--	--	------	--	-----

Dynamic

Parameter	Symbol	Conditions	V_{GS} [V]	V_{GE} [V]	V_{DS} [V]	I_D [A]	T_j [°C]	Min	Typ	Max	Unit
Turn-on delay time	$t_{d(on)}$	$R_{gon} = 16 \Omega$ $R_{goff} = 16 \Omega$	±15	600	35		25		85		ns
Rise time	t_r							150	89		
Turn-off delay time	$t_{d(off)}$							25	22		
Fall time	t_f							150	26		
Turn-on energy (per pulse)*	E_{on}							25	199		
Turn-off energy (per pulse)*	E_{off}							150	259		
		25	73								
		150	115								
		25	2,48								mWs
		150	3,71								
		25	1,84								
		150	2,91								

* $L_S = 14 \text{ nH}$



Vincotech

Characteristic Values

Parameter	Symbol	Conditions					Value			Unit
		V_{GE} [V]	V_{CE} [V]	I_C [A]	T_j [°C]	Min	Typ	Max		

Inverter Diode

Static

Parameter	Symbol	V_{GS} [V]	V_{DS} [V]	I_D [A]	I_F [A]	T_j [°C]	Min	Typ	Max	Unit
Forward voltage	V_F			35		25 125 150		1,76 1,73 1,70	2,05	V
Reverse leakage current	I_R		1200			25			7,7	μA

Thermal

Parameter	Symbol	Conditions	Value	Unit
Thermal resistance junction to sink	$R_{th(j-s)}$	$\lambda_{paste} = 3,4$ W/mK (PSX)	1,14	K/W

Dynamic

Parameter	Symbol	dI/dt	I_D	I_C	T_j [°C]	Min	Typ	Max	Unit
Peak recovery current	I_{RRM}				25 150		30 34		A
Reverse recovery time	t_{rr}				25 150		298 493		ns
Recovered charge	Q_r	$dI/dt = 1463$ A/μs $dI/dt = 1493$ A/μs	±15	600	35	25 150	3,79 7,00		μC
Reverse recovered energy	E_{rec}				25 150		1,48 2,81		mWs
Peak rate of fall of recovery current	$(di_{rf}/dt)_{max}$				25 150		122 105		A/μs

Thermistor

Parameter	Symbol	Conditions	Value	Unit
Rated resistance	R		25	kΩ
Deviation of R_{100}	$\Delta_{R/R}$	$R_{100} = 493$ Ω	100	-5
Power dissipation	P		25	245
Power dissipation constant			25	1,4
B-value	$B_{(25/50)}$	Tol. ±2 %	25	3375
B-value	$B_{(25/100)}$	Tol. ±2 %	25	3437
Vincotech NTC Reference				K



Inverter Switch Characteristics

figure 1. IGBT

Typical output characteristics

$I_C = f(V_{CE})$

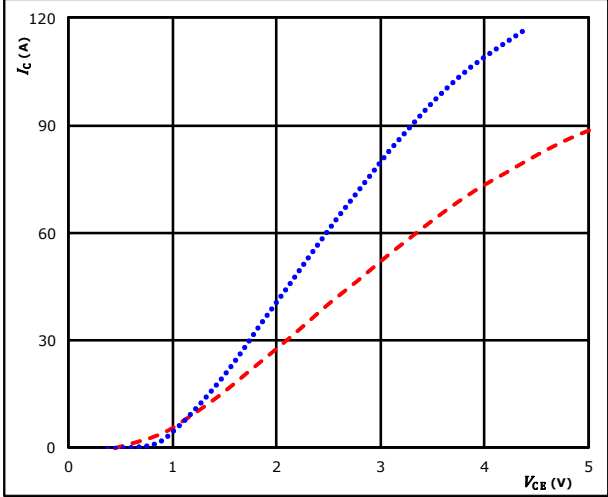

$t_p = 250 \mu s$
 $V_{GE} = 15 V$
 $T_j: 25 \text{ } ^\circ C$ (dotted blue)
 $150 \text{ } ^\circ C$ (dashed red)

figure 2. IGBT

Typical output characteristics

$I_C = f(V_{CE})$

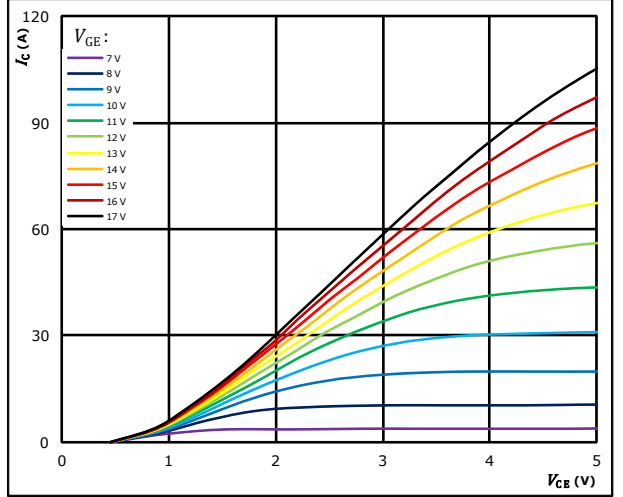

$t_p = 250 \mu s$
 $T_j = 150 \text{ } ^\circ C$
 V_{GE} from 7 V to 17 V in steps of 1 V

figure 3. IGBT

Typical transfer characteristics

$I_C = f(V_{GE})$

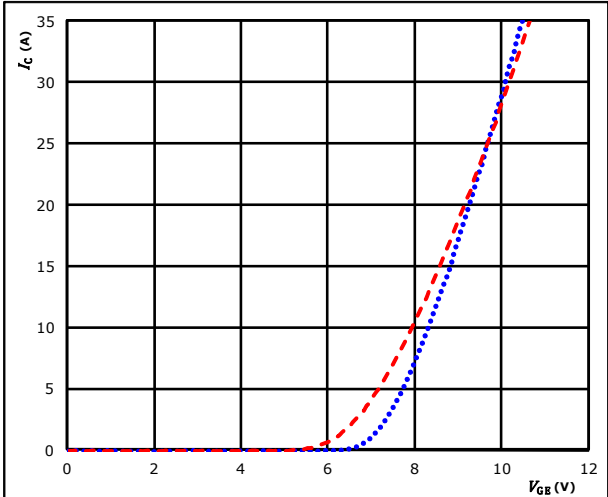

$t_p = 100 \mu s$
 $V_{CE} = 10 V$
 $T_j: 25 \text{ } ^\circ C$ (dotted blue)
 $150 \text{ } ^\circ C$ (dashed red)

figure 4. IGBT

Transient thermal impedance as function of pulse duration

$Z_{th(j-s)} = f(t_p)$

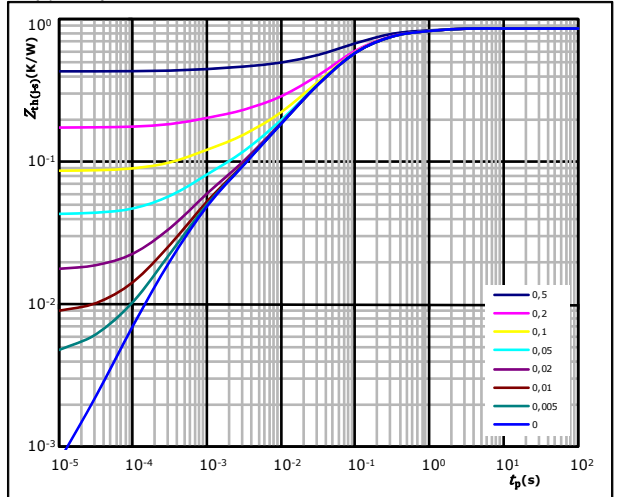

$D = t_p / T$
 $R_{th(j-s)} = 0,87 \text{ K/W}$

IGBT thermal model values

R (K/W)	τ (s)
1,19E-01	7,84E-01
3,72E-01	1,14E-01
2,65E-01	3,81E-02
6,99E-02	6,87E-03
3,98E-02	7,25E-04



Vincotech

Inverter Switch Characteristics

figure 5. IGBT

Safe operating area

$$I_C = f(V_{CE})$$

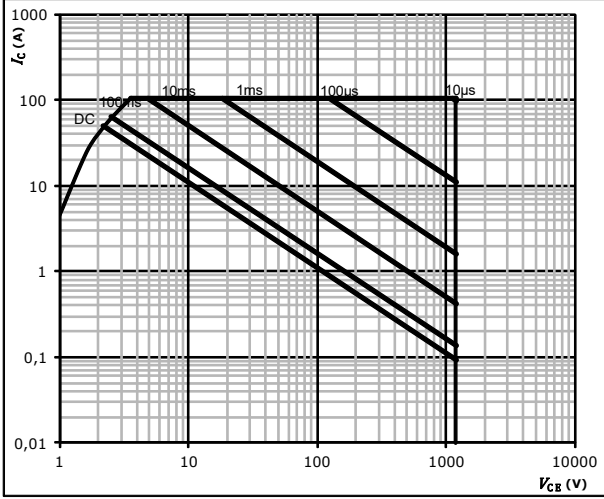

- $D =$ single pulse
- $T_s =$ 80 °C
- $V_{GE} =$ ±15 V
- $T_j = T_{jmax}$



Inverter Diode Characteristics

figure 1. FWD

Typical forward characteristics

$$I_F = f(V_F)$$

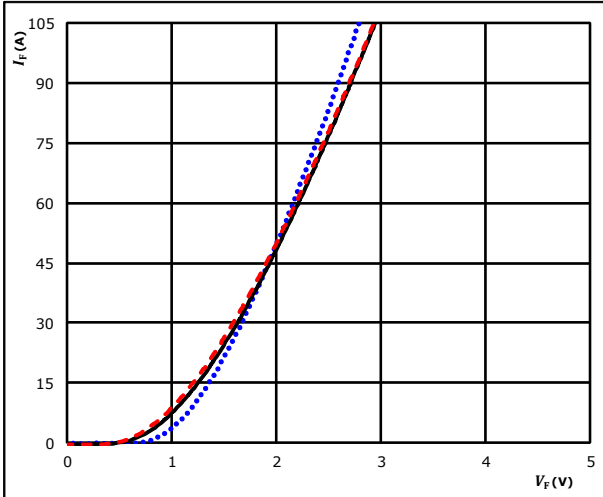

$t_p = 250 \mu s$
 T_j : 25 °C
 125 °C ———
 150 °C - - - -

figure 2. FWD

Transient thermal impedance as a function of pulse width

$$Z_{th(j-s)} = f(t_p)$$

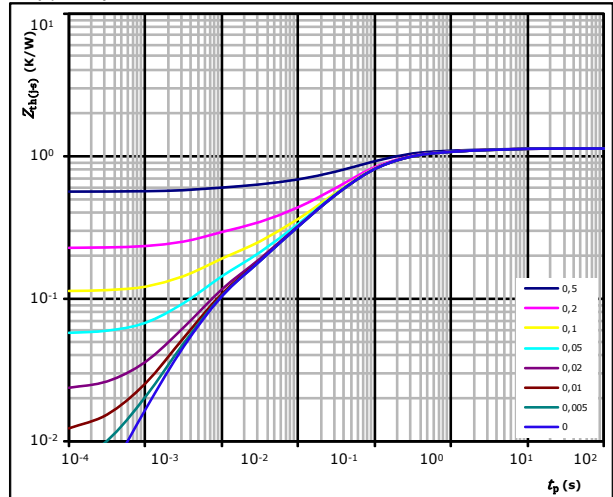

$D = t_p / T$
 $R_{th(j-s)} = 1,14 \text{ K/W}$
 FWD thermal model values

R (K/W)	τ (s)
5,93E-02	3,57E+00
1,54E-01	4,09E-01
5,28E-01	7,51E-02
2,09E-01	2,04E-02
9,97E-02	4,95E-03
8,47E-02	6,04E-04

Thermistor Characteristics

figure 1. Thermistor

Typical NTC characteristic
as a function of temperature

$$R = f(T)$$

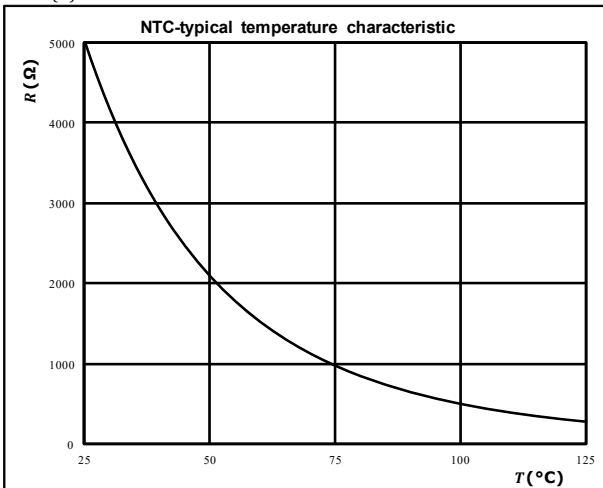



Inverter Switching Characteristics

figure 1. IGBT

Typical switching energy losses as a function of collector current

$$E = f(I_C)$$

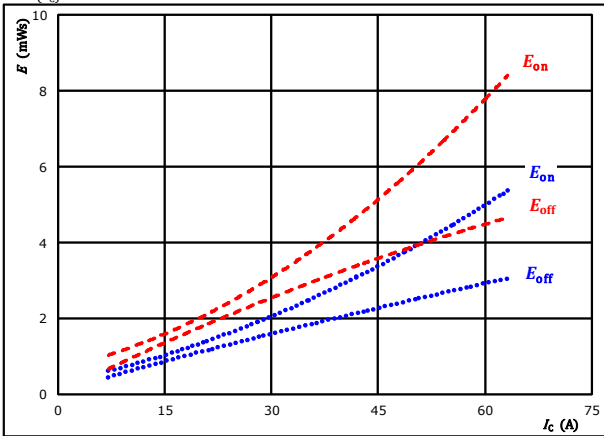

With an inductive load at

$V_{CE} = 600$ V
 $V_{GE} = \pm 15$ V
 $R_{gon} = 16$ Ω
 $R_{goff} = 16$ Ω

T_j : 25 °C (blue dotted line)
150 °C (red dashed line)

figure 2. IGBT

Typical switching energy losses as a function of gate resistor

$$E = f(R_g)$$

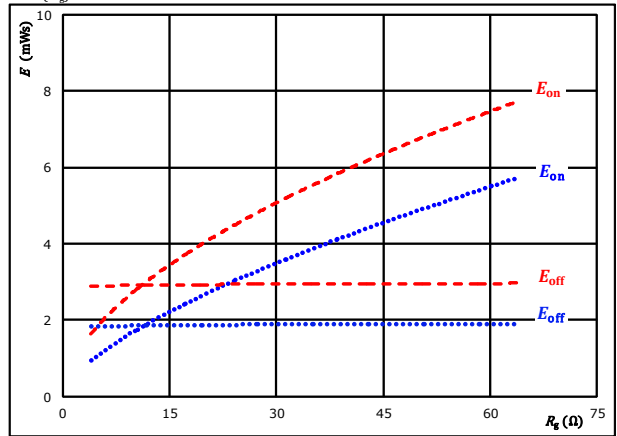

With an inductive load at

$V_{CE} = 600$ V
 $V_{GE} = \pm 15$ V
 $I_C = 35$ A

T_j : 25 °C (blue dotted line)
150 °C (red dashed line)

figure 3. FWD

Typical reverse recovered energy loss as a function of collector current

$$E_{rec} = f(I_C)$$

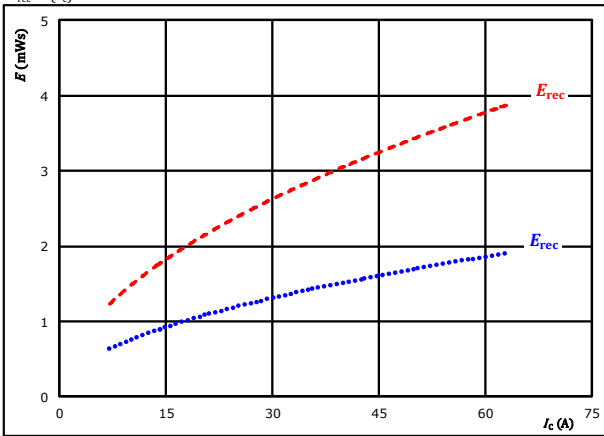

With an inductive load at

$V_{CE} = 600$ V
 $V_{GE} = \pm 15$ V
 $R_{gon} = 16$ Ω

T_j : 25 °C (blue dotted line)
150 °C (red dashed line)

figure 4. FWD

Typical reverse recovered energy loss as a function of gate resistor

$$E_{rec} = f(R_g)$$

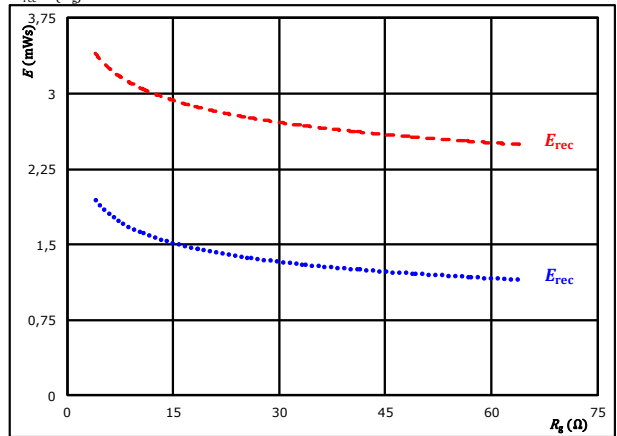

With an inductive load at

$V_{CE} = 600$ V
 $V_{GE} = \pm 15$ V
 $I_C = 35$ A

T_j : 25 °C (blue dotted line)
150 °C (red dashed line)



Inverter Switching Characteristics

figure 5. IGBT

Typical switching times as a function of collector current

$$t = f(I_C)$$

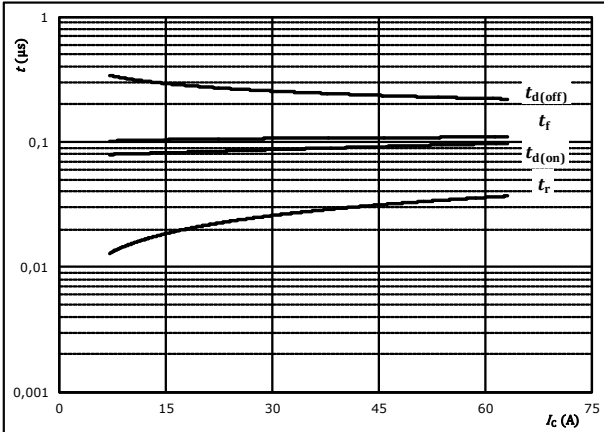

With an inductive load at

$T_j =$	150	°C
$V_{CE} =$	600	V
$V_{GE} =$	±15	V
$R_{g(on)} =$	16	Ω
$R_{g(off)} =$	16	Ω

figure 6. IGBT

Typical switching times as a function of gate resistor

$$t = f(R_g)$$

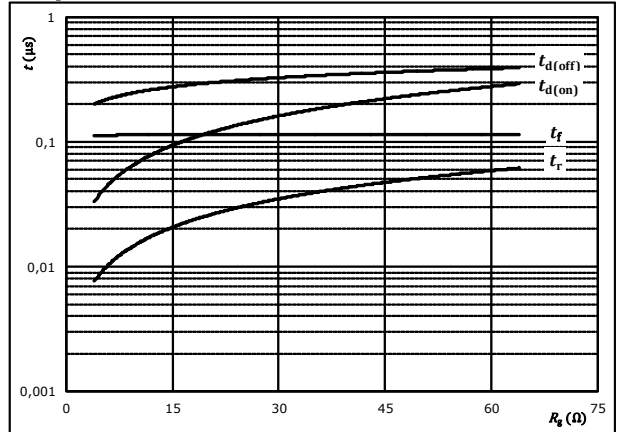

With an inductive load at

$T_j =$	150	°C
$V_{CE} =$	600	V
$V_{GE} =$	±15	V
$I_C =$	35	A

figure 7. FWD

Typical reverse recovery time as a function of collector current

$$t_{rr} = f(I_C)$$

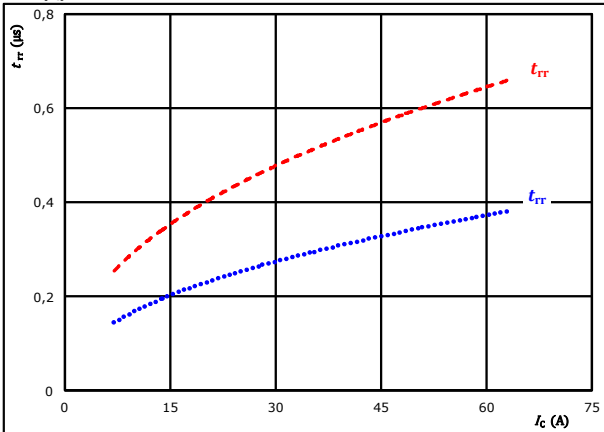

At	$V_{CE} =$	600	V	$T_j:$	25 °C
	$V_{GE} =$	±15	V		150 °C	-----
	$R_{g(on)} =$	16	Ω			

figure 8. FWD

Typical reverse recovery time as a function of IGBT turn on gate resistor

$$t_{rr} = f(R_{g(on)})$$

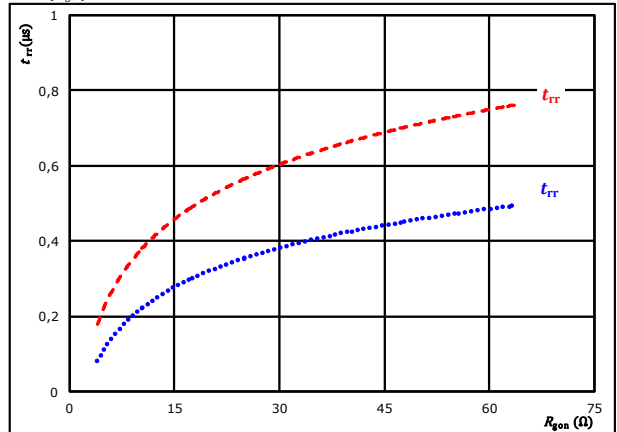

At	$V_{CE} =$	600	V	$T_j:$	25 °C
	$V_{GE} =$	±15	V		150 °C	-----
	$I_C =$	35	A			



Inverter Switching Characteristics

figure 9. FWD

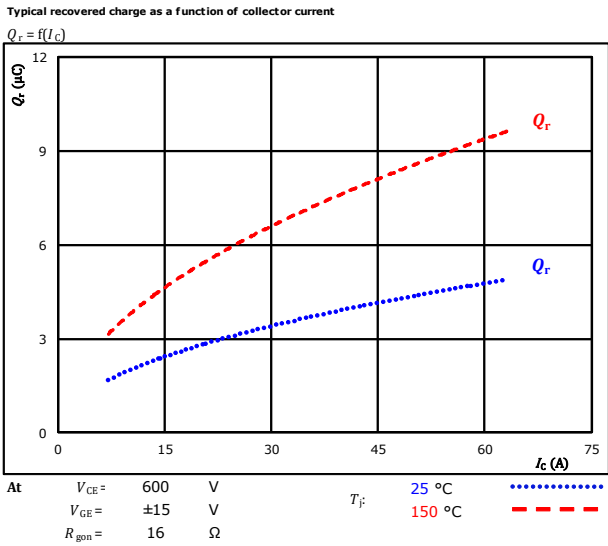

figure 10. FWD

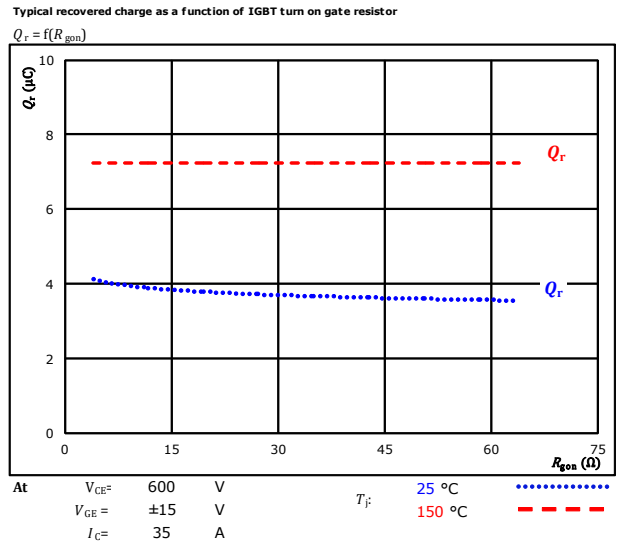

figure 11. FWD

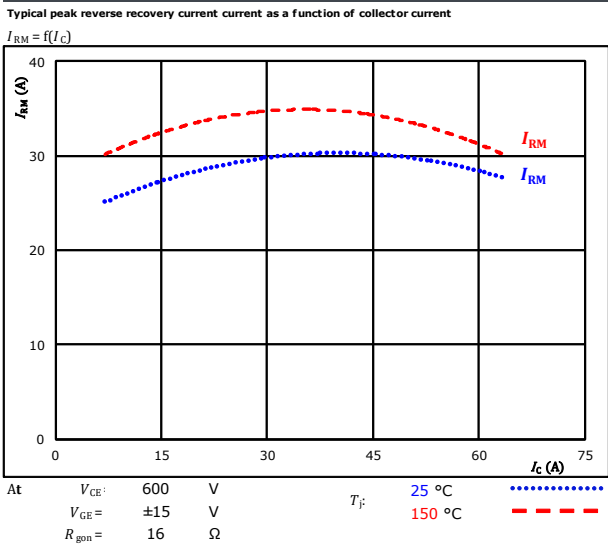
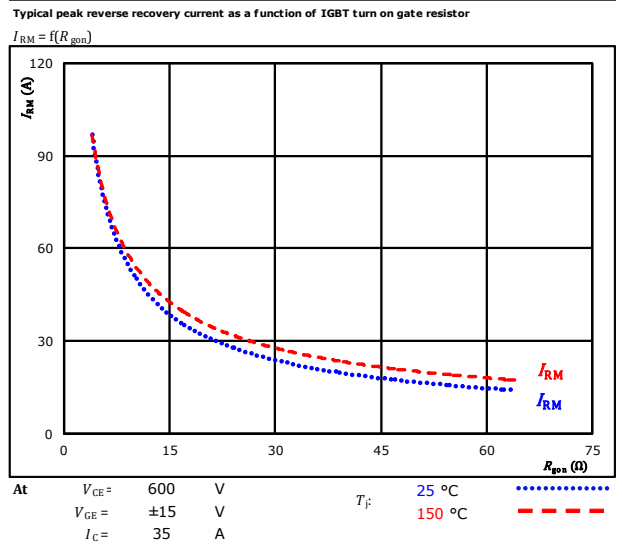

figure 12. FWD





Inverter Switching Characteristics

figure 13. FWD

Typical rate of fall of forward and reverse recovery current as a function of collector current
 $di_f/dt, di_{rr}/dt = f(I_c)$

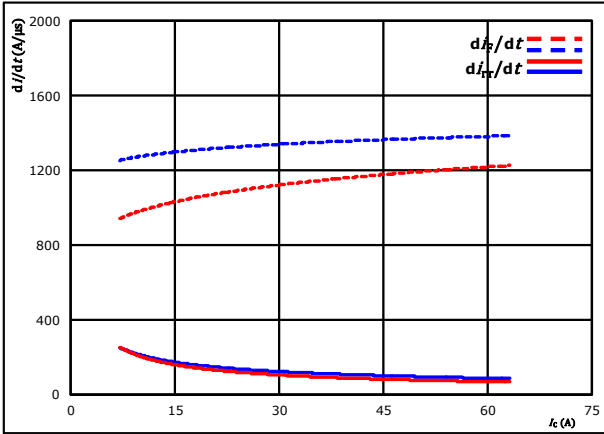

At $V_{CE} = 600$ V $T_j = 25$ °C
 $V_{GE} = \pm 15$ V $T_j = 150$ °C
 $R_{g0n} = 16$ Ω

figure 14. FWD

Typical rate of fall of forward and reverse recovery current as a function of IGBT turn on gate resistor
 $di_f/dt, di_{rr}/dt = f(R_{g0n})$

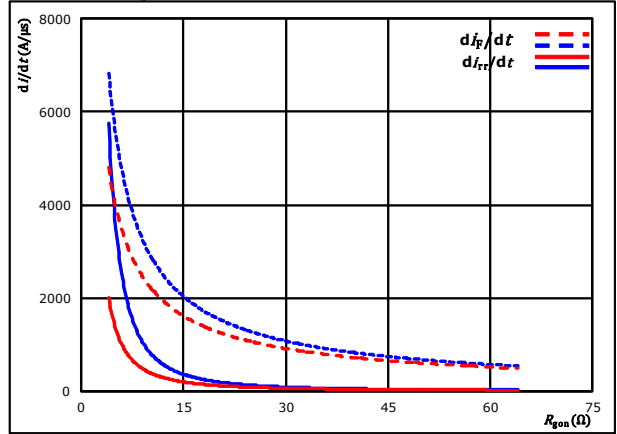

At $V_{CE} = 600$ V $T_j = 25$ °C
 $V_{GE} = \pm 15$ V $T_j = 150$ °C
 $I_c = 35$ A

figure 15. IGBT

Reverse bias safe operating area
 $I_c = f(V_{CB})$

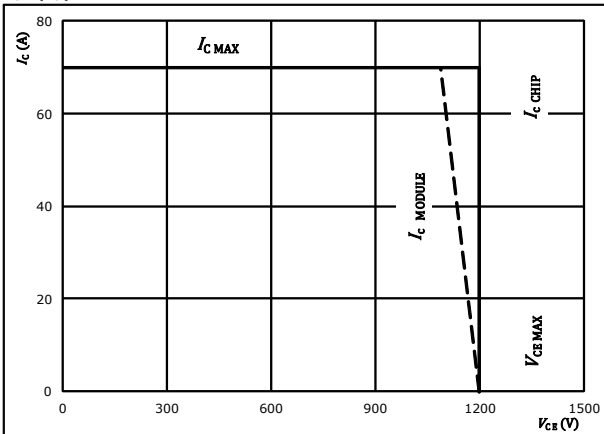

At $T_j = 175$ °C
 $R_{g0n} = 16$ Ω
 $R_{g0ff} = 16$ Ω



Inverter Switching Definitions

General conditions

T_j	=	125 °C
R_{gon}	=	16 Ω
R_{goff}	=	16 Ω

figure 1. IGBT

Turn-off Switching Waveforms & definition of t_{doff} , t_{Eoff} (t_{Eoff} = integrating time for E_{off})

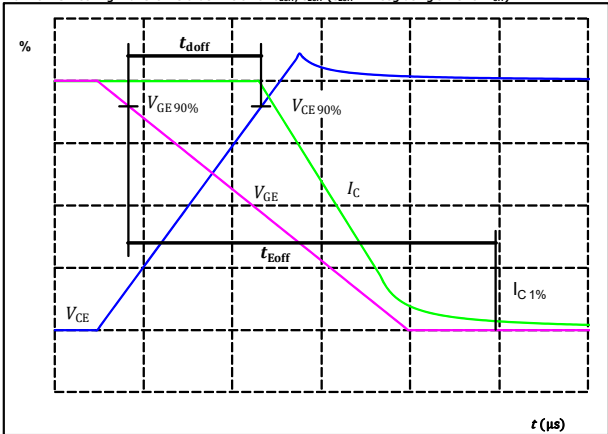

$V_{CE}(0\%) =$	-15	V
$V_{GE}(100\%) =$	15	V
$V_C(100\%) =$	600	V
$I_C(100\%) =$	35	A
$t_{doff} =$	259	ns

figure 2. IGBT

Turn-on Switching Waveforms & definition of t_{don} , t_{Eon} (t_{Eon} = integrating time for E_{on})

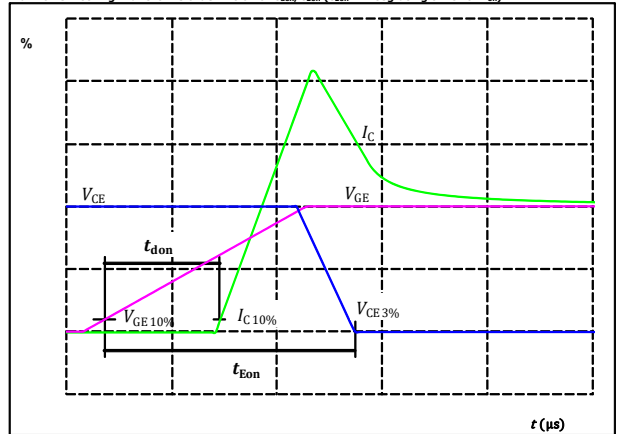

$V_{CE}(0\%) =$	-15	V
$V_{GE}(100\%) =$	15	V
$V_C(100\%) =$	600	V
$I_C(100\%) =$	35	A
$t_{don} =$	89	ns

figure 3. IGBT

Turn-off Switching Waveforms & definition of t_f

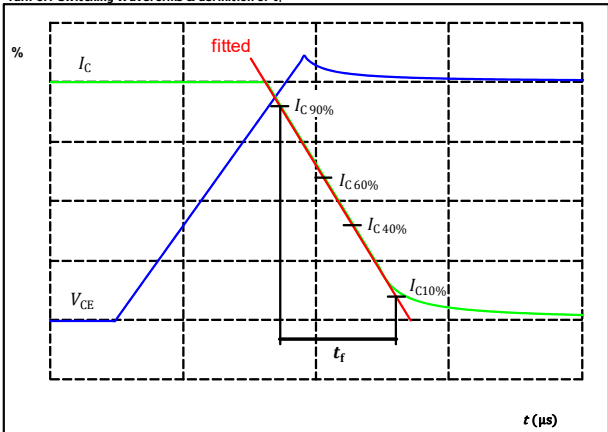

$V_C(100\%) =$	600	V
$I_C(100\%) =$	35	A
$t_f =$	115	ns

figure 4. IGBT

Turn-on Switching Waveforms & definition of t_r

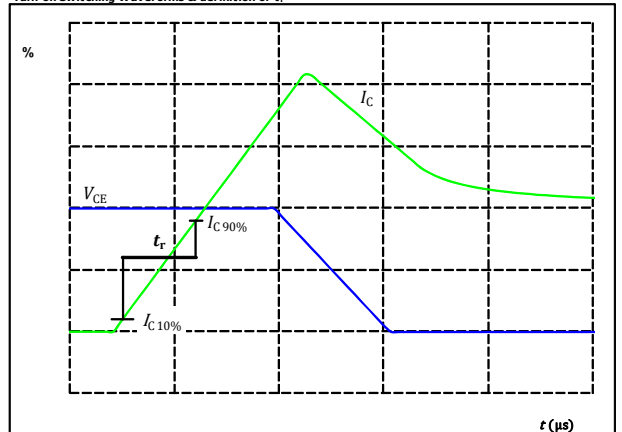

$V_C(100\%) =$	600	V
$I_C(100\%) =$	35	A
$t_r =$	26	ns



Vincotech

Inverter Switching Characteristics

figure 5. FWD

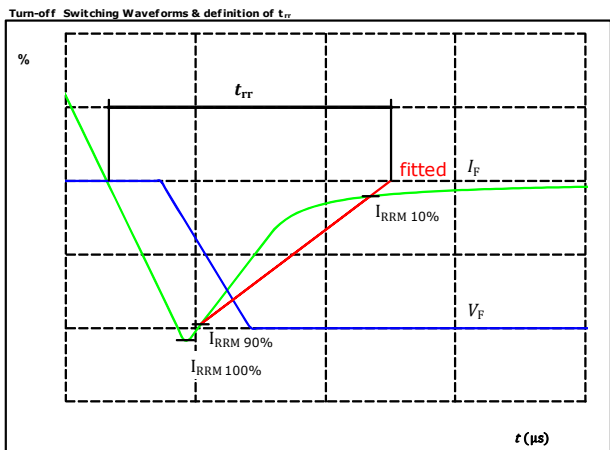

$V_F(100\%) =$	600	V
$I_F(100\%) =$	35	A
$I_{RRM}(100\%) =$	34	A
$t_{rr} =$	493	ns

figure 6. FWD

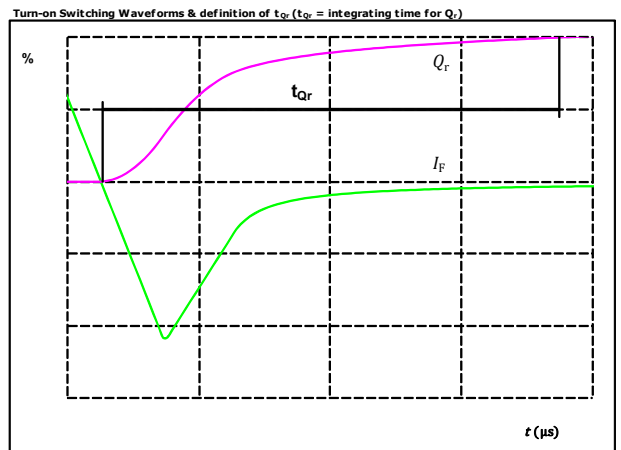

$I_F(100\%) =$	35	A
$Q_r(100\%) =$	7,00	μC



Vincotech

Ordering Code & Marking								
Version			Ordering Code					
without thermal paste 12 mm housing with press-fit pins			10-EZ126PA035SC-L859F48T					
with thermal paste 12 mm housing with press-fit pins			10-EZ126PA035SC-L859F48T-/3/					
NN-NNNNNNNNNNNN TTTTWW WWYY UL VIN LLLL SSSS			Text	Name	Date code	UL & VIN	Lot	Serial
				NN-NNNNNNNNNNNN-TTTTWW	WWYY	UL VIN	LLLL	SSSS
			Datamatrix	Type&Ver	Lot number	Serial	Date code	
			TTTTTWW	LLLL	SSSS	WWYY		

Pin table			
Pin	X	Y	Function
1	12,8	9,6	DC+
2	16	9,6	DC+
3	22,4	9,6	Therm1
4	25,6	9,6	Therm2
5	32	9,6	DC-2
6	32	6,4	S13
7	32	3,2	DC-1
8	32	0	S11
9	28,8	0	G11
10	6,4	0	Ph1
11	3,2	0	Ph1
12	0	0	G12
13	0	6,4	G14
14	0	16	Ph2
15	0	19,2	Ph2
16	0	25,6	G16
17	3,2	25,6	Ph3
18	6,4	25,6	Ph3
19	28,8	25,6	G15
20	32	25,6	S15
21	32	22,4	DC-3
22	32	16	G13

Outline

center of press-fit pinhead
for connection parameter see the handling instruction

13,08 ±0,1
16,4 ±0,5

82,1
16

Tolerance of pinpositions: ±0,4mm at the end of pins
Dimension of coordinate axis is only offset without tolerance



Vincotech

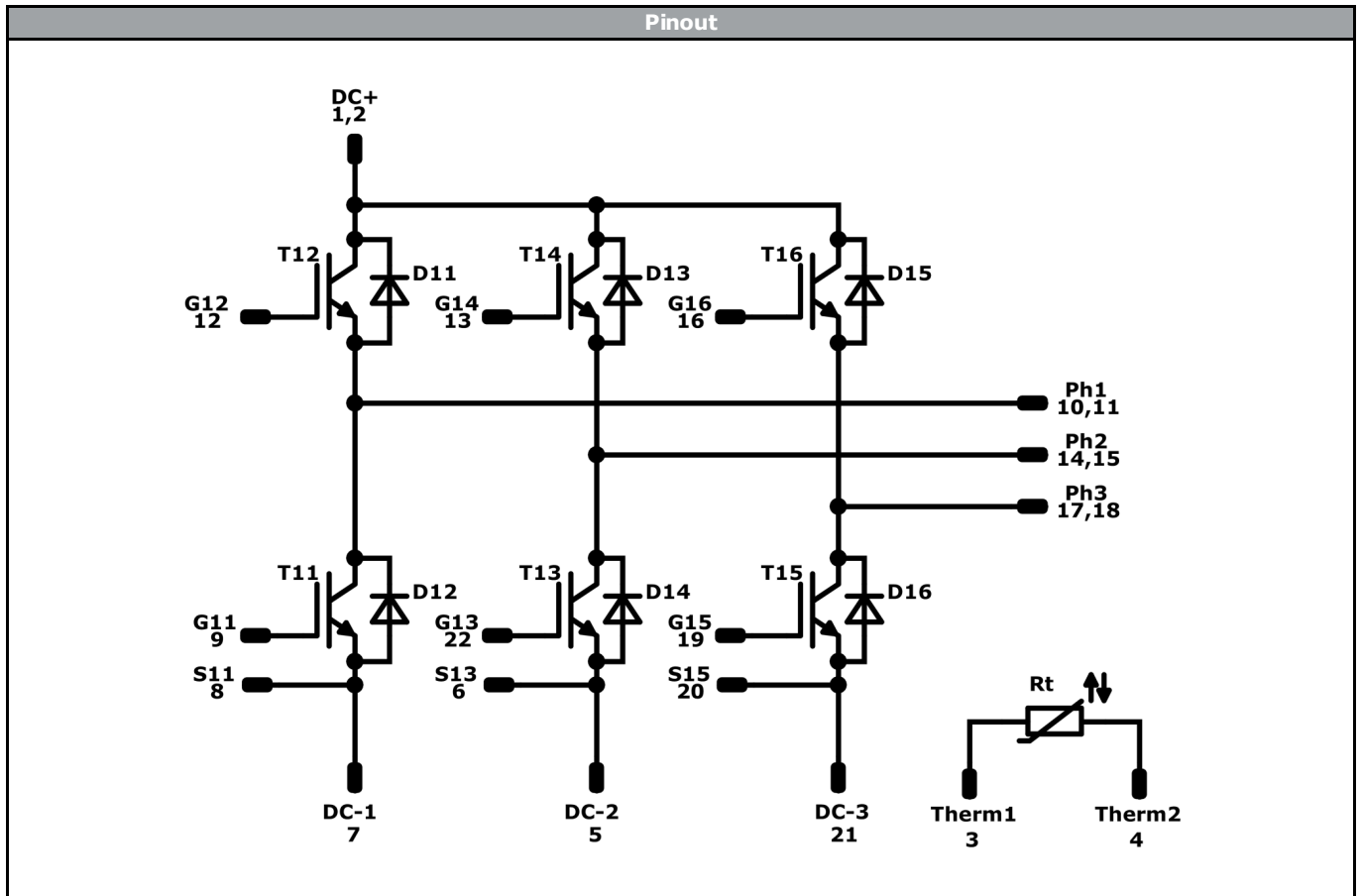

Identification					
ID	Component	Voltage	Current	Function	Comment
T11, T12, T13, T14, T15, T16	IGBT	1200 V	35 A	Inverter Switch	
D11, D12, D13, D14, D15, D16	FWD	1200 V	35 A	Inverter Diode	
Rt	NTC			Thermistor	



Vincotech

Packaging instruction			
Standard packaging quantity (SPQ) 100	>SPQ	Standard	<SPQ Sample

Handling instruction
Handling instructions for <i>flow</i> E1 packages see vincotech.com website.

Package data
Package data for <i>flow</i> E1 packages see vincotech.com website.

UL recognition and file number
This device is certified according to UL 1557 standard, UL file number E192116. For more information see vincotech.com website. 

Document No.:	Date:	Modification:	Pages
10-EZ126PA035SC-L859F48T-D3-14	05 Mar. 2019	Correction of I_c/I_f values	1

DISCLAIMER

The information, specifications, procedures, methods and recommendations herein (together "information") are presented by Vincotech to reader in good faith, are believed to be accurate and reliable, but may well be incomplete and/or not applicable to all conditions or situations that may exist or occur. Vincotech reserves the right to make any changes without further notice to any products to improve reliability, function or design. No representation, guarantee or warranty is made to reader as to the accuracy, reliability or completeness of said information or that the application or use of any of the same will avoid hazards, accidents, losses, damages or injury of any kind to persons or property or that the same will not infringe third parties rights or give desired results. It is reader's sole responsibility to test and determine the suitability of the information and the product for reader's intended use.

LIFE SUPPORT POLICY

Vincotech products are not authorised for use as critical components in life support devices or systems without the express written approval of Vincotech.

As used herein:

1. Life support devices or systems are devices or systems which, (a) are intended for surgical implant into the body, or (b) support or sustain life, or (c) whose failure to perform when properly used in accordance with instructions for use provided in labelling can be reasonably expected to result in significant injury to the user.
2. A critical component is any component of a life support device or system whose failure to perform can be reasonably expected to cause the failure of the life support device or system, or to affect its safety or effectiveness.