



flowPACK 1 H6.5

650 V / 75 A

Features

- Innovative H6.5 topology
- Optimized for bidirectional operation
- Integrated temperature sensor
- Low inductance housing

Target applications

- Energy Storage Systems

Types

- 10-FY07HVA075RG01-L985F48

flow 1 12 mm housing

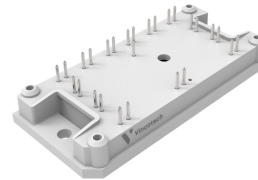

Schematic

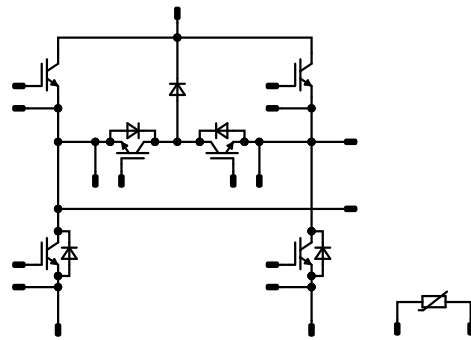



Vincotech

10-FY07HVA075RG01-L985F48
datasheet

Maximum Ratings

$T_j = 25\text{ °C}$, unless otherwise specified

Parameter	Symbol	Conditions	Value	Unit
-----------	--------	------------	-------	------

Buck Switch

Collector-emitter voltage	V_{CES}		650	V
Collector current (DC current)	I_C	$T_j = T_{jmax}$ $T_s = 80\text{ °C}$	58	A
Repetitive peak collector current	I_{CRM}	t_p limited by T_{jmax}	300	A
Total power dissipation	P_{tot}	$T_j = T_{jmax}$ $T_s = 80\text{ °C}$	88	W
Gate-emitter voltage	V_{GES}		± 30	V
Maximum junction temperature	T_{jmax}		175	°C

Buck Diode

Peak repetitive reverse voltage	V_{RRM}		650	V
Forward current (DC current)	I_F	$T_j = T_{jmax}$ $T_s = 80\text{ °C}$	56	A
Repetitive peak forward current	I_{FRM}	t_p limited by T_{jmax}	320	A
Total power dissipation	P_{tot}	$T_j = T_{jmax}$ $T_s = 80\text{ °C}$	80	W
Maximum junction temperature	T_{jmax}		175	°C

Boost Switch

Collector-emitter voltage	V_{CES}		650	V
Collector current (DC current)	I_C	$T_j = T_{jmax}$ $T_s = 80\text{ °C}$	58	A
Repetitive peak collector current	I_{CRM}	t_p limited by T_{jmax}	300	A
Total power dissipation	P_{tot}	$T_j = T_{jmax}$ $T_s = 80\text{ °C}$	88	W
Gate-emitter voltage	V_{GES}		± 30	V
Maximum junction temperature	T_{jmax}		175	°C



Vincotech

10-FY07HVA075RG01-L985F48
datasheet

Maximum Ratings

$T_j = 25\text{ °C}$, unless otherwise specified

Parameter	Symbol	Conditions	Value	Unit
Boost Diode				
Peak repetitive reverse voltage	V_{RRM}		650	V
Forward current (DC current)	I_F	$T_j = T_{jmax}$ $T_s = 80\text{ °C}$	56	A
Repetitive peak forward current	I_{FRM}	t_p limited by T_{jmax}	320	A
Total power dissipation	P_{tot}	$T_j = T_{jmax}$ $T_s = 80\text{ °C}$	80	W
Maximum junction temperature	T_{jmax}		175	°C

Module Properties

Thermal Properties

Storage temperature	T_{stg}		-40...+125	°C
Operation temperature under switching condition	T_{jop}		-40...+($T_{jmax} - 25$)	°C

Isolation Properties

Isolation voltage	V_{isol}	DC Test Voltage* $t_p = 2\text{ s}$	6000	V
Isolation voltage	V_{isol}	AC Voltage $t_p = 1\text{ min}$	2500	V
Creepage distance			>12,7	mm
Clearance			7,85	mm
Comparative Tracking Index	CTI		≥ 200	

*100 % tested in production



Vincotech

Characteristic Values

Parameter	Symbol	Conditions					Values			Unit
		V_{GE} [V] V_{GS} [V]	V_{CE} [V] V_{DS} [V] V_F [V]	I_C [A] I_D [A] I_F [A]	T_j [°C]	Min	Typ	Max		

Buck Switch

Static

Gate-emitter threshold voltage	$V_{GE(th)}$		5	0,0504	25	5	6	7	V
Collector-emitter saturation voltage	$V_{CE(sat)}$	15		75	25 125 150		1,43 1,58 1,61	1,9 ⁽¹⁾	V
Collector-emitter cut-off current	I_{CES}	0	650		25			10	μA
Gate-emitter leakage current	I_{GES}	30	0		25			0,2	μA
Internal gate resistance	r_g						None		Ω

Thermal

Thermal resistance junction to sink ⁽²⁾	$R_{th(j-s)}$	$\lambda_{paste} = 3,4$ W/mK (PSX)					1,08		K/W
--	---------------	---------------------------------------	--	--	--	--	------	--	-----

Dynamic

Turn-on delay time	$t_{d(on)}$	$R_{gon} = 4 \Omega$ $R_{goff} = 4 \Omega$	-5/15	400	75	25		36,43		ns				
						125		35,4						
						150		35,32						
Rise time	t_r									25		10,46		ns
										125		10,48		
										150		10,61		
Turn-off delay time	$t_{d(off)}$									25		85,68		ns
										125		96,53		
										150		99,97		
Fall time	t_f									25		34,99		ns
										125		46,58		
										150		47,28		
Turn-on energy (per pulse)	E_{on}	$Q_{iFWD} = 2,99 \mu C$ $Q_{iFWD} = 4,04 \mu C$ $Q_{iFWD} = 4,64 \mu C$				25		0,308		mWs				
						125		0,437						
						150		0,502						
Turn-off energy (per pulse)	E_{off}					25		1,29		mWs				
						125		1,69						
						150		1,8						



Vincotech

Characteristic Values

Parameter	Symbol	Conditions					Values			Unit
		V_{GE} [V] V_{GS} [V]	V_{CE} [V] V_{DS} [V] V_F [V]	I_C [A] I_D [A] I_F [A]	T_j [°C]	Min	Typ	Max		

Buck Diode

Static

Forward voltage	V_F				80	25 125 150		1,55 1,62 1,61	1,9 ⁽¹⁾	V
Reverse leakage current	I_R	$V_T = 650$ V				25			10	μA

Thermal

Thermal resistance junction to sink ⁽²⁾	$R_{th(j-s)}$	$\lambda_{paste} = 3,4$ W/mK (PSX)						1,18		K/W
--	---------------	---------------------------------------	--	--	--	--	--	------	--	-----

Dynamic

Peak recovery current	I_{RRM}					25 125 150		127,5 144,14 151,04		A
Reverse recovery time	t_{rr}					25 125 150		41,24 50,9 59,39		ns
Recovered charge	Q_r	$di/dt=9519$ A/μs $di/dt=8125$ A/μs $di/dt=8584$ A/μs	-5/15	400	75	25 125 150		2,99 4,04 4,64		μC
Reverse recovered energy	E_{rec}					25 125 150		1,15 1,46 1,63		mWs
Peak rate of fall of recovery current	$(di_r/dt)_{max}$					25 125 150		5656,09 5975,69 5592,71		A/μs



Vincotech

Characteristic Values

Parameter	Symbol	Conditions					Values			Unit
		V_{GE} [V] V_{GS} [V]	V_{CE} [V] V_{DS} [V] V_F [V]	I_C [A] I_D [A] I_F [A]	T_j [°C]	Min	Typ	Max		

Boost Switch

Static

Gate-emitter threshold voltage	$V_{GE(th)}$		5	0,0504	25	5	6	7	V
Collector-emitter saturation voltage	$V_{CE(sat)}$	15		75	25 125 150		1,43 1,58 1,61	1,9 ⁽¹⁾	V
Collector-emitter cut-off current	I_{CES}	0	650		25			10	μA
Gate-emitter leakage current	I_{GES}	30	0		25			0,2	μA
Internal gate resistance	r_g						None		Ω

Thermal

Thermal resistance junction to sink ⁽²⁾	$R_{th(j-s)}$	$\lambda_{paste} = 3,4$ W/mK (PSX)					1,08		K/W
--	---------------	---------------------------------------	--	--	--	--	------	--	-----

Dynamic

Turn-on delay time	$t_{d(on)}$	$R_{gon} = 4 \Omega$ $R_{goff} = 4 \Omega$	-5/15	400	75	25		35,84		ns
						125		35,2		
						150		35,2		
Rise time	t_r					25		8,32		
						125		9,28		
						150		9,6		
Turn-off delay time	$t_{d(off)}$					25		86,08		ns
						125		97,92		
						150		100,8		
Fall time	t_f					25		54,7		ns
						125		39,49		
						150		43,15		
Turn-on energy (per pulse)	E_{on}	$Q_{ifwd}=3,3 \mu C$ $Q_{ifwd}=5,11 \mu C$ $Q_{ifwd}=5,37 \mu C$				25		0,341		mWs
						125		0,526		
						150		0,592		
Turn-off energy (per pulse)	E_{off}					25		1,22		mWs
						125		1,62		
						150		1,74		



Vincotech

Characteristic Values

Parameter	Symbol	Conditions					Values			Unit
		V_{GE} [V] V_{GS} [V]	V_{CE} [V] V_{DS} [V] V_F [V]	I_C [A] I_D [A] I_F [A]	T_j [°C]	Min	Typ	Max		
Boost Diode										
Static										
Forward voltage	V_F				80	25 125 150		1,55 1,62 1,61	1,9 ⁽¹⁾	V
Reverse leakage current	I_R	$V_i = 650$ V				25			10	μA
Thermal										
Thermal resistance junction to sink ⁽²⁾	$R_{th(j-s)}$	$\lambda_{paste} = 3,4$ W/mK (PSX)						1,18		K/W
Dynamic										
Peak recovery current	I_{RRM}					25 125 150		145,84 154,22 156,78		A
Reverse recovery time	t_{rr}					25 125 150		37,64 75,47 89,64		ns
Recovered charge	Q_r	$di/dt=9011$ A/μs $di/dt=8714$ A/μs $di/dt=8917$ A/μs	-5/15	400	75	25 125 150		3,3 5,11 5,37		μC
Reverse recovered energy	E_{rec}					25 125 150		1,01 1,56 1,61		mWs
Peak rate of fall of recovery current	$(di_r/dt)_{max}$					25 125 150		6366 6726 6282		A/μs



Characteristic Values

Parameter	Symbol	Conditions					Values			Unit
		V_{GS} [V]	V_{GE} [V]	V_{DS} [V]	V_{CE} [V]	T_j [°C]	Min	Typ	Max	

Thermistor

Static

Rated resistance	R					25		22		kΩ
Deviation of R_{100}	$A_{R/R}$	$R_{100} = 1484 \Omega$				100	-5		5	%
Power dissipation	P					25		130		mW
Power dissipation constant	d					25		1,5		mW/K
B-value	$B_{(25/50)}$	Tol. $\pm 1 \%$						3962		K
B-value	$B_{(25/100)}$	Tol. $\pm 1 \%$						4000		K
Vincotech Thermistor Reference									I	

⁽¹⁾ Value at chip level

⁽²⁾ Only valid with pre-applied Vincotech thermal interface material.



Buck Switch Characteristics

figure 1. IGBT

Typical output characteristics

$$I_C = f(V_{CE})$$

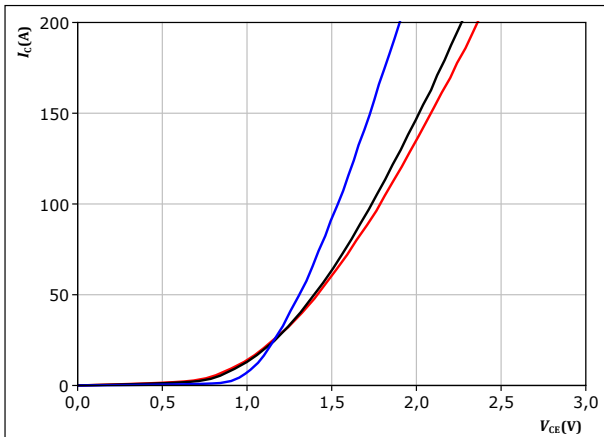

$t_p = 250 \mu s$
 $V_{GE} = 15 V$

T_j :
— 25 °C
— 125 °C
— 150 °C

figure 2. IGBT

Typical output characteristics

$$I_C = f(V_{CE})$$

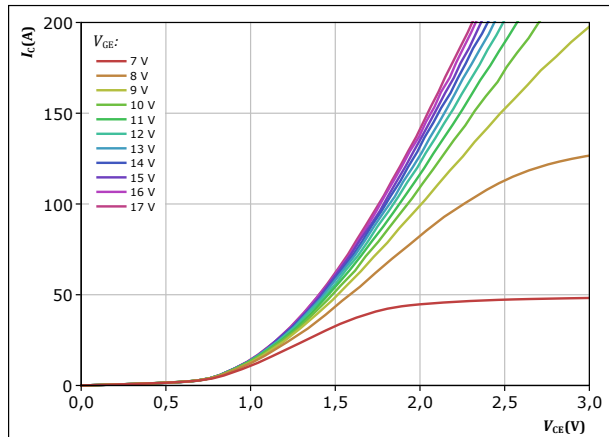

$t_p = 250 \mu s$
 $T_j = 150 \text{ }^\circ C$
 V_{GE} from 7 V to 17 V in steps of 1 V

figure 3. IGBT

Typical transfer characteristics

$$I_C = f(V_{GE})$$

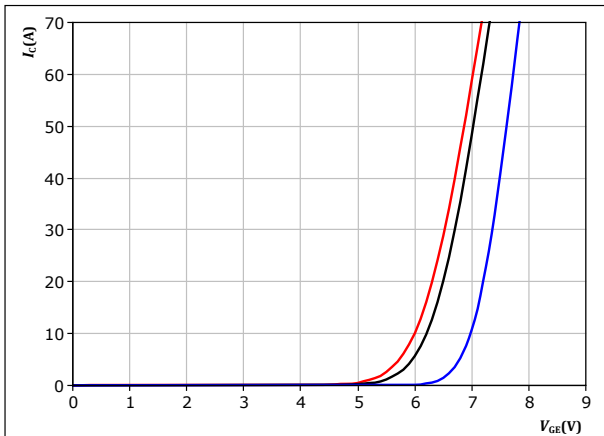

$t_p = 250 \mu s$
 $V_{CE} = 14 V$

T_j :
— 25 °C
— 125 °C
— 150 °C

figure 4. IGBT

Transient thermal impedance as a function of pulse width

$$Z_{th(j-s)} = f(t_p)$$

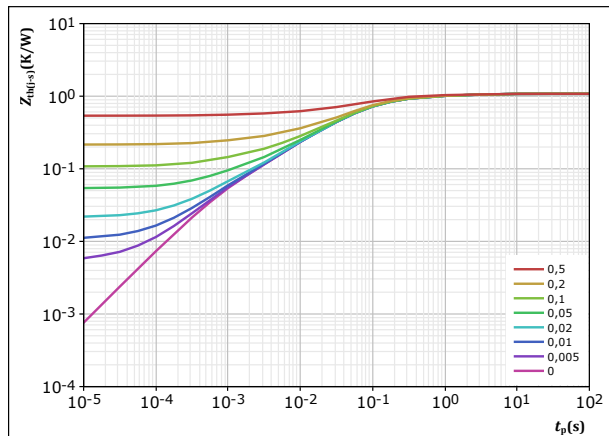

$D = t_p / T$
 $R_{th(j-s)} = 1,078 \text{ K/W}$

IGBT thermal model values

R (K/W)	τ (s)
8,14E-02	2,67E+00
1,88E-01	3,44E-01
6,08E-01	6,67E-02
1,59E-01	9,52E-03
4,09E-02	8,22E-04



Buck Switch Characteristics

figure 5. IGBT

Safe operating area

$$I_C = f(V_{CE})$$

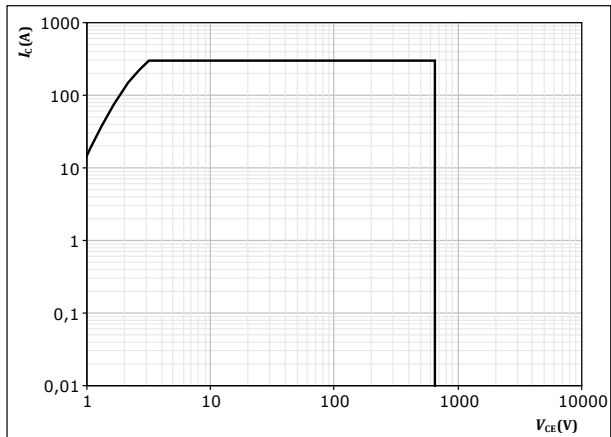

$D =$ single pulse
 $T_s = 80$ °C
 $V_{GE} = 15$ V
 $T_j = T_{jmax}$



Buck Diode Characteristics

figure 6. FWD

Typical forward characteristics

$$I_F = f(V_F)$$

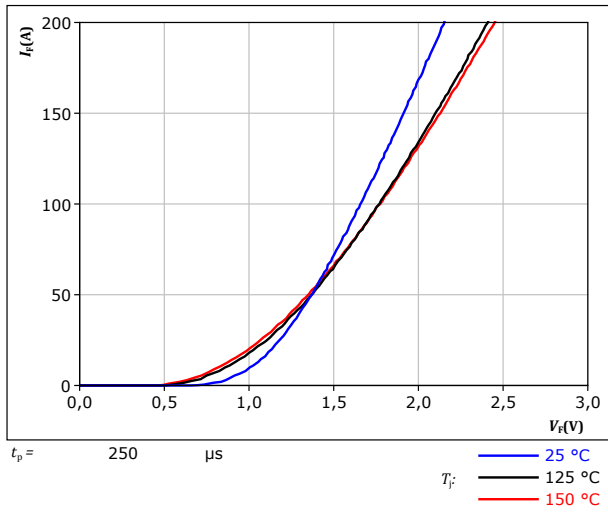
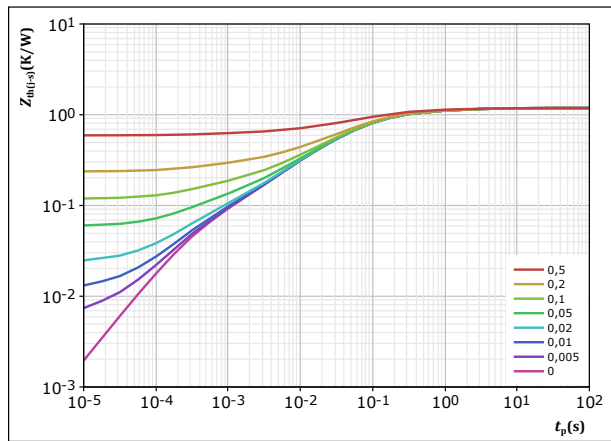

figure 7. FWD

Transient thermal impedance as a function of pulse width

$$Z_{th(j-s)} = f(t_p)$$



$D = t_p / T$
 $R_{th(j-s)} = 1,185 \text{ K/W}$

FWD thermal model values

$R \text{ (K/W)}$	$\tau \text{ (s)}$
5,19E-02	4,33E+00
1,00E-01	8,58E-01
2,79E-01	1,79E-01
4,49E-01	5,45E-02
2,02E-01	1,11E-02
5,43E-02	2,28E-03
4,85E-02	3,33E-04



Boost Switch Characteristics

figure 8. IGBT

Typical output characteristics

$I_C = f(V_{CE})$

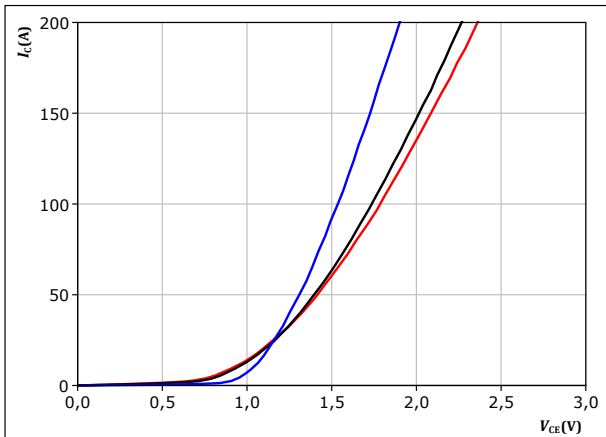

$t_p = 250 \mu s$
 $V_{GE} = 15 V$
 $T_j:$ 25 °C, 125 °C, 150 °C

figure 9. IGBT

Typical output characteristics

$I_C = f(V_{CE})$

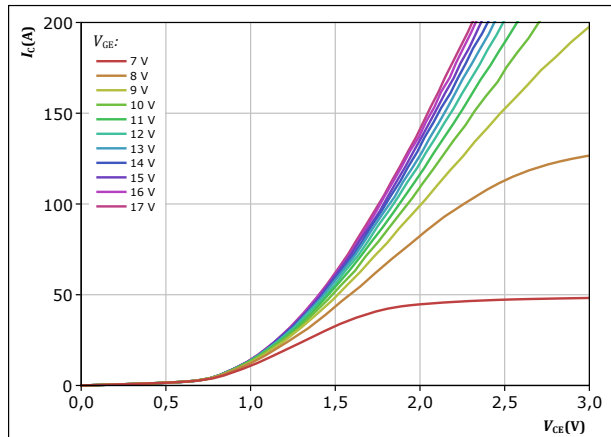

$t_p = 250 \mu s$
 $T_j = 150 \text{ °C}$
 V_{GE} from 7 V to 17 V in steps of 1 V

figure 10. IGBT

Typical transfer characteristics

$I_C = f(V_{GE})$

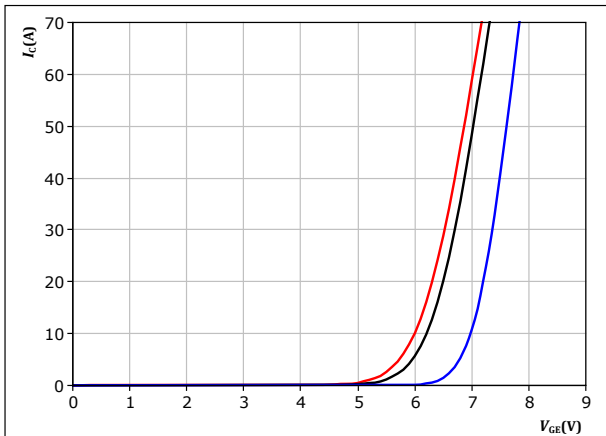

$t_p = 250 \mu s$
 $V_{CE} = 14 V$
 $T_j:$ 25 °C, 125 °C, 150 °C

figure 11. IGBT

Transient thermal impedance as a function of pulse width

$Z_{th(j-s)} = f(t_p)$

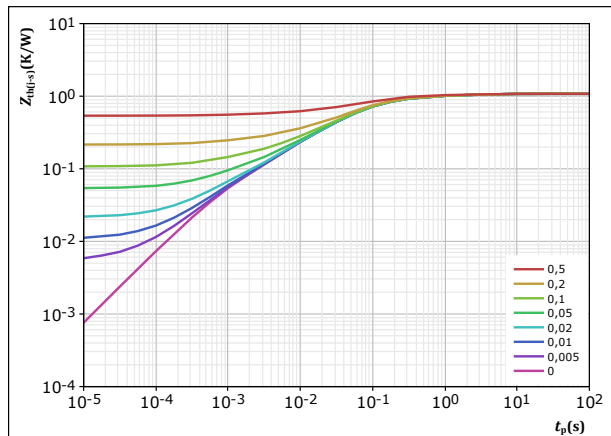

$D = t_p / T$
 $R_{th(j-s)} = 1,078 \text{ K/W}$
IGBT thermal model values

R (K/W)	τ (s)
8,14E-02	2,67E+00
1,88E-01	3,44E-01
6,08E-01	6,67E-02
1,59E-01	9,52E-03
4,09E-02	8,22E-04



Boost Switch Characteristics

figure 12. IGBT

Safe operating area

$$I_C = f(V_{CE})$$

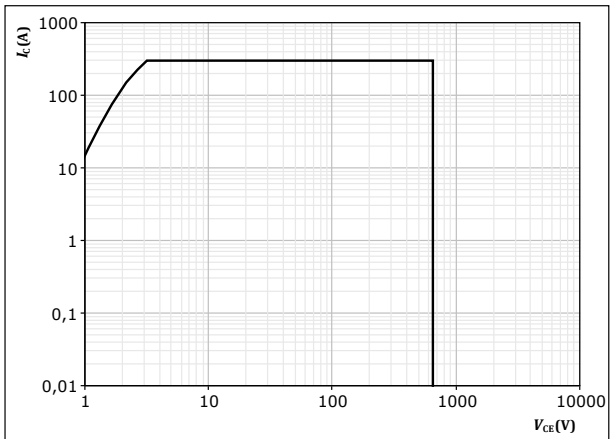

D = single pulse
T_s = 80 °C
V_{GE} = 15 V
T_j = T_{jmax}



Boost Diode Characteristics

figure 13. FWD

Typical forward characteristics

$$I_F = f(V_F)$$

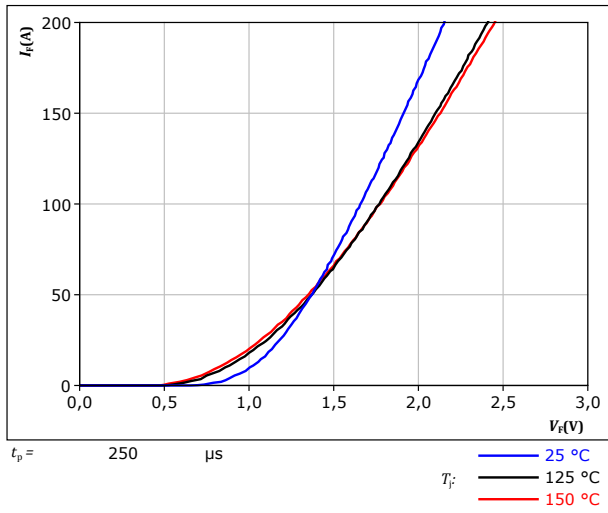
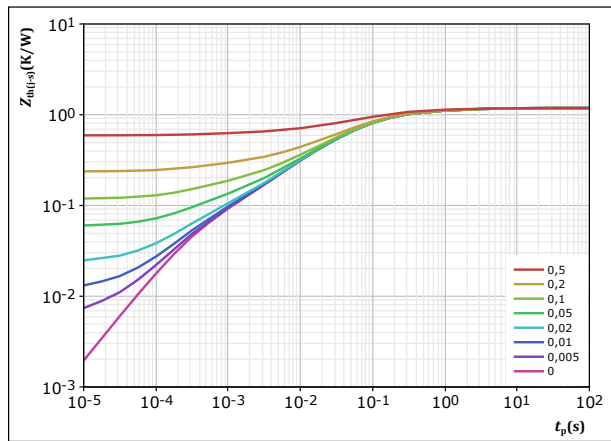

figure 14. FWD

Transient thermal impedance as a function of pulse width

$$Z_{th(j-s)} = f(t_p)$$



$D = t_p / T$
 $R_{th(j-s)} = 1,185$ K/W
 FWD thermal model values

R (K/W)	τ (s)
5,19E-02	4,33E+00
1,00E-01	8,58E-01
2,79E-01	1,79E-01
4,49E-01	5,45E-02
2,02E-01	1,11E-02
5,43E-02	2,28E-03
4,85E-02	3,33E-04



Thermistor Characteristics

figure 15. Thermistor

Typical NTC characteristic as function of temperature

$$R_T = f(T)$$

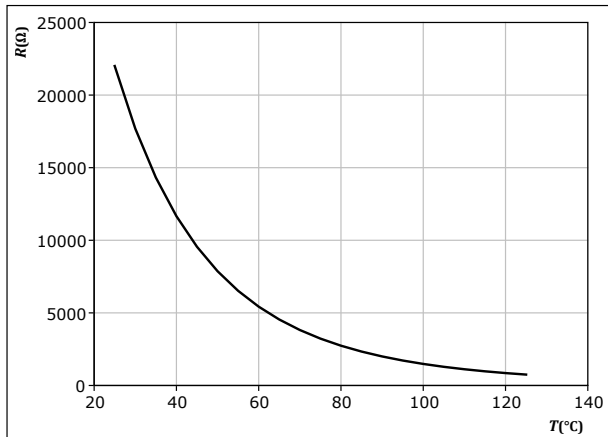



Buck Switching Characteristics

figure 16. IGBT

Typical switching energy losses as a function of collector current
 $E = f(I_c)$

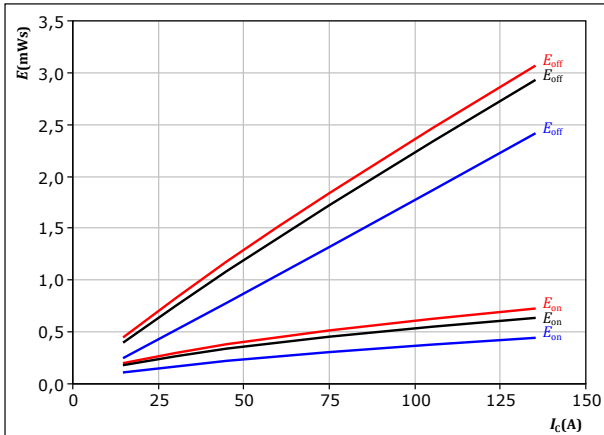

With an inductive load at
 $V_{CE} = 400 \text{ V}$
 $V_{GE} = -5/15 \text{ V}$
 $R_{gon} = 4 \ \Omega$
 $R_{goff} = 4 \ \Omega$

T_j : — 25 °C
— 125 °C
— 150 °C

figure 17. IGBT

Typical switching energy losses as a function of gate resistor
 $E = f(R_g)$

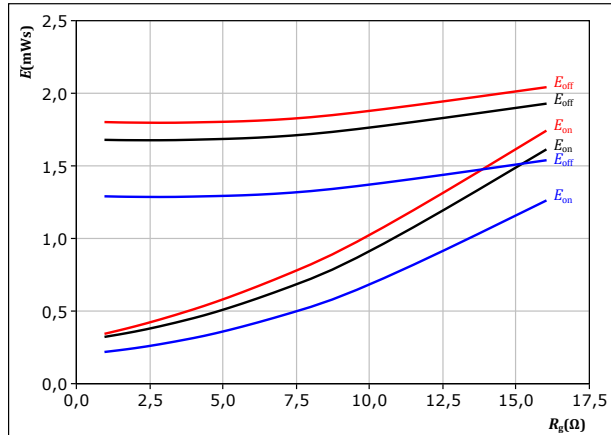

With an inductive load at
 $V_{CE} = 400 \text{ V}$
 $V_{GE} = -5/15 \text{ V}$
 $I_c = 75 \text{ A}$

T_j : — 25 °C
— 125 °C
— 150 °C

figure 18. FWD

Typical reverse recovered energy loss as a function of collector current
 $E_{rec} = f(I_c)$

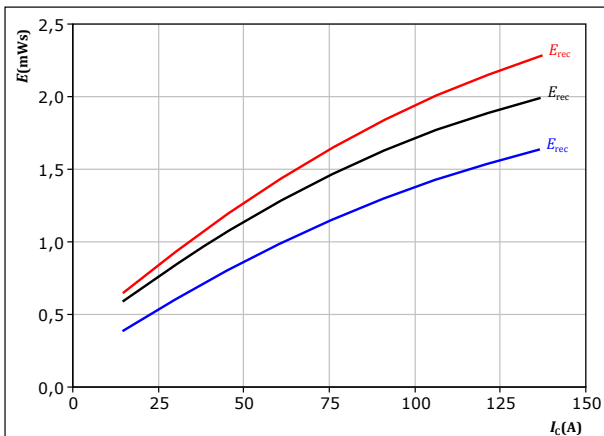

With an inductive load at
 $V_{CE} = 400 \text{ V}$
 $V_{GE} = -5/15 \text{ V}$
 $R_{gon} = 4 \ \Omega$

T_j : — 25 °C
— 125 °C
— 150 °C

figure 19. FWD

Typical reverse recovered energy loss as a function of gate resistor
 $E_{rec} = f(R_g)$

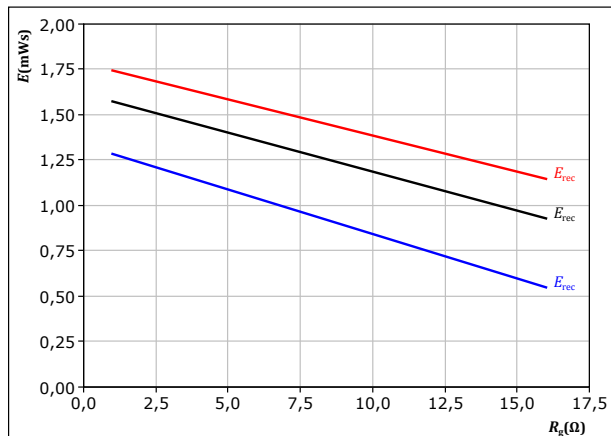

With an inductive load at
 $V_{CE} = 400 \text{ V}$
 $V_{GE} = -5/15 \text{ V}$
 $I_c = 75 \text{ A}$

T_j : — 25 °C
— 125 °C
— 150 °C



Buck Switching Characteristics

figure 20. IGBT

Typical switching times as a function of collector current
 $t = f(I_c)$

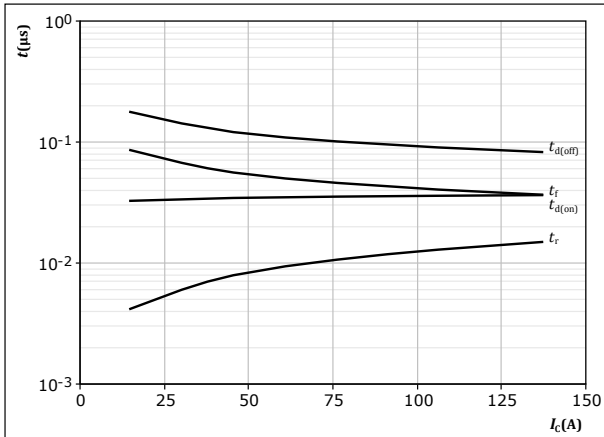

With an inductive load at
 $T_j = 150 \text{ }^\circ\text{C}$
 $V_{CE} = 400 \text{ V}$
 $V_{GE} = -5/15 \text{ V}$
 $R_{gon} = 4 \text{ } \Omega$
 $R_{goff} = 4 \text{ } \Omega$

figure 21. IGBT

Typical switching times as a function of gate resistor
 $t = f(R_g)$

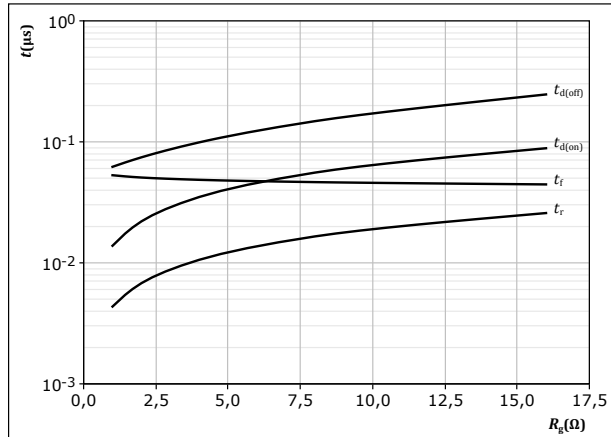

With an inductive load at
 $T_j = 150 \text{ }^\circ\text{C}$
 $V_{CE} = 400 \text{ V}$
 $V_{GE} = -5/15 \text{ V}$
 $I_c = 75 \text{ A}$

figure 22. FWD

Typical reverse recovery time as a function of collector current
 $t_{rr} = f(I_c)$

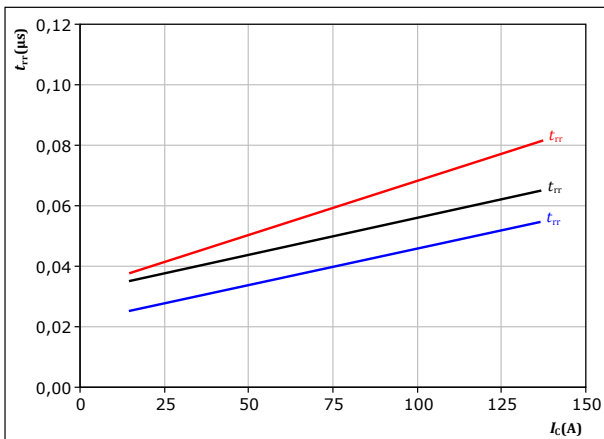

With an inductive load at
 $V_{CE} = 400 \text{ V}$
 $V_{GE} = -5/15 \text{ V}$
 $R_{gon} = 4 \text{ } \Omega$

T_j :
— 25 $^\circ\text{C}$
— 125 $^\circ\text{C}$
— 150 $^\circ\text{C}$

figure 23. FWD

Typical reverse recovery time as a function of IGBT turn off gate resistor
 $t_{rr} = f(R_{goff})$

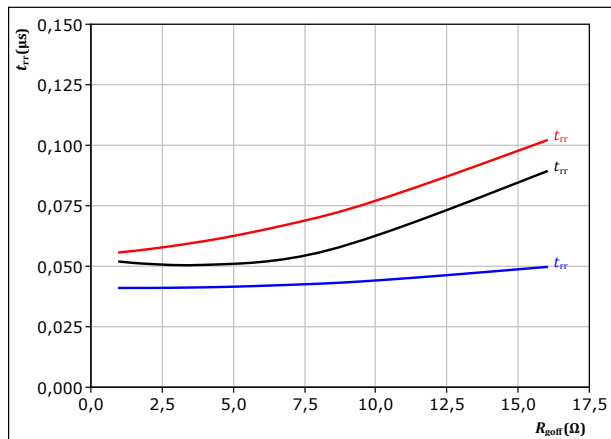

With an inductive load at
 $V_{CE} = 400 \text{ V}$
 $V_{GE} = -5/15 \text{ V}$
 $I_c = 75 \text{ A}$

T_j :
— 25 $^\circ\text{C}$
— 125 $^\circ\text{C}$
— 150 $^\circ\text{C}$



Buck Switching Characteristics

figure 24. FWD

Typical recovered charge as a function of collector current

$$Q_r = f(I_c)$$

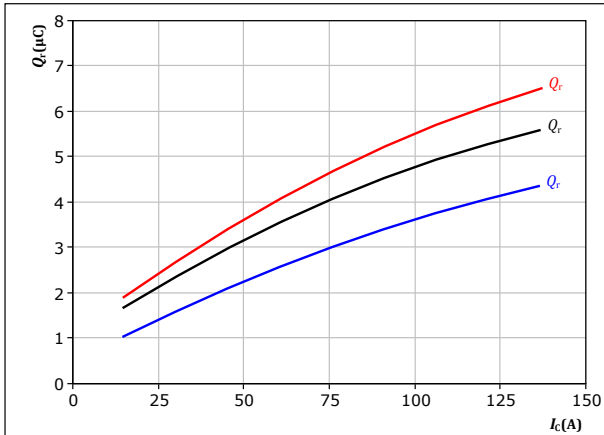

With an inductive load at

$V_{CE} = 400$ V
 $V_{GE} = -5/15$ V
 $R_{goff} = 4$ Ω
 T_j : 25 °C (blue), 125 °C (black), 150 °C (red)

figure 26. FWD

Typical peak reverse recovery current as a function of collector current

$$I_{RM} = f(I_c)$$

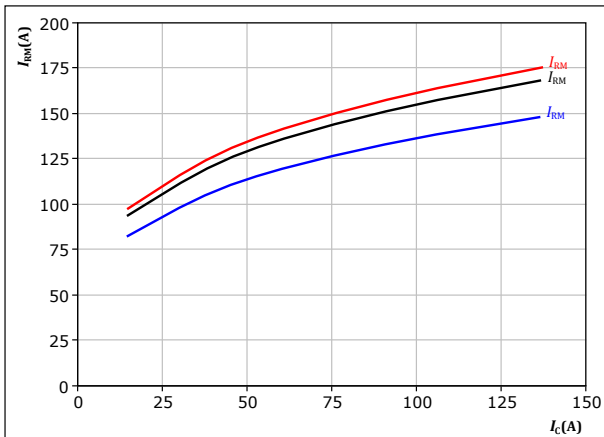

With an inductive load at

$V_{CE} = 400$ V
 $V_{GE} = -5/15$ V
 $R_{goff} = 4$ Ω
 T_j : 25 °C (blue), 125 °C (black), 150 °C (red)

figure 25. FWD

Typical recovered charge as a function of turn off gate resistor

$$Q_r = f(R_{goff})$$

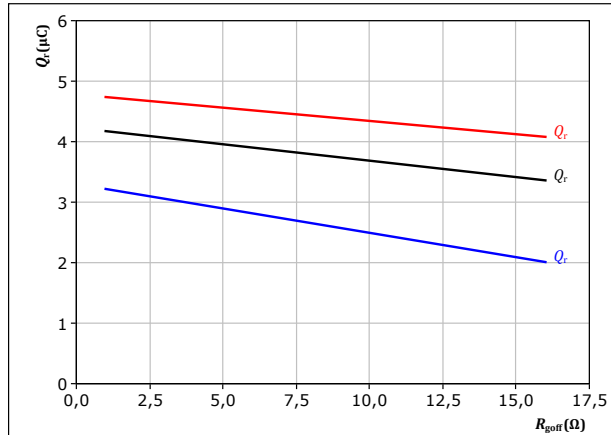

With an inductive load at

$V_{CE} = 400$ V
 $V_{GE} = -5/15$ V
 $I_c = 75$ A
 T_j : 25 °C (blue), 125 °C (black), 150 °C (red)

figure 27. FWD

Typical peak reverse recovery current as a function of turn off gate resistor

$$I_{RM} = f(R_{goff})$$

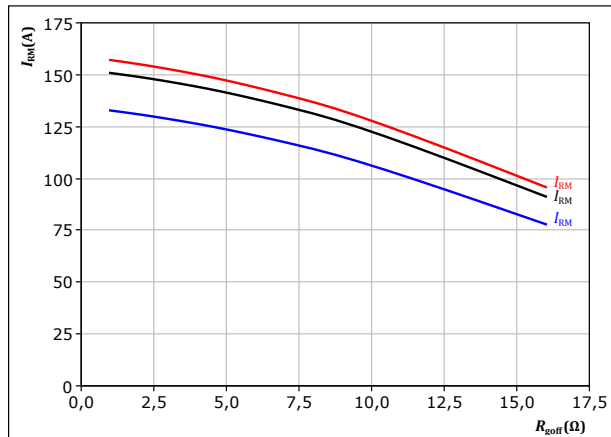

With an inductive load at

$V_{CE} = 400$ V
 $V_{GE} = -5/15$ V
 $I_c = 75$ A
 T_j : 25 °C (blue), 125 °C (black), 150 °C (red)



Buck Switching Characteristics

figure 28. FWD

Typical rate of fall of forward and reverse recovery current as a function of collector current
 $di_f/dt, di_r/dt = f(I_c)$

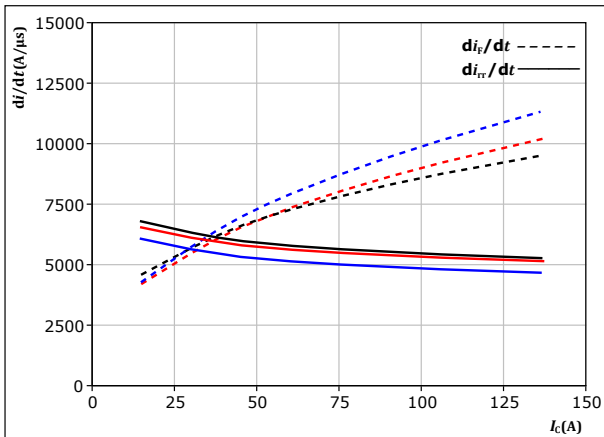

With an inductive load at

$V_{CE} = 400 \text{ V}$
 $V_{GE} = -5/15 \text{ V}$
 $R_{goff} = 4 \text{ } \Omega$

$T_j = 25 \text{ } ^\circ\text{C}$ (blue)
 $125 \text{ } ^\circ\text{C}$ (black)
 $150 \text{ } ^\circ\text{C}$ (red)

figure 29. FWD

Typical rate of fall of forward and reverse recovery current as a function of turn off gate resistor
 $di_f/dt, di_r/dt = f(R_{goff})$

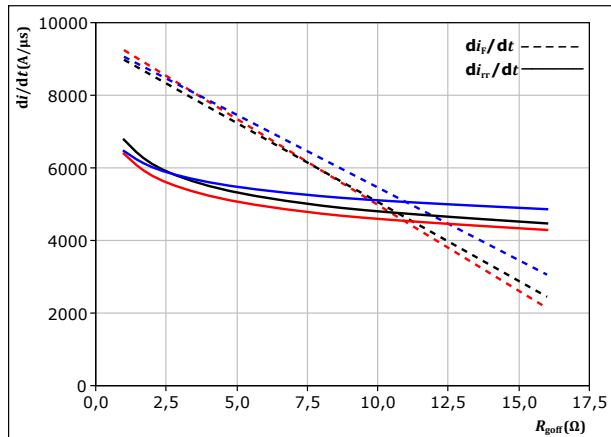

With an inductive load at

$V_{CE} = 400 \text{ V}$
 $V_{GE} = -5/15 \text{ V}$
 $I_c = 75 \text{ A}$

$T_j = 25 \text{ } ^\circ\text{C}$ (blue)
 $125 \text{ } ^\circ\text{C}$ (black)
 $150 \text{ } ^\circ\text{C}$ (red)

figure 30. IGBT

Reverse bias safe operating area

$I_c = f(V_{CE})$

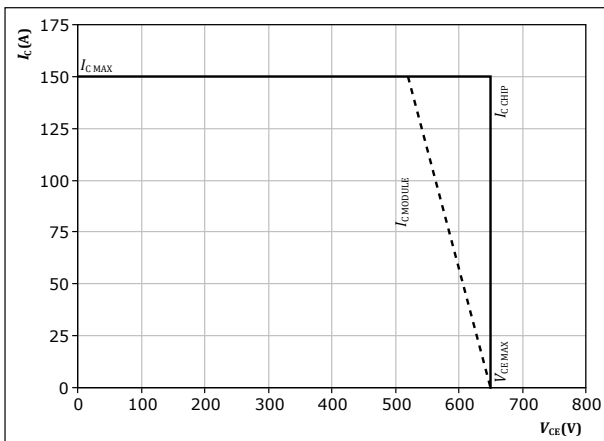

At $T_j = 150 \text{ } ^\circ\text{C}$
 $R_{goff} = 4 \text{ } \Omega$
 $R_{goff} = 4 \text{ } \Omega$



Boost Switching Characteristics

figure 31. IGBT

Typical switching energy losses as a function of collector current
 $E = f(I_c)$

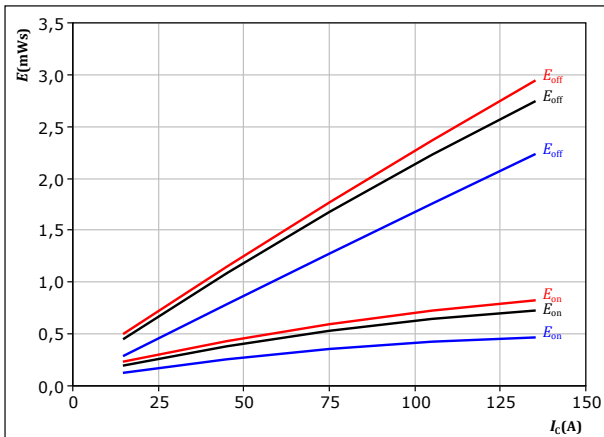

With an inductive load at
 $V_{CE} = 400$ V
 $V_{GE} = -5/15$ V
 $R_{gon} = 4$ Ω
 $R_{goff} = 4$ Ω

T_j : 25 °C (blue), 125 °C (black), 150 °C (red)

figure 32. IGBT

Typical switching energy losses as a function of gate resistor
 $E = f(R_g)$

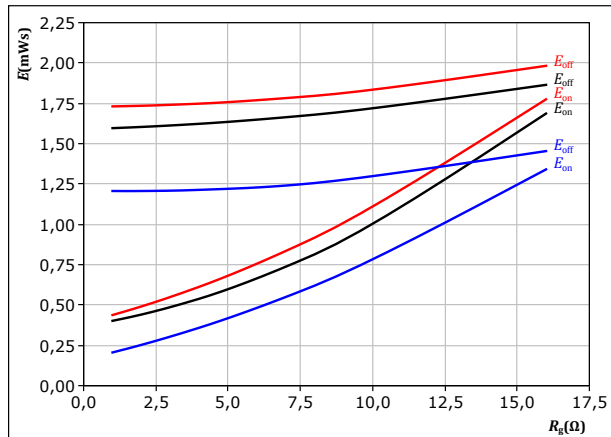

With an inductive load at
 $V_{CE} = 400$ V
 $V_{GE} = -5/15$ V
 $I_c = 75$ A

T_j : 25 °C (blue), 125 °C (black), 150 °C (red)

figure 33. FWD

Typical reverse recovered energy loss as a function of collector current
 $E_{rec} = f(I_c)$

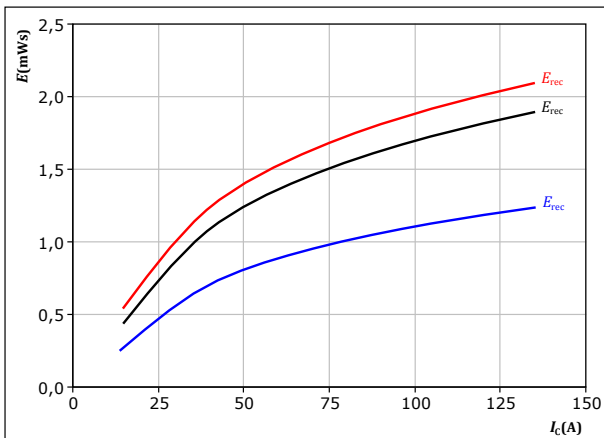

With an inductive load at
 $V_{CE} = 400$ V
 $V_{GE} = -5/15$ V
 $R_{gon} = 4$ Ω

T_j : 25 °C (blue), 125 °C (black), 150 °C (red)

figure 34. FWD

Typical reverse recovered energy loss as a function of gate resistor
 $E_{rec} = f(R_g)$

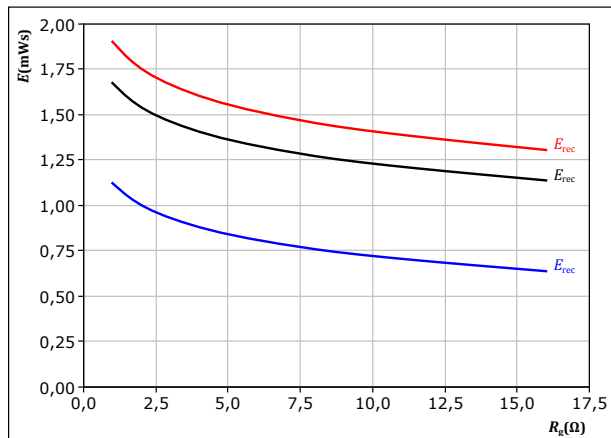

With an inductive load at
 $V_{CE} = 400$ V
 $V_{GE} = -5/15$ V
 $I_c = 75$ A

T_j : 25 °C (blue), 125 °C (black), 150 °C (red)



Boost Switching Characteristics

figure 35. IGBT

Typical switching times as a function of collector current
 $t = f(I_c)$

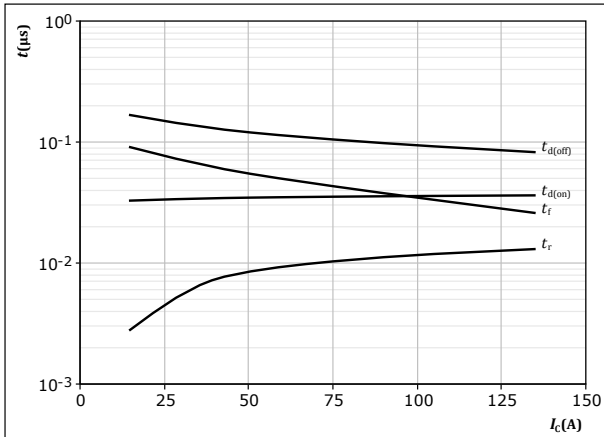

With an inductive load at
 $T_j = 150 \text{ }^\circ\text{C}$
 $V_{CE} = 400 \text{ V}$
 $V_{GE} = -5/15 \text{ V}$
 $R_{g(on)} = 4 \text{ } \Omega$
 $R_{g(off)} = 4 \text{ } \Omega$

figure 36. IGBT

Typical switching times as a function of gate resistor
 $t = f(R_g)$

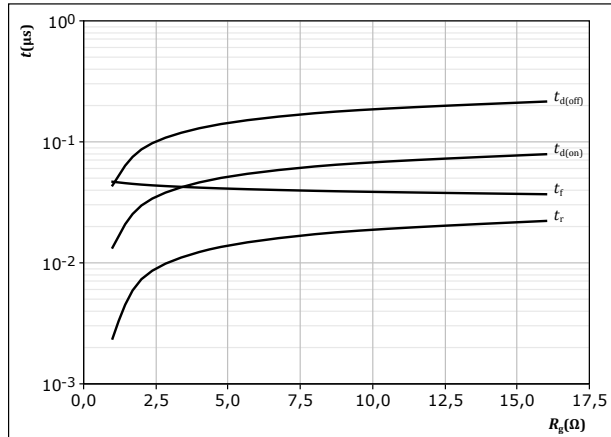

With an inductive load at
 $T_j = 150 \text{ }^\circ\text{C}$
 $V_{CE} = 400 \text{ V}$
 $V_{GE} = -5/15 \text{ V}$
 $I_c = 75 \text{ A}$

figure 37. FWD

Typical reverse recovery time as a function of collector current
 $t_{rr} = f(I_c)$

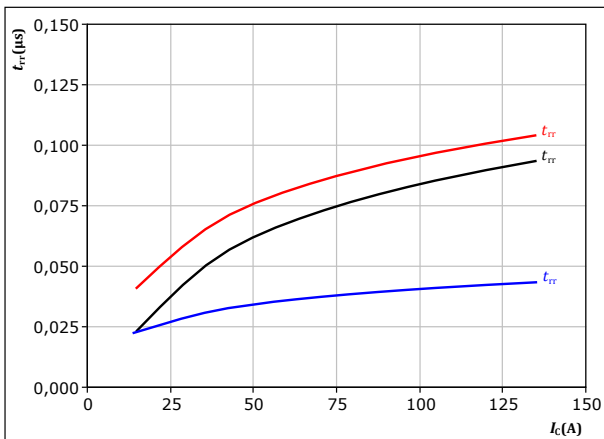

With an inductive load at
 $V_{CE} = 400 \text{ V}$
 $V_{GE} = -5/15 \text{ V}$
 $R_{g(on)} = 4 \text{ } \Omega$

T_j : — 25 $^\circ\text{C}$
 — 125 $^\circ\text{C}$
 — 150 $^\circ\text{C}$

figure 38. FWD

Typical reverse recovery time as a function of IGBT turn off gate resistor
 $t_{rr} = f(R_{g(off)})$

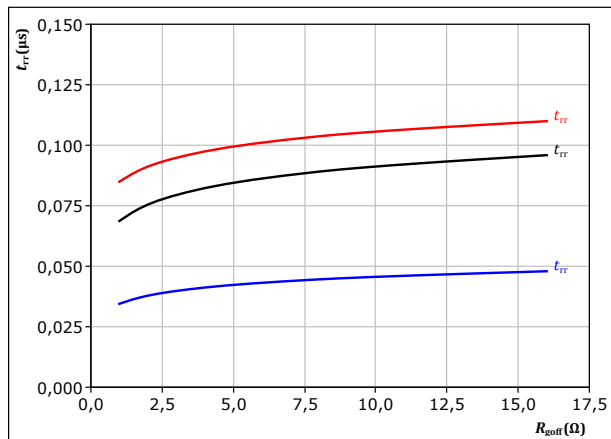

With an inductive load at
 $V_{CE} = 400 \text{ V}$
 $V_{GE} = -5/15 \text{ V}$
 $I_c = 75 \text{ A}$

T_j : — 25 $^\circ\text{C}$
 — 125 $^\circ\text{C}$
 — 150 $^\circ\text{C}$



Boost Switching Characteristics

figure 39. FWD

Typical recovered charge as a function of collector current

$$Q_r = f(I_c)$$

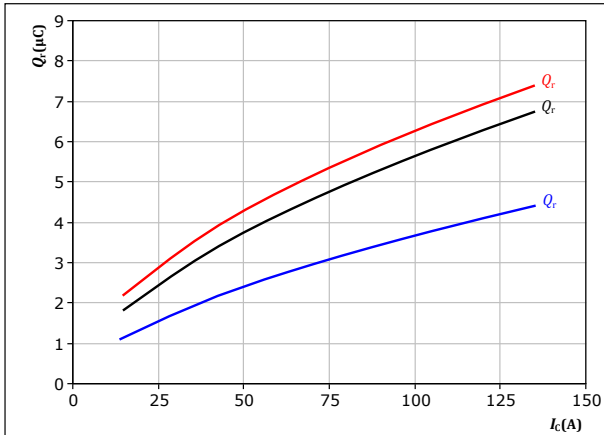

With an inductive load at

$V_{CE} = 400 \text{ V}$
 $V_{GE} = -5/15 \text{ V}$
 $R_{goff} = 4 \ \Omega$

T_j : — 25 °C
— 125 °C
— 150 °C

figure 40. FWD

Typical recovered charge as a function of turn off gate resistor

$$Q_r = f(R_{goff})$$

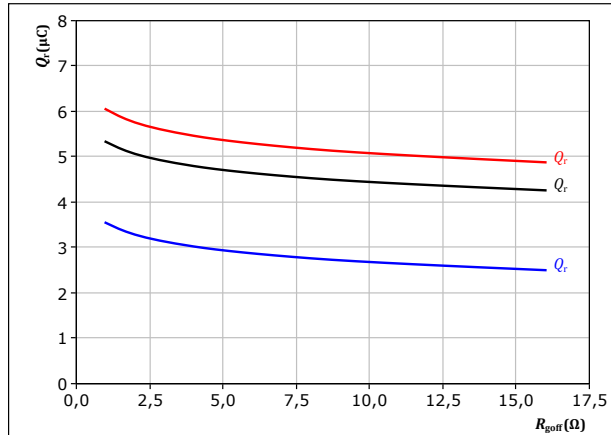

With an inductive load at

$V_{CE} = 400 \text{ V}$
 $V_{GE} = -5/15 \text{ V}$
 $I_c = 75 \text{ A}$

T_j : — 25 °C
— 125 °C
— 150 °C

figure 41. FWD

Typical peak reverse recovery current as a function of collector current

$$I_{RM} = f(I_c)$$

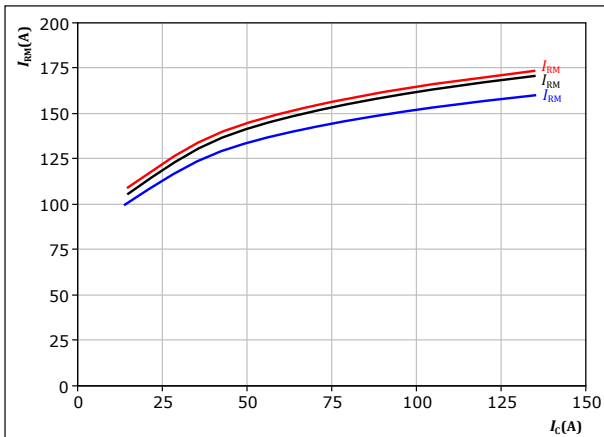

With an inductive load at

$V_{CE} = 400 \text{ V}$
 $V_{GE} = -5/15 \text{ V}$
 $R_{goff} = 4 \ \Omega$

T_j : — 25 °C
— 125 °C
— 150 °C

figure 42. FWD

Typical peak reverse recovery current as a function of turn off gate resistor

$$I_{RM} = f(R_{goff})$$

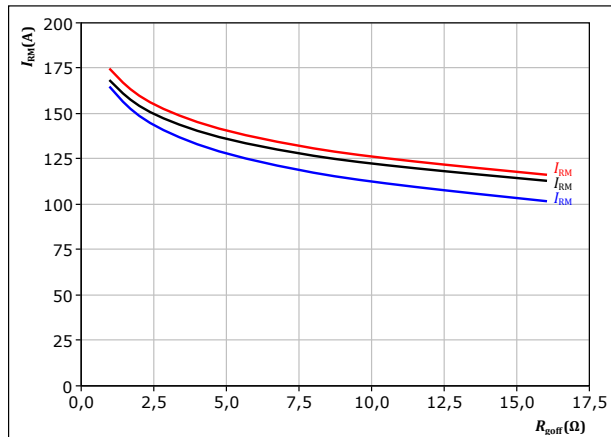

With an inductive load at

$V_{CE} = 400 \text{ V}$
 $V_{GE} = -5/15 \text{ V}$
 $I_c = 75 \text{ A}$

T_j : — 25 °C
— 125 °C
— 150 °C



Boost Switching Characteristics

figure 43. FWD

Typical rate of fall of forward and reverse recovery current as a function of collector current
 $di_f/dt, di_r/dt = f(I_c)$

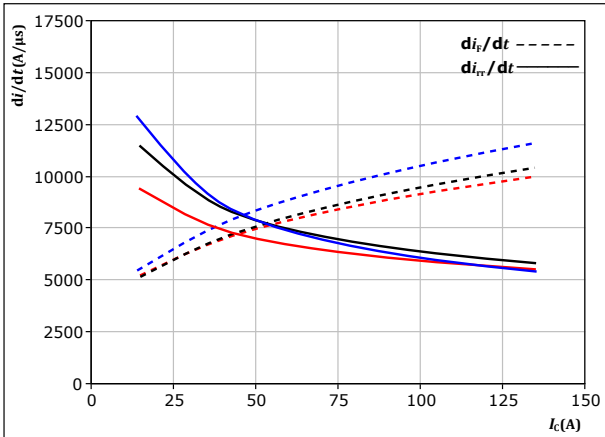

With an inductive load at

$V_{CE} = 400 \text{ V}$
 $V_{GE} = -5/15 \text{ V}$
 $R_{goff} = 4 \text{ } \Omega$

T_j : 25 °C
 125 °C
 150 °C

figure 44. FWD

Typical rate of fall of forward and reverse recovery current as a function of turn off gate resistor
 $di_f/dt, di_r/dt = f(R_{goff})$

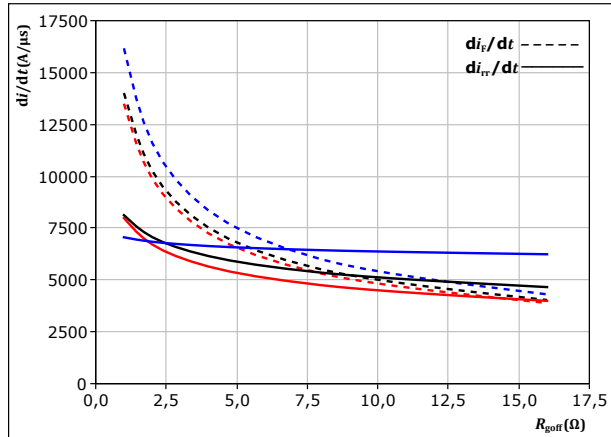

With an inductive load at

$V_{CE} = 400 \text{ V}$
 $V_{GE} = -5/15 \text{ V}$
 $I_c = 75 \text{ A}$

T_j : 25 °C
 125 °C
 150 °C

figure 45. IGBT

Reverse bias safe operating area

$I_c = f(V_{CE})$

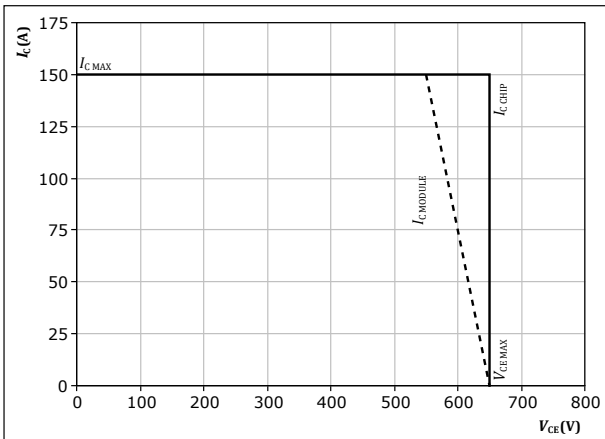

At $T_j = 150 \text{ } ^\circ\text{C}$
 $R_{goff} = 4 \text{ } \Omega$
 $R_{goff} = 4 \text{ } \Omega$



Switching Definitions

figure 46. IGBT
Turn-off Switching Waveforms & definition of t_{doff} , t_{Eoff} (t_{Eoff} = integrating time for E_{off})

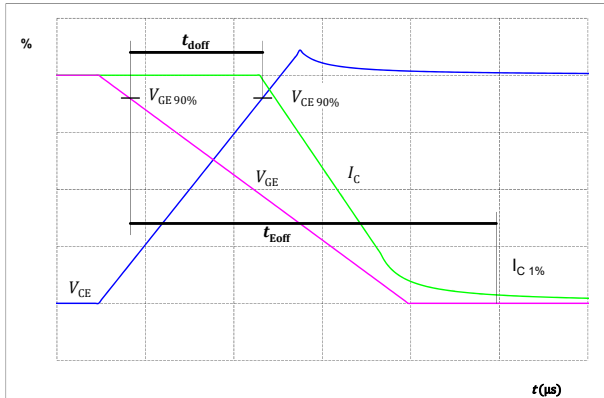

figure 47. IGBT
Turn-on Switching Waveforms & definition of t_{don} , t_{Eon} (t_{Eon} = integrating time for E_{on})

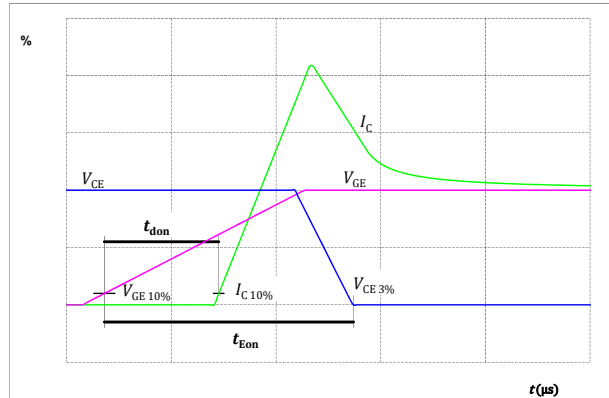

figure 48. IGBT
Turn-off Switching Waveforms & definition of t_f

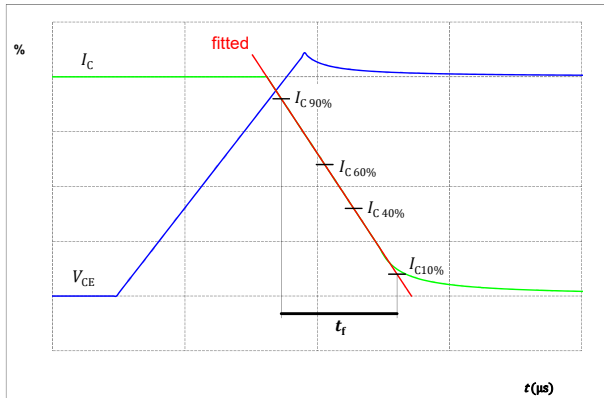
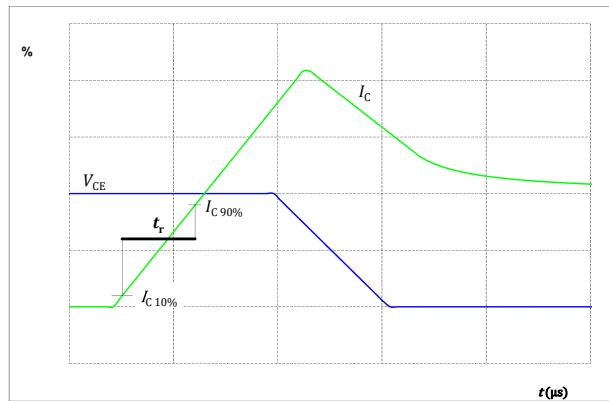

figure 49. IGBT
Turn-on Switching Waveforms & definition of t_r





Switching Definitions

figure 50. FWD

Turn-off Switching Waveforms & definition of t_{rr}

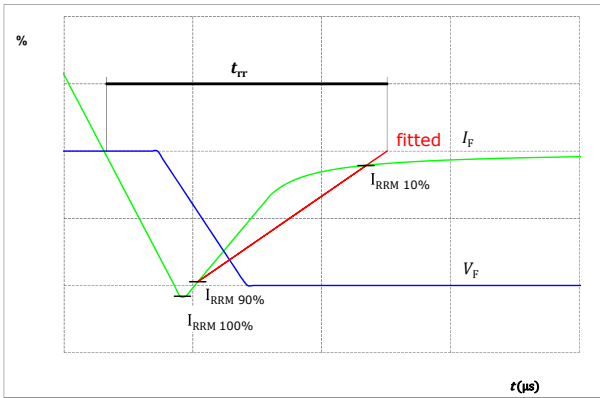
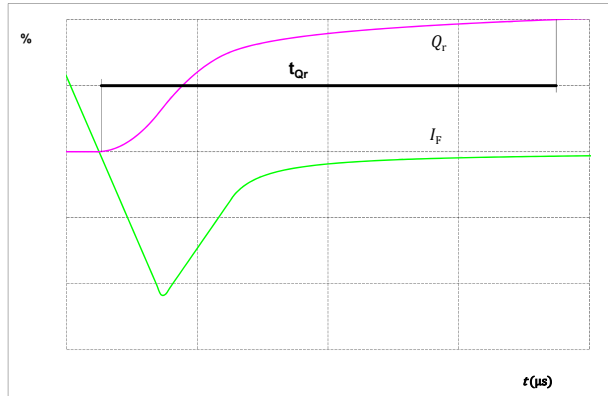

figure 51. FWD

Turn-on Switching Waveforms & definition of t_{Qr} (t_{Qr} = integrating time for Q_r)





Vincotech

10-FY07HVA075RG01-L985F48
datasheet

Ordering Code	
Version	Ordering Code
Without thermal paste	10-FY07HVA075RG01-L985F48
With thermal paste (5,2 W/mK, PTM6000HV)	10-FY07HVA075RG01-L985F48-/7/
With thermal paste (3,4 W/mK, PSX-P7)	10-FY07HVA075RG01-L985F48-/3/

Marking						
	Text	Name NN-NNNNNNNNNNNNNN- TTTTTIVV	Date code WWYY	UL & VIN UL VIN	Lot LLLLL	Serial SSSS
	Datamatrix	Type&Ver TTTTTIVV	Lot number LLLLL	Serial SSSS	Date code WWYY	

Pin table [mm]			
Pin	X	Y	Function
1	52,2	0	G14
2	49,2	0	S14
3	not assembled		
4	26,1	0	Therm2
5	23,1	0	Therm1
6	3	0	S12
7	0	0	G12
8	0	8	DC+
9	0	10,5	DC+
10	0	17,7	DC-1
11	0	20,2	DC-1
12	0	28,2	G11
13	3	28,2	S11
14	10	28,2	G21
15	13	28,2	S21
16	20,35	28,2	Ph2
17	22,85	28,2	Ph2
18	29,35	28,2	Ph1
19	31,85	28,2	Ph1
20	39,2	28,2	S22
21	42,2	28,2	G22
22	49,2	28,2	S13
23	52,2	28,2	G13
24	52,2	20,2	DC-2
25	52,2	17,7	DC-2
26	52,2	10,5	DC+
27	52,2	8	DC+
28	26,1	22,1	A20

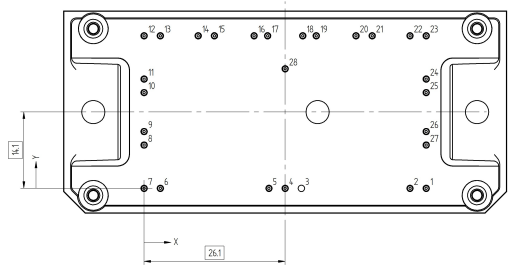
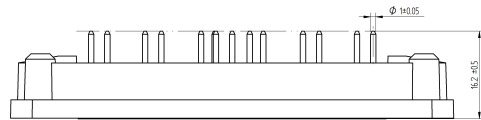

Tolerance of pinpositions: ±0.5mm of the end of pins
Dimension of coordinate axis is only ordinal without tolerance



Vincotech

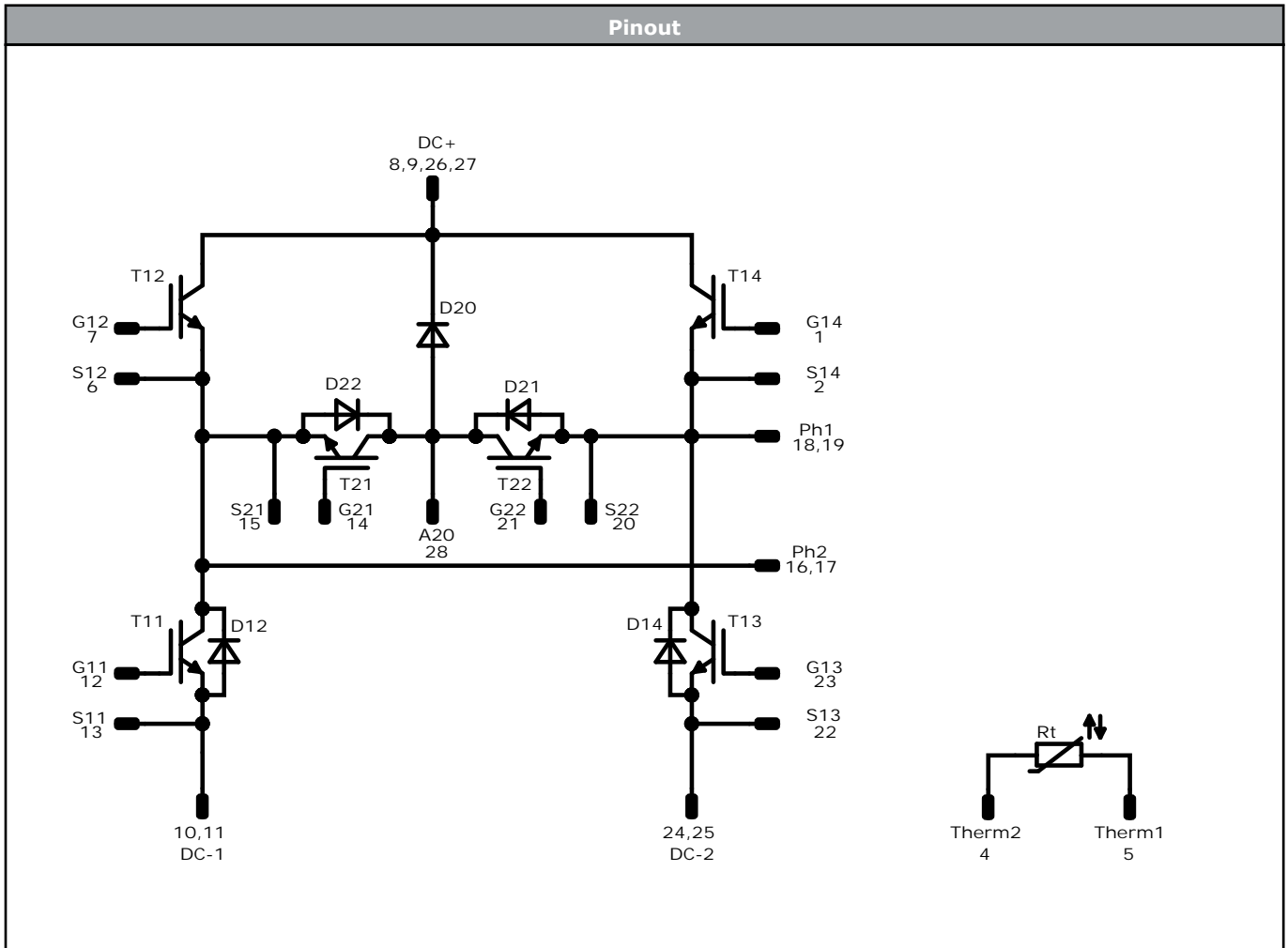

Identification					
ID	Component	Voltage	Current	Function	Comment
T11, T13, T12, T14	IGBT	650 V	75 A	Buck Switch	
D22, D21	FWD	650 V	80 A	Buck Diode	
T21, T22	IGBT	650 V	75 A	Boost Switch	
D12, D14, D20	FWD	650 V	80 A	Boost Diode	
Rt	Thermistor			Thermistor	



Vincotech

Packaging instruction				
Standard packaging quantity (SPQ) 100	>SPQ	Standard	<SPQ	Sample

Handling instruction
Handling instructions for <i>flow 1</i> packages see vincotech.com website.

Package data
Package data for <i>flow 1</i> packages see vincotech.com website.

Vincotech thermistor reference
See Vincotech thermistor reference table at vincotech.com website.

UL recognition and file number
This device is certified according to UL 1557 standard, UL file number E192116. For more information see vincotech.com website. 

Document No.:	Date:	Modification:	Pages
10-FY07HVA075RG01-L985F48-D1-14	23 Jan. 2022	Initial Release	

DISCLAIMER

The information, specifications, procedures, methods and recommendations herein (together "information") are presented by Vincotech to reader in good faith, are believed to be accurate and reliable, but may well be incomplete and/or not applicable to all conditions or situations that may exist or occur. Vincotech reserves the right to make any changes without further notice to any products to improve reliability, function or design. No representation, guarantee or warranty is made to reader as to the accuracy, reliability or completeness of said information or that the application or use of any of the same will avoid hazards, accidents, losses, damages or injury of any kind to persons or property or that the same will not infringe third parties rights or give desired results. It is reader's sole responsibility to test and determine the suitability of the information and the product for reader's intended use.

LIFE SUPPORT POLICY

Vincotech products are not authorised for use as critical components in life support devices or systems without the express written approval of Vincotech.

As used herein:

1. Life support devices or systems are devices or systems which, (a) are intended for surgical implant into the body, or (b) support or sustain life, or (c) whose failure to perform when properly used in accordance with instructions for use provided in labelling can be reasonably expected to result in significant injury to the user.
2. A critical component is any component of a life support device or system whose failure to perform can be reasonably expected to cause the failure of the life support device or system, or to affect its safety or effectiveness.