



flow3xANPFC 1

650 V / 50 A

Topology features

- 3x Advanced Neutral Boost PFC
- Temperature sensor

Component features

- High efficiency in hard switching and resonant topologies
- High speed switching
- Low gate charge

Housing features

- Base isolation: Al₂O₃
- Convex shaped substrate for superior thermal contact
- Thermo-mechanical push-and-pull force relief
- Press-fit pin
- Reliable cold welding connection

Target applications

- Charging Stations
- Power Supply

Types

- 10-PY073AA050RG02-LK14L03Y

flow 1 12 mm housing



Schematic

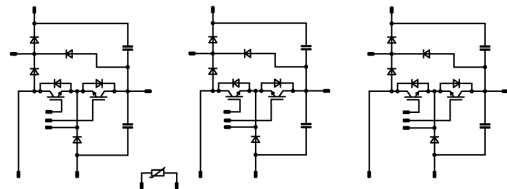



Vincotech

Maximum Ratings

$T_j = 25\text{ °C}$, unless otherwise specified

Parameter	Symbol	Conditions	Value	Unit
Negative Neutral Point Switch				
Collector-emitter voltage	V_{CES}		650	V
Collector current (DC current)	I_C	$T_j = T_{jmax}$ $T_s = 80\text{ °C}$	46	A
Repetitive peak collector current	I_{CRM}	t_p limited by T_{jmax}	200	A
Total power dissipation	P_{tot}	$T_j = T_{jmax}$ $T_s = 80\text{ °C}$	77	W
Gate-emitter voltage	V_{GES}		± 30	V
Maximum junction temperature	T_{jmax}		175	°C
Positive Neutral Point Switch				
Collector-emitter voltage	V_{CES}		650	V
Collector current (DC current)	I_C	$T_j = T_{jmax}$ $T_s = 80\text{ °C}$	46	A
Repetitive peak collector current	I_{CRM}	t_p limited by T_{jmax}	200	A
Total power dissipation	P_{tot}	$T_j = T_{jmax}$ $T_s = 80\text{ °C}$	77	W
Gate-emitter voltage	V_{GES}		± 30	V
Maximum junction temperature	T_{jmax}		175	°C
Negative Boost Diode				
Peak repetitive reverse voltage	V_{RRM}		650	V
Forward current (DC current)	I_F	$T_j = T_{jmax}$ $T_s = 80\text{ °C}$	29	A
Repetitive peak forward current	I_{FRM}	t_p limited by T_{jmax}	80	A
Surge (non-repetitive) forward current	I_{FSM}	Single Half Sine Wave, $t_p = 8,3\text{ ms}$ $T_j = 25\text{ °C}$	80	A
Total power dissipation	P_{tot}	$T_j = T_{jmax}$ $T_s = 80\text{ °C}$	57	W
Maximum junction temperature	T_{jmax}		175	°C



Vincotech

Maximum Ratings

$T_j = 25\text{ °C}$, unless otherwise specified

Parameter	Symbol	Conditions	Value	Unit
Positive Boost Diode				
Peak repetitive reverse voltage	V_{RRM}		650	V
Forward current (DC current)	I_F	$T_j = T_{jmax}$ $T_s = 80\text{ °C}$	29	A
Repetitive peak forward current	I_{FRM}	i_p limited by T_{jmax}	80	A
Surge (non-repetitive) forward current	I_{FSM}	Single Half Sine Wave, $t_p = 8,3\text{ ms}$ $T_j = 25\text{ °C}$	80	A
Total power dissipation	P_{tot}	$T_j = T_{jmax}$ $T_s = 80\text{ °C}$	57	W
Maximum junction temperature	T_{jmax}		175	°C
Negative Neutral Point Diode				
Peak repetitive reverse voltage	V_{RRM}		1600	V
Forward current (DC current)	I_F	$T_j = T_{jmax}$ $T_s = 80\text{ °C}$	44	A
Surge (non-repetitive) forward current	I_{FSM}	Single Half Sine Wave, $t_p = 10\text{ ms}$ $T_j = 150\text{ °C}$	270	A
Surge current capability	I^2t		370	A ² s
Total power dissipation	P_{tot}	$T_j = T_{jmax}$ $T_s = 80\text{ °C}$	51	W
Maximum junction temperature	T_{jmax}		150	°C
Positive Neutral Point Diode				
Peak repetitive reverse voltage	V_{RRM}		1600	V
Forward current (DC current)	I_F	$T_j = T_{jmax}$ $T_s = 80\text{ °C}$	44	A
Surge (non-repetitive) forward current	I_{FSM}	Single Half Sine Wave, $t_p = 10\text{ ms}$ $T_j = 150\text{ °C}$	270	A
Surge current capability	I^2t		370	A ² s
Total power dissipation	P_{tot}	$T_j = T_{jmax}$ $T_s = 80\text{ °C}$	51	W
Maximum junction temperature	T_{jmax}		150	°C



Vincotech

Maximum Ratings

$T_j = 25\text{ °C}$, unless otherwise specified

Parameter	Symbol	Conditions	Value	Unit
Positive Boost Diode Protection Diode				
Peak repetitive reverse voltage	V_{RRM}		650	V
Forward current (DC current)	I_F	$T_j = T_{jmax}$ $T_s \leq 80\text{ °C}$	20 ⁽¹⁾	A
Repetitive peak forward current	I_{FRM}	t_p limited by T_{jmax}	20	A
Total power dissipation	P_{tot}	$T_j = T_{jmax}$ $T_s = 80\text{ °C}$	33	W
Maximum junction temperature	T_{jmax}		175	°C

⁽¹⁾ limited by I_{FRM}

Positive Boost Blocking Diode

Peak repetitive reverse voltage	V_{RRM}		1600	V
Forward current (DC current)	I_F	$T_j = T_{jmax}$ $T_s = 80\text{ °C}$	44	A
Surge (non-repetitive) forward current	I_{FSM}	Single Half Sine Wave, $t_p = 10\text{ ms}$ $T_j = 150\text{ °C}$	270	A
Surge current capability	I^2t		370	A ² s
Total power dissipation	P_{tot}	$T_j = T_{jmax}$ $T_s = 80\text{ °C}$	51	W
Maximum junction temperature	T_{jmax}		150	°C

Capacitor (DC)

Maximum DC voltage	V_{MAX}		500	V
Operation Temperature	T_{op}		-55 ... 125	°C

Module Properties

Thermal Properties

Storage temperature	T_{stg}		-40...+125	°C
Operation temperature under switching condition	T_{jop}		-40...+($T_{jmax} - 25$)	°C

Isolation Properties

Isolation voltage	V_{isol}	DC Test Voltage* $t_p = 2\text{ s}$	6000	V
Isolation voltage	V_{isol}	AC Voltage $t_p = 1\text{ min}$	2500	V
Creepage distance			>12,7	mm
Clearance			8,58	mm
Comparative Tracking Index	CTI		≥ 200	

*100 % tested in production



Vincotech

Characteristic Values

Parameter	Symbol	Conditions					Values			Unit
		V_{GE} [V] V_{GS} [V]	V_{CE} [V] V_{DS} [V] V_F [V]	I_C [A] I_D [A] I_F [A]	T_j [°C]	Min	Typ	Max		

Negative Neutral Point Switch

Static

Gate-emitter threshold voltage	$V_{GE(th)}$		5	0,033	25	5	6	7	V
Collector-emitter saturation voltage	$V_{CE(sat)}$	15		50	25 125 150		1,5 1,66 1,7	1,9 ⁽²⁾	V
Collector-emitter cut-off current	I_{CES}	0	650		25			0,01	mA
Gate-emitter leakage current	I_{GES}	30	0		25			0,2	μA
Internal gate resistance	r_g						None		Ω
Input capacitance	C_{ies}						4200		pF
Output capacitance	C_{oes}	$f = 1$ Mhz	0	30	25		104		pF
Reverse transfer capacitance	C_{res}						79		pF
Gate charge	Q_g		15	400	50	25	141		nC

Thermal

Thermal resistance junction to sink ⁽³⁾	$R_{th(j-s)}$	$\lambda_{paste} = 3,4$ W/mK (PSX)					1,23		K/W
--	---------------	---------------------------------------	--	--	--	--	------	--	-----

Dynamic

Turn-on delay time	$t_{d(on)}$					25 125 150		27,84 25,6 24,96	ns
Rise time	t_r	$R_{gon} = 8$ Ω $R_{goff} = 8$ Ω				25 125 150		14,4 15,04 15,36	ns
Turn-off delay time	$t_{d(off)}$		0/15	400	45	25 125 150		157,76 178,88 184,96	ns
Fall time	t_f					25 125 150		24,91 37,38 42,58	ns
Turn-on energy (per pulse)	E_{on}	$Q_{tFWD} = 0,07$ μC $Q_{tFWD} = 0,07$ μC $Q_{tFWD} = 0,07$ μC				25 125 150		0,302 0,359 0,351	mWs
Turn-off energy (per pulse)	E_{off}					25 125 150		0,779 1,08 1,13	mWs



Vincotech

Characteristic Values

Parameter	Symbol	Conditions					Values			Unit
		V_{GS} [V]	V_{GE} [V]	V_{DS} [V]	I_D [A]	T_j [°C]	Min	Typ	Max	

Positive Neutral Point Switch

Static

Gate-emitter threshold voltage	$V_{GE(th)}$		5	0,033	25	5	6	7	V
Collector-emitter saturation voltage	$V_{CE(sat)}$	15		50	25 125 150		1,5 1,66 1,7	1,9 ⁽²⁾	V
Collector-emitter cut-off current	I_{CES}	0	650		25			0,01	mA
Gate-emitter leakage current	I_{GES}	30	0		25			0,2	μA
Internal gate resistance	r_g						None		Ω
Input capacitance	C_{ies}						4200		pF
Output capacitance	C_{oes}	$f = 1$ Mhz	0	30	25		104		pF
Reverse transfer capacitance	C_{res}						79		pF
Gate charge	Q_g		15	400	50	25		141	nC

Thermal

Thermal resistance junction to sink ⁽³⁾	$R_{th(j-s)}$	$\lambda_{paste} = 3,4$ W/mK (PSX)						1,23	K/W
--	---------------	------------------------------------	--	--	--	--	--	------	-----

Dynamic

Turn-on delay time	$t_{d(on)}$					25 125 150		27,8 25 24,3	ns
Rise time	t_r	$R_{gon} = 8$ Ω $R_{goff} = 8$ Ω				25 125 150		15 16 16,3	ns
Turn-off delay time	$t_{d(off)}$		0/15	400	45	25 125 150		128 151 162	ns
Fall time	t_f					25 125 150		41,9 58,4 62,1	ns
Turn-on energy (per pulse)	E_{on}	$Q_{tFWD} = 0,117$ μC $Q_{tFWD} = 0,108$ μC $Q_{tFWD} = 0,107$ μC				25 125 150		0,24 0,259 0,263	mWs
Turn-off energy (per pulse)	E_{off}					25 125 150		1,15 1,68 1,81	mWs



Vincotech

10-PY073AA050RG02-LK14L03Y
datasheet

Characteristic Values

Parameter	Symbol	Conditions					Values			Unit
		V_{GE} [V] V_{GS} [V]	V_{CE} [V] V_{DS} [V] V_F [V]	I_C [A] I_D [A] I_F [A]	T_j [°C]	Min	Typ	Max		
Negative Boost Diode										
Static										
Forward voltage	V_F				20	25 125 150		1,38 1,52 1,57	1,55 ⁽²⁾	V
Reverse leakage current	I_R	$V_r = 650$ V				25 150		4 60	400	μA
Thermal										
Thermal resistance junction to sink ⁽³⁾	$R_{th(j-s)}$	$\lambda_{paste} = 3,4$ W/mK (PSX)						1,67		K/W
Dynamic										
Peak recovery current	I_{RM}					25 125 150		10,43 10,32 10,29		A
Reverse recovery time	t_{rr}					25 125 150		7,46 7,72 7,6		ns
Recovered charge	Q_r	$di/dt=3352$ A/μs $di/dt=3160$ A/μs $di/dt=3117$ A/μs	0/15	400	45	25 125 150		0,07 0,07 0,07		μC
Reverse recovered energy	E_{rec}					25 125 150		0,017 0,017 0,017		mWs
Peak rate of fall of recovery current	$(di_r/dt)_{max}$					25 125 150		4239 3967 3896		A/μs



Vincotech

10-PY073AA050RG02-LK14L03Y
datasheet

Characteristic Values

Parameter	Symbol	Conditions					Values			Unit
		V_{GE} [V] V_{GS} [V]	V_{CE} [V] V_{DS} [V] V_F [V]	I_C [A] I_D [A] I_F [A]	T_j [°C]	Min	Typ	Max		
Positive Boost Diode										
Static										
Forward voltage	V_F				20	25 125 150		1,38 1,52 1,57	1,55 ⁽²⁾	V
Reverse leakage current	I_R	$V_r = 650$ V				25 150		4 60	400	μA
Thermal										
Thermal resistance junction to sink ⁽³⁾	$R_{th(j-s)}$	$\lambda_{paste} = 3,4$ W/mK (PSX)						1,67		K/W
Dynamic										
Peak recovery current	I_{RM}					25 125 150		15,09 14,31 14,36		A
Reverse recovery time	t_{rr}					25 125 150		9,92 9,97 9,88		ns
Recovered charge	Q_r	$di/dt=3260$ A/μs $di/dt=3250$ A/μs $di/dt=3700$ A/μs	0/15	400	45	25 125 150		0,117 0,108 0,107		μC
Reverse recovered energy	E_{rec}					25 125 150		0,028 0,023 0,022		mWs
Peak rate of fall of recovery current	$(di_r/dt)_{max}$					25 125 150		4300 3910 4060		A/μs



Vincotech

Characteristic Values

Parameter	Symbol	Conditions					Values			Unit
		V_{GE} [V] V_{GS} [V]	V_{CE} [V] V_{DS} [V] V_F [V]	I_C [A] I_D [A] I_F [A]	T_j [°C]	Min	Typ	Max		

Negative Neutral Point Diode

Static

Forward voltage	V_F				28	25 125 150		1,1 1,04 1,03	1,5 ⁽²⁾	V
Reverse leakage current	I_R	$V_r = 1600$ V				25 150			100 1000	μA

Thermal

Thermal resistance junction to sink ⁽³⁾	$R_{th(j-s)}$	$\lambda_{paste} = 3,4$ W/mK (PSX)						1,37		K/W
--	---------------	------------------------------------	--	--	--	--	--	------	--	-----

Positive Neutral Point Diode

Static

Forward voltage	V_F				28	25 125 150		1,1 1,04 1,03	1,5 ⁽²⁾	V
Reverse leakage current	I_R	$V_r = 1600$ V				25 150			100 1000	μA

Thermal

Thermal resistance junction to sink ⁽³⁾	$R_{th(j-s)}$	$\lambda_{paste} = 3,4$ W/mK (PSX)						1,37		K/W
--	---------------	------------------------------------	--	--	--	--	--	------	--	-----



Vincotech

Characteristic Values

Parameter	Symbol	Conditions					Values			Unit
		V_{GS} [V]	V_{GE} [V]	V_{DS} [V]	V_{CE} [V]	T_j [°C]	Min	Typ	Max	

Positive Boost Diode Protection Diode

Static

Forward voltage	V_F				10	25 125	1,23	1,67 1,56	1,87 ⁽²⁾	V
Reverse leakage current	I_R	$V_r = 650$ V				25			0,14	μA

Thermal

Thermal resistance junction to sink ⁽³⁾	$R_{th(j-s)}$	$\lambda_{paste} = 3,4$ W/mK (PSX)						2,87		K/W
--	---------------	------------------------------------	--	--	--	--	--	------	--	-----

Positive Boost Blocking Diode

Static

Forward voltage	V_F				28	25 125 150		1,1 1,04 1,03	1,5 ⁽²⁾	V
Reverse leakage current	I_R	$V_r = 1600$ V				25 150			100 1000	μA

Thermal

Thermal resistance junction to sink ⁽³⁾	$R_{th(j-s)}$	$\lambda_{paste} = 3,4$ W/mK (PSX)						1,37		K/W
--	---------------	------------------------------------	--	--	--	--	--	------	--	-----

Capacitor (DC)

Static

Capacitance	C	DC bias voltage = 0 V				25		150		nF
Tolerance							-10		10	%
Dissipation factor		$f = 1$ kHz				25		2,5		%



Vincotech

Characteristic Values

Parameter	Symbol	Conditions					Values			Unit
		V_{GS} [V]	V_{GE} [V]	V_{DS} [V]	V_{CE} [V]	T_j [°C]	Min	Typ	Max	

Thermistor

Static

Rated resistance	R					25		22		kΩ
Deviation of R100	$A_{R/R}$	$R_{100} = 1484 \Omega$				100	-5		5	%
Power dissipation	P					25		130		mW
Power dissipation constant	d					25		1,5		mW/K
B-value	$B_{(25/50)}$	Tol. $\pm 1 \%$						3962		K
B-value	$B_{(25/100)}$	Tol. $\pm 1 \%$						4000		K
Vincotech Thermistor Reference									I	

⁽²⁾ Value at chip level

⁽³⁾ Only valid with pre-applied Vincotech thermal interface material.



Negative Neutral Point Switch Characteristics

figure 1. IGBT

Typical output characteristics

$$I_c = f(V_{CE})$$

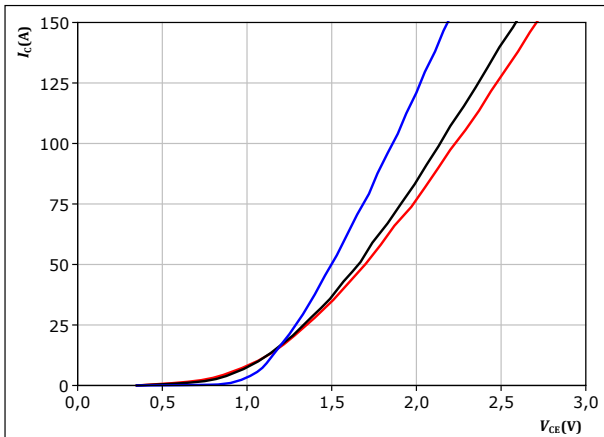

$t_p = 250 \mu\text{s}$
 $V_{GE} = 15 \text{ V}$

T_j : — 25 °C
— 125 °C
— 150 °C

figure 2. IGBT

Typical output characteristics

$$I_c = f(V_{CE})$$

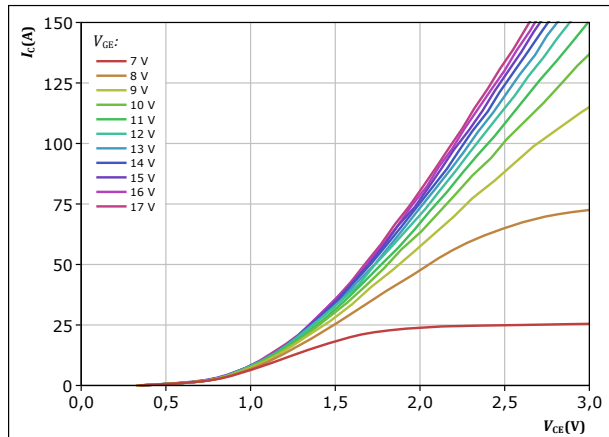

$t_p = 250 \mu\text{s}$
 $T_j = 150 \text{ °C}$
 V_{GE} from 7 V to 17 V in steps of 1 V

figure 3. IGBT

Typical transfer characteristics

$$I_c = f(V_{GE})$$

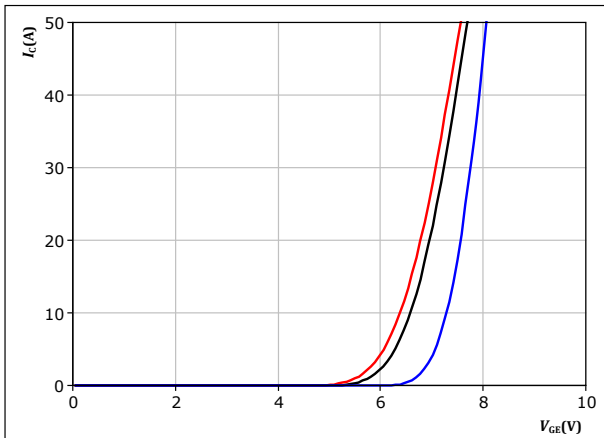

$t_p = 250 \mu\text{s}$
 $V_{CE} = 10 \text{ V}$

T_j : — 25 °C
— 125 °C
— 150 °C

figure 4. IGBT

Transient thermal impedance as a function of pulse width

$$Z_{th(j-s)} = f(t_p)$$

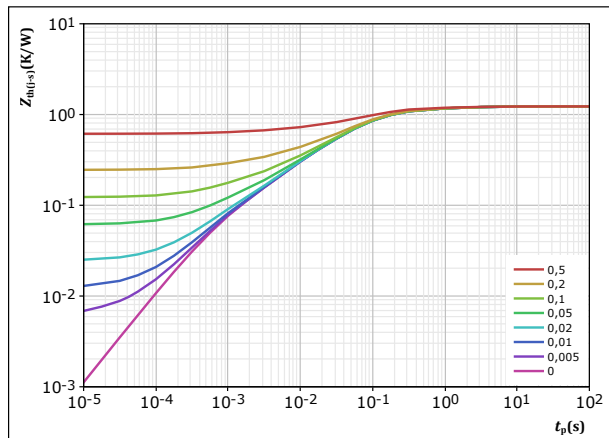

$D = t_p / T$
 $R_{th(j-s)} = 1,228 \text{ K/W}$

IGBT thermal model values

R (K/W)	τ (s)
5,07E-02	3,25E+00
1,43E-01	5,26E-01
5,97E-01	9,03E-02
2,58E-01	2,71E-02
1,27E-01	5,65E-03
5,33E-02	7,25E-04



Negative Neutral Point Switch Characteristics

figure 5. IGBT

Safe operating area

$$I_C = f(V_{CE})$$

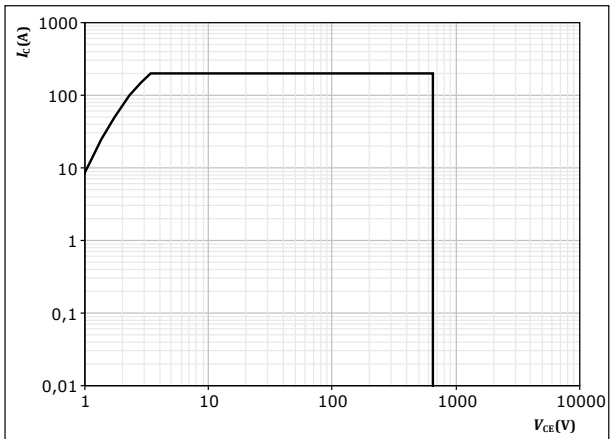

$D =$ single pulse

$T_s = 80$ °C

$V_{GE} = 15$ V

$T_j = T_{jmax}$



Positive Neutral Point Switch Characteristics

figure 6. IGBT

Typical output characteristics

$$I_c = f(V_{CE})$$

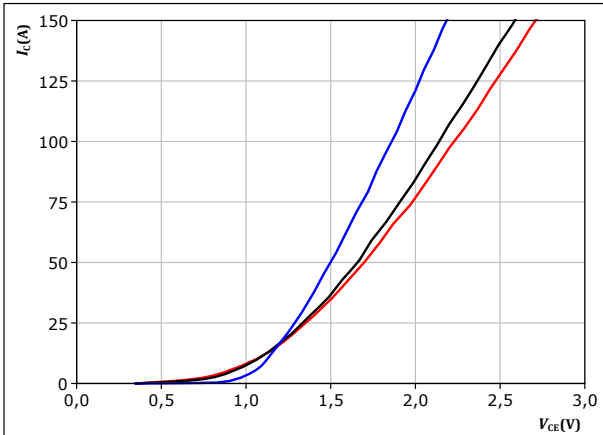

$t_p = 250\ \mu\text{s}$
 $V_{GE} = 15\ \text{V}$
 $T_j:$ — 25 °C
— 125 °C
— 150 °C

figure 7. IGBT

Typical output characteristics

$$I_c = f(V_{CE})$$

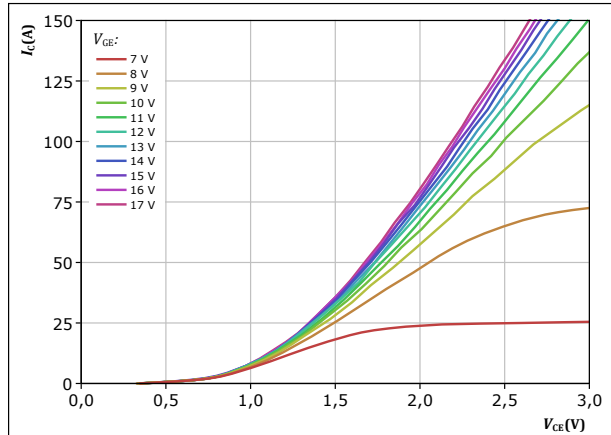

$t_p = 250\ \mu\text{s}$
 $T_j = 150\text{ °C}$
 V_{GE} from 7 V to 17 V in steps of 1 V

figure 8. IGBT

Typical transfer characteristics

$$I_c = f(V_{GE})$$

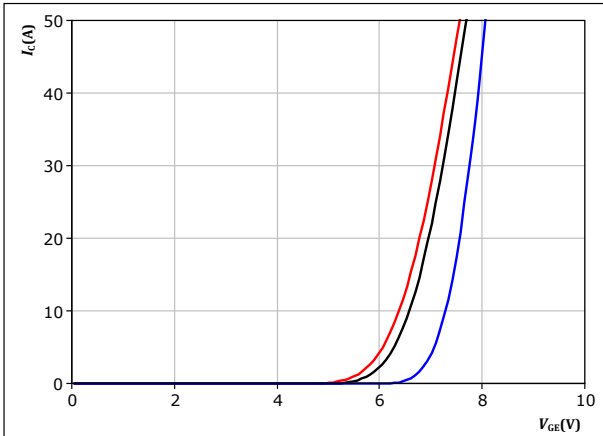

$t_p = 250\ \mu\text{s}$
 $V_{CE} = 10\ \text{V}$
 $T_j:$ — 25 °C
— 125 °C
— 150 °C

figure 9. IGBT

Transient thermal impedance as a function of pulse width

$$Z_{th(j-s)} = f(t_p)$$

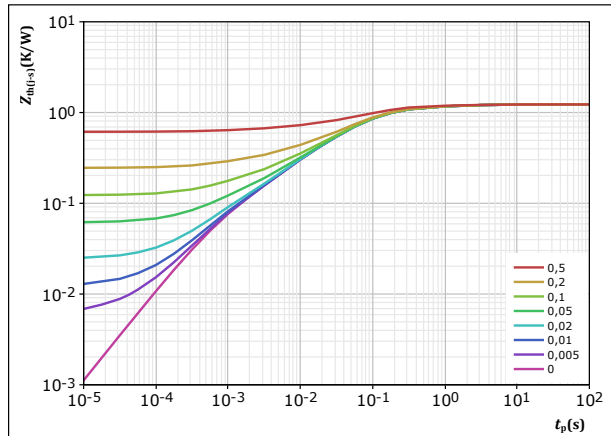

$D = t_p / T$
 $R_{th(j-s)} = 1,228\ \text{K/W}$
IGBT thermal model values

R (K/W)	τ (s)
5,07E-02	3,25E+00
1,43E-01	5,26E-01
5,97E-01	9,03E-02
2,58E-01	2,71E-02
1,27E-01	5,65E-03
5,33E-02	7,25E-04



Positive Neutral Point Switch Characteristics

figure 10. IGBT

Safe operating area

$$I_C = f(V_{CE})$$

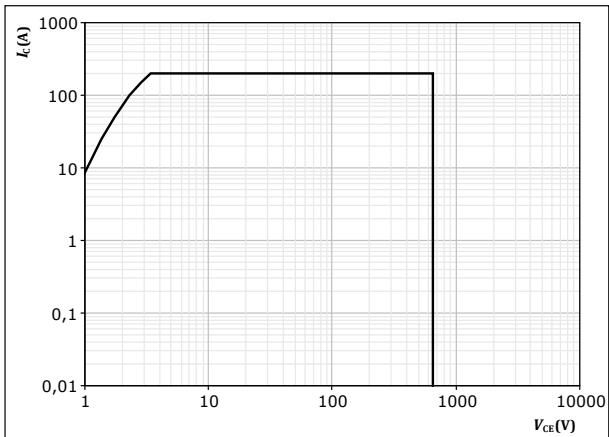

D = single pulse
T_s = 80 °C
V_{CE} = 15 V
T_j = T_{jmax}



Negative Boost Diode Characteristics

figure 11. FWD

Typical forward characteristics

$$I_F = f(V_F)$$

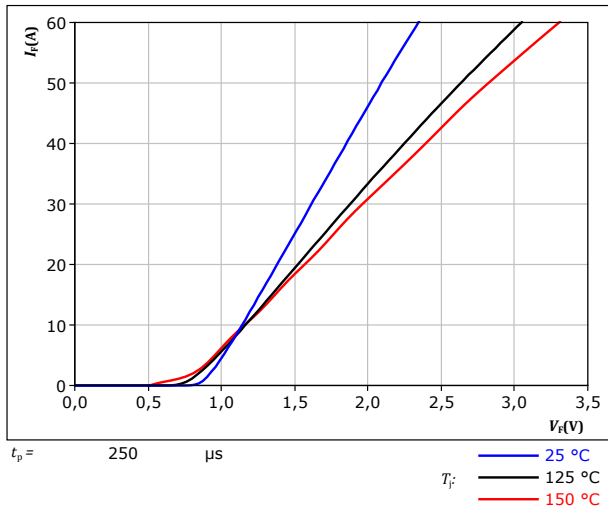
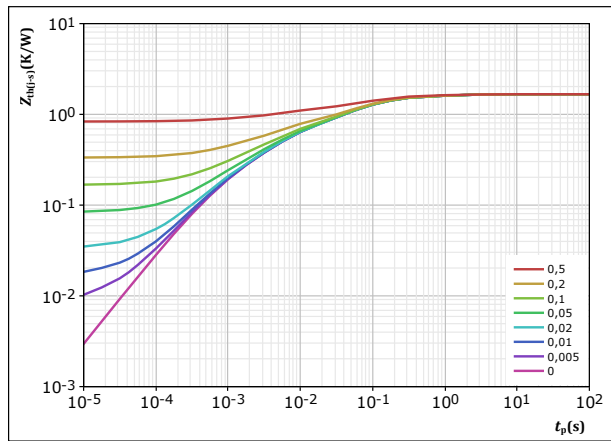

figure 12. FWD

Transient thermal impedance as a function of pulse width

$$Z_{th(j-s)} = f(t_p)$$



$D = t_p / T$
 $R_{th(j-s)} = 1,667$ K/W
 FWD thermal model values

R (K/W)	τ (s)
1,23E-01	1,39E+00
4,95E-01	1,34E-01
5,29E-01	3,82E-02
4,07E-01	4,31E-03
1,14E-01	6,14E-04



Positive Boost Diode Characteristics

figure 13. FWD

Typical forward characteristics

$$I_F = f(V_F)$$

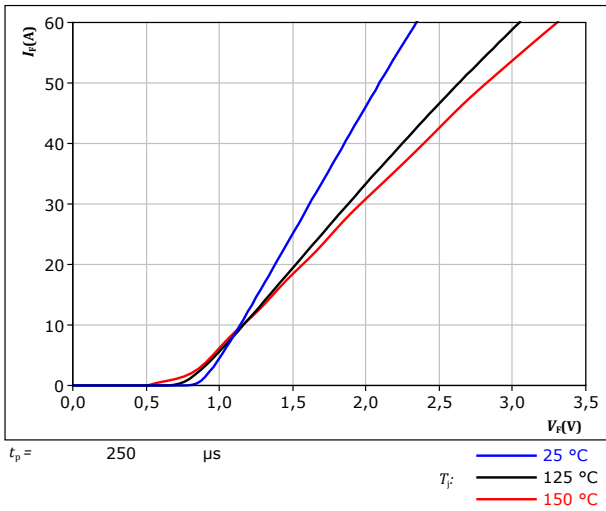
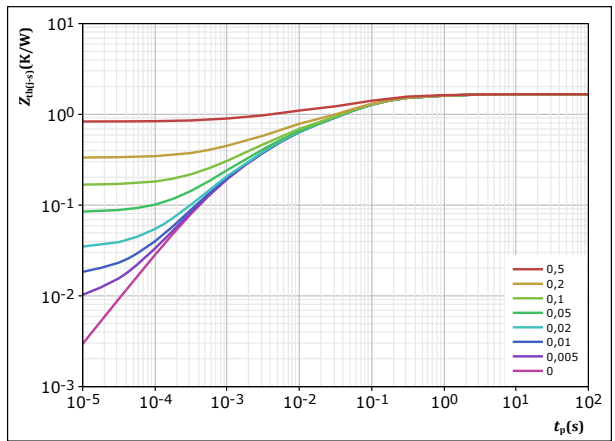

figure 14. FWD

Transient thermal impedance as a function of pulse width

$$Z_{th(j-s)} = f(t_p)$$



$D = t_p / T$
 $R_{th(j-s)} = 1,667 \text{ K/W}$
 FWD thermal model values

R (K/W)	τ (s)
1,23E-01	1,39E+00
4,95E-01	1,34E-01
5,29E-01	3,82E-02
4,07E-01	4,31E-03
1,14E-01	6,14E-04



Negative Neutral Point Diode Characteristics

figure 15. Rectifier

Typical forward characteristics

$$I_F = f(V_F)$$

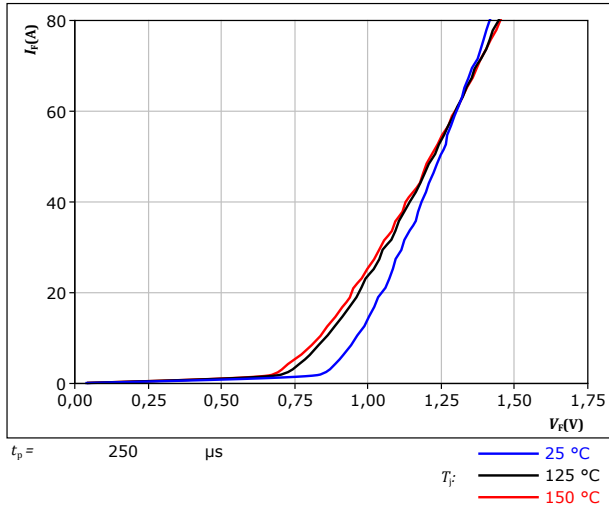
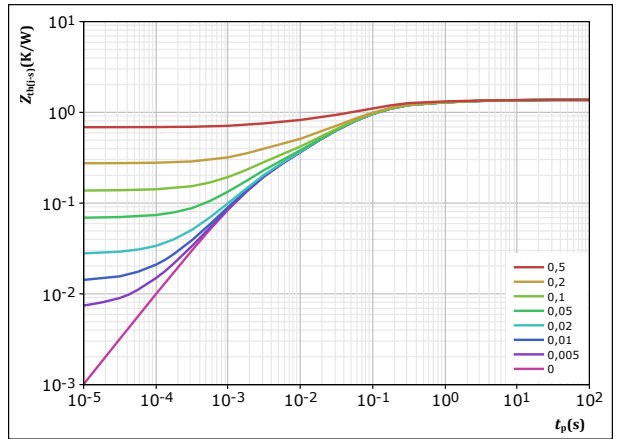

figure 16. Rectifier

Transient thermal impedance as a function of pulse width

$$Z_{th(j-s)} = f(t_p)$$



$D = t_p / T$
 $R_{th(j-s)} = 1,372$ K/W
 Rectifier thermal model values

R (K/W)	τ (s)
5,28E-02	6,37E+00
1,59E-01	6,68E-01
6,89E-01	8,84E-02
3,22E-01	1,74E-02
1,49E-01	2,00E-03



Positive Neutral Point Diode Characteristics

figure 17. Rectifier

Typical forward characteristics

$$I_F = f(V_F)$$

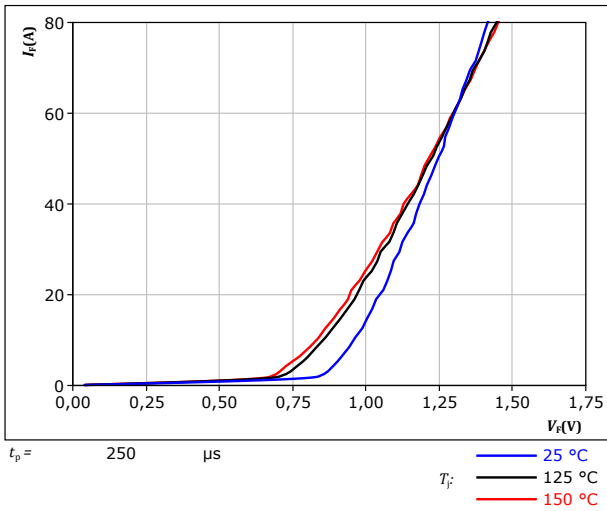
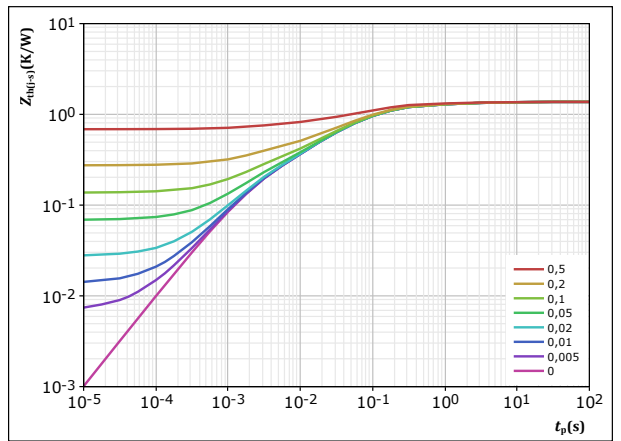

figure 18. Rectifier

Transient thermal impedance as a function of pulse width

$$Z_{th(j-s)} = f(t_p)$$



$D = t_p / T$
 $R_{th(j-s)} = 1,372 \text{ K/W}$
 Rectifier thermal model values

R (K/W)	τ (s)
5,28E-02	6,37E+00
1,59E-01	6,68E-01
6,89E-01	8,84E-02
3,22E-01	1,74E-02
1,49E-01	2,00E-03



Positive Boost Diode Protection Diode Characteristics

figure 19. FWD

Typical forward characteristics

$$I_F = f(V_F)$$

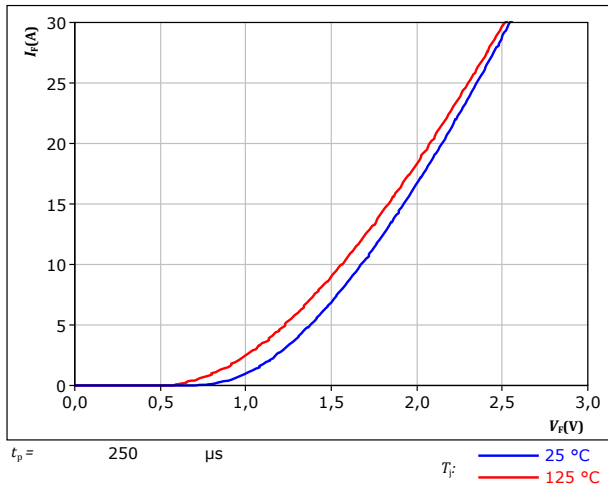
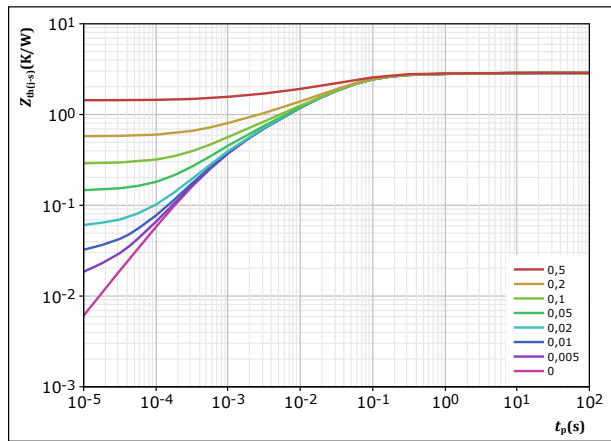

figure 20. FWD

Transient thermal impedance as a function of pulse width

$$Z_{th(j-s)} = f(t_p)$$



$D = t_p / T$
 $R_{th(j-s)} = 2,873 \text{ K/W}$
 FWD thermal model values

R (K/W)	τ (s)
6,53E-02	3,94E+00
1,48E-01	4,48E-01
1,31E+00	5,96E-02
7,32E-01	1,36E-02
4,04E-01	2,79E-03
2,11E-01	5,37E-04



Positive Boost Blocking Diode Characteristics

figure 21. Rectifier

Typical forward characteristics

$$I_F = f(V_F)$$

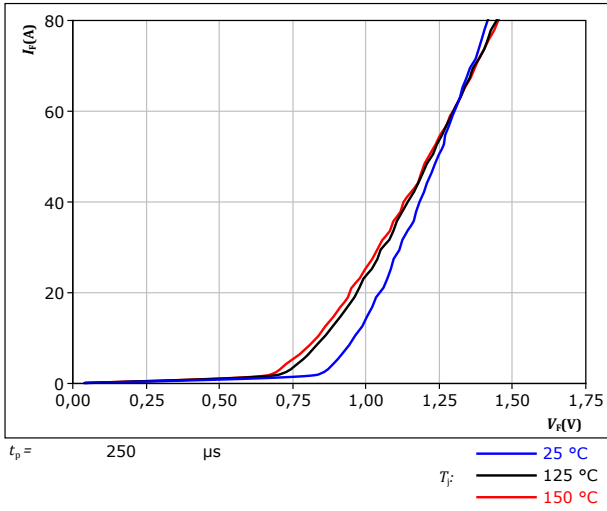
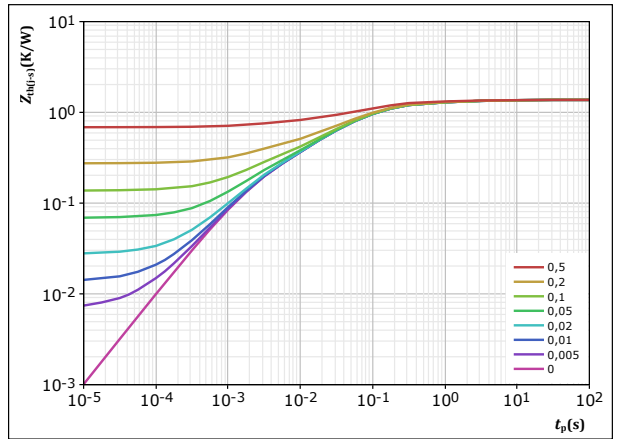

figure 22. Rectifier

Transient thermal impedance as a function of pulse width

$$Z_{th(j-s)} = f(t_p)$$



$D = t_p / T$

$R_{th(j-s)} = 1,372 \text{ K/W}$

Rectifier thermal model values

$R \text{ (K/W)}$	$\tau \text{ (s)}$
5,28E-02	6,37E+00
1,59E-01	6,68E-01
6,89E-01	8,84E-02
3,22E-01	1,74E-02
1,49E-01	2,00E-03



Thermistor Characteristics

figure 23. Thermistor

Typical NTC characteristic as function of temperature

$$R_T = f(T)$$

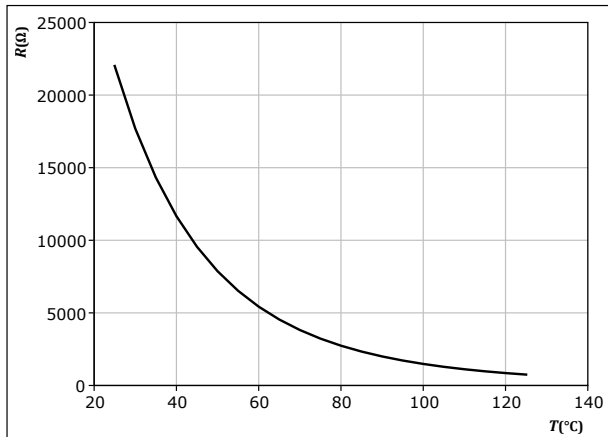



Negative Neutral Point Switching Characteristics

figure 24. IGBT

Typical switching energy losses as a function of collector current
 $E = f(I_c)$

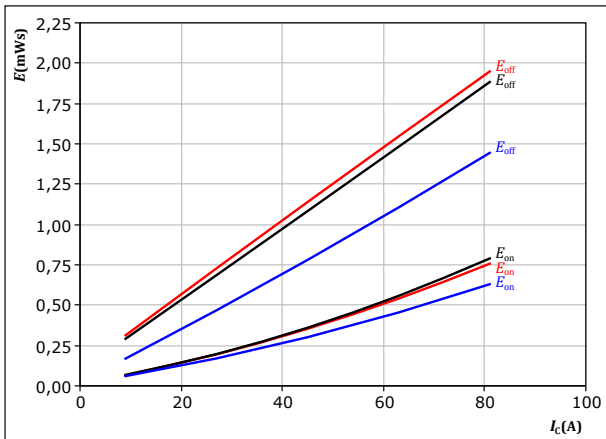

With an inductive load at

$V_{CE} = 400$ V
 $V_{GE} = 0/15$ V
 $R_{gon} = 8$ Ω
 $R_{goff} = 8$ Ω

T_j : — 25 °C
 — 125 °C
 — 150 °C

figure 25. IGBT

Typical switching energy losses as a function of IGBT turn on gate resistor
 $E = f(R_g)$

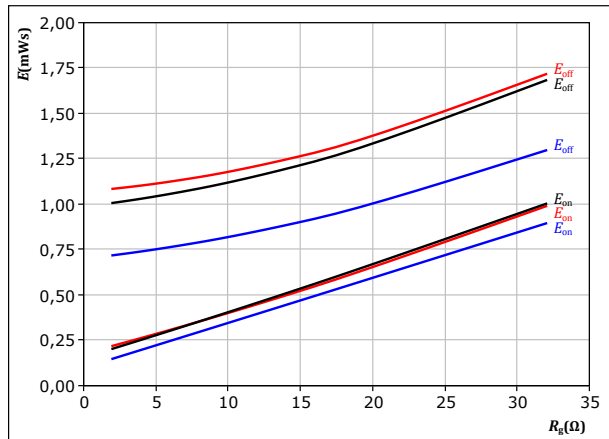

With an inductive load at

$V_{CE} = 400$ V
 $V_{GE} = 0/15$ V
 $I_c = 45$ A

T_j : — 25 °C
 — 125 °C
 — 150 °C

figure 26. FWD

Typical reverse recovered energy loss as a function of collector current
 $E_{rec} = f(I_c)$

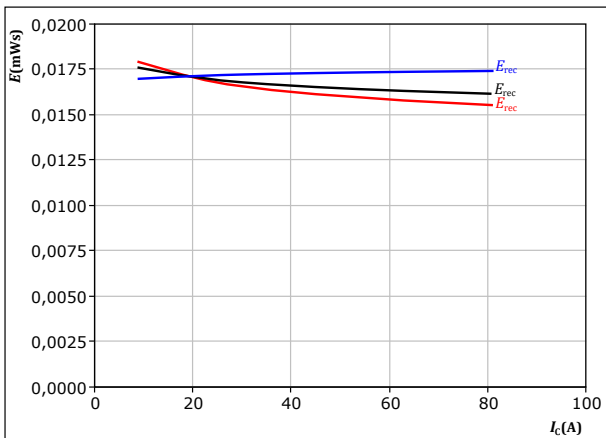

With an inductive load at

$V_{CE} = 400$ V
 $V_{GE} = 0/15$ V
 $R_{gon} = 8$ Ω

T_j : — 25 °C
 — 125 °C
 — 150 °C

figure 27. FWD

Typical reverse recovered energy loss as a function of IGBT turn on gate resistor
 $E_{rec} = f(R_g)$

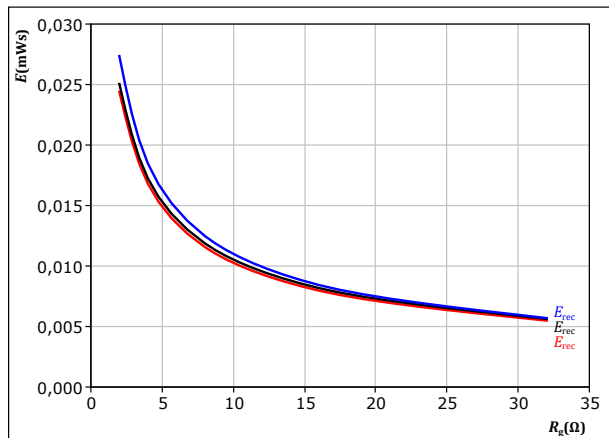

With an inductive load at

$V_{CE} = 400$ V
 $V_{GE} = 0/15$ V
 $I_c = 45$ A

T_j : — 25 °C
 — 125 °C
 — 150 °C



Negative Neutral Point Switching Characteristics

figure 28. IGBT

Typical switching times as a function of collector current
 $t = f(I_c)$

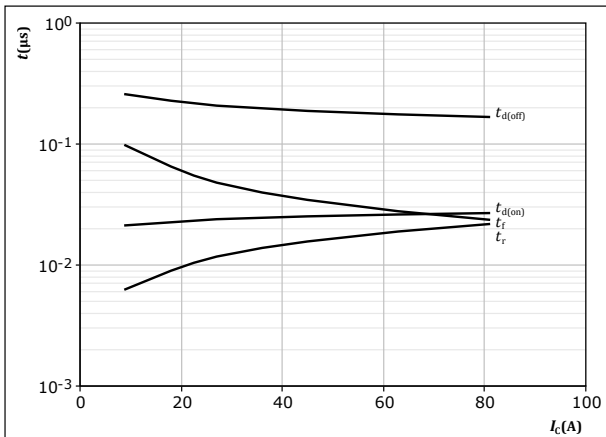

With an inductive load at
 $T_j = 150 \text{ }^\circ\text{C}$
 $V_{CE} = 400 \text{ V}$
 $V_{GE} = 0/15 \text{ V}$
 $R_{gon} = 8 \text{ } \Omega$
 $R_{goff} = 8 \text{ } \Omega$

figure 29. IGBT

Typical switching times as a function of IGBT turn on gate resistor
 $t = f(R_g)$

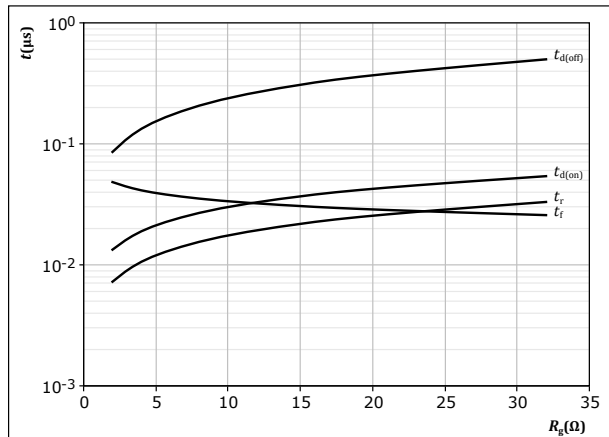

With an inductive load at
 $T_j = 150 \text{ }^\circ\text{C}$
 $V_{CE} = 400 \text{ V}$
 $V_{GE} = 0/15 \text{ V}$
 $I_c = 45 \text{ A}$

figure 30. FWD

Typical reverse recovery time as a function of collector current
 $t_{rr} = f(I_c)$

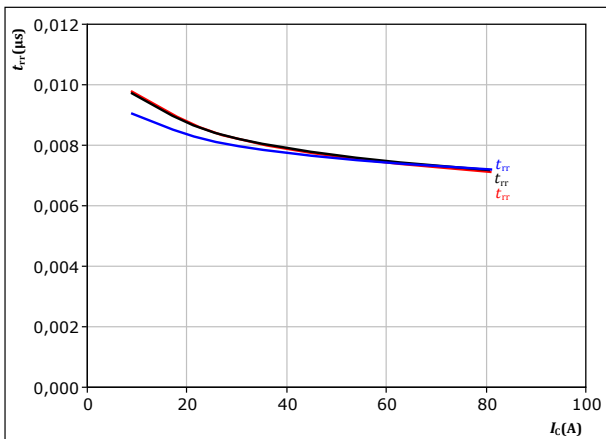

With an inductive load at
 $V_{CE} = 400 \text{ V}$
 $V_{GE} = 0/15 \text{ V}$
 $R_{gon} = 8 \text{ } \Omega$
 $T_j: \text{ — } 25 \text{ }^\circ\text{C}$
 $\text{ — } 125 \text{ }^\circ\text{C}$
 $\text{ — } 150 \text{ }^\circ\text{C}$

figure 31. FWD

Typical reverse recovery time as a function of IGBT turn on gate resistor
 $t_{rr} = f(R_{gon})$

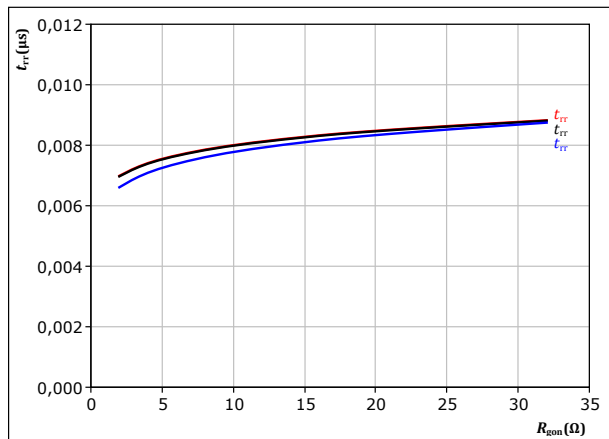

With an inductive load at
 $V_{CE} = 400 \text{ V}$
 $V_{GE} = 0/15 \text{ V}$
 $I_c = 45 \text{ A}$
 $T_j: \text{ — } 25 \text{ }^\circ\text{C}$
 $\text{ — } 125 \text{ }^\circ\text{C}$
 $\text{ — } 150 \text{ }^\circ\text{C}$



Negative Neutral Point Switching Characteristics

figure 32. FWD

Typical recovered charge as a function of collector current

$$Q_r = f(I_c)$$

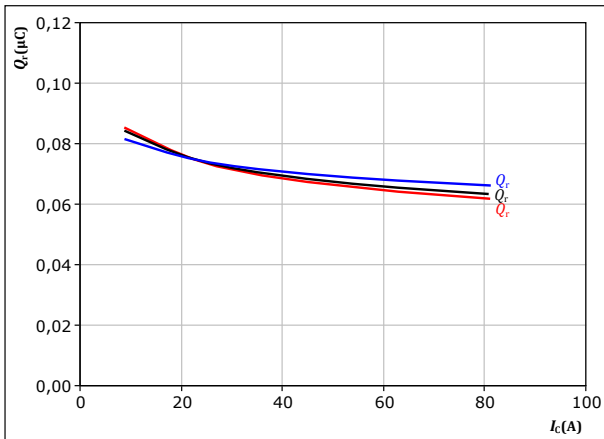

With an inductive load at

$V_{CE} = 400 \text{ V}$
 $V_{GE} = 0/15 \text{ V}$
 $R_{gon} = 8 \ \Omega$

T_j : — 25 °C
— 125 °C
— 150 °C

figure 33. FWD

Typical recovered charge as a function of IGBT turn on gate resistor

$$Q_r = f(R_{gon})$$

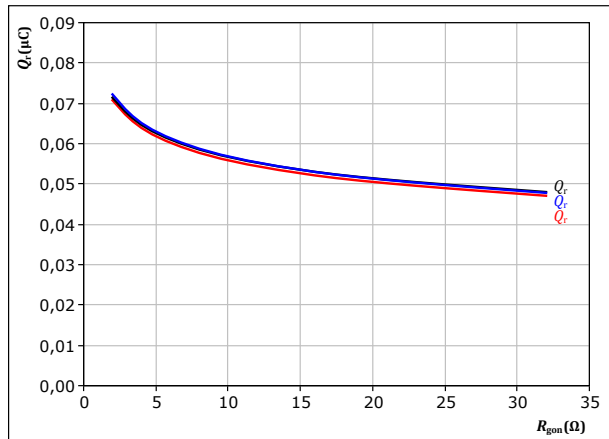

With an inductive load at

$V_{CE} = 400 \text{ V}$
 $V_{GE} = 0/15 \text{ V}$
 $I_c = 45 \text{ A}$

T_j : — 25 °C
— 125 °C
— 150 °C

figure 34. FWD

Typical peak reverse recovery current as a function of collector current

$$I_{RM} = f(I_c)$$

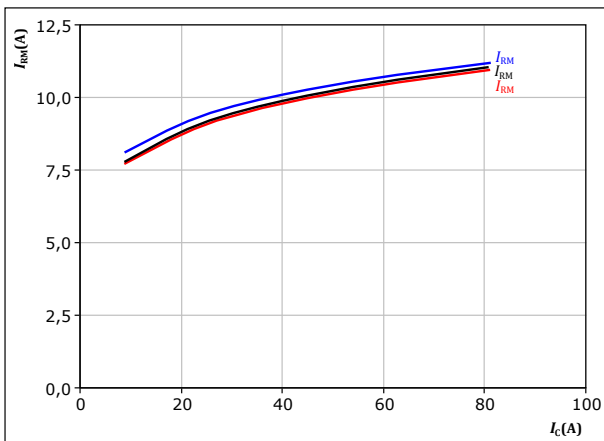

With an inductive load at

$V_{CE} = 400 \text{ V}$
 $V_{GE} = 0/15 \text{ V}$
 $R_{gon} = 8 \ \Omega$

T_j : — 25 °C
— 125 °C
— 150 °C

figure 35. FWD

Typical peak reverse recovery current as a function of IGBT turn on gate resistor

$$I_{RM} = f(R_{gon})$$

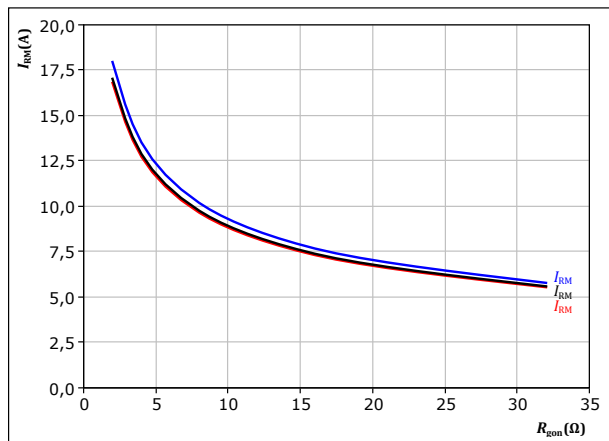

With an inductive load at

$V_{CE} = 400 \text{ V}$
 $V_{GE} = 0/15 \text{ V}$
 $I_c = 45 \text{ A}$

T_j : — 25 °C
— 125 °C
— 150 °C



Negative Neutral Point Switching Characteristics

figure 36. FWD

Typical rate of fall of forward and reverse recovery current as a function of collector current
 $di_f/dt, di_{rr}/dt = f(I_c)$

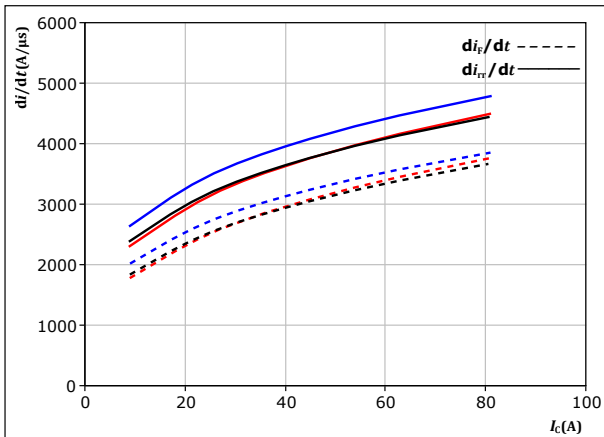

With an inductive load at

$V_{CE} = 400$ V
 $V_{GE} = 0/15$ V
 $R_{gon} = 8$ Ω

T_j : — 25 °C
 — 125 °C
 — 150 °C

figure 37. FWD

Typical rate of fall of forward and reverse recovery current as a function of turn on gate resistor
 $di_f/dt, di_{rr}/dt = f(R_{gon})$

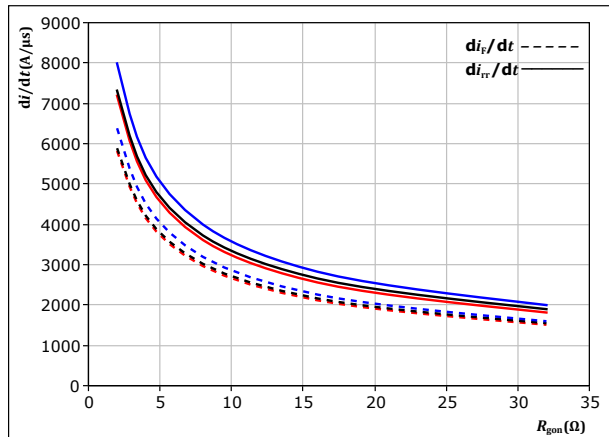

With an inductive load at

$V_{CE} = 400$ V
 $V_{GE} = 0/15$ V
 $I_c = 45$ A

T_j : — 25 °C
 — 125 °C
 — 150 °C

figure 38. IGBT

Reverse bias safe operating area

$I_c = f(V_{CE})$

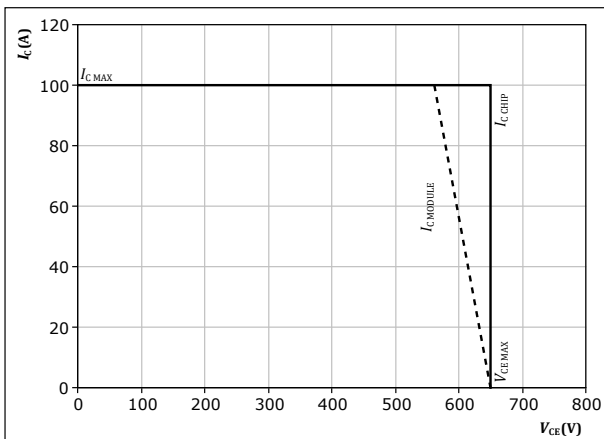

At $T_j = 150$ °C
 $R_{gon} = 8$ Ω
 $R_{goff} = 8$ Ω



Positive Neutral Point Switching Characteristics

figure 39. IGBT

Typical switching energy losses as a function of collector current
 $E = f(I_c)$

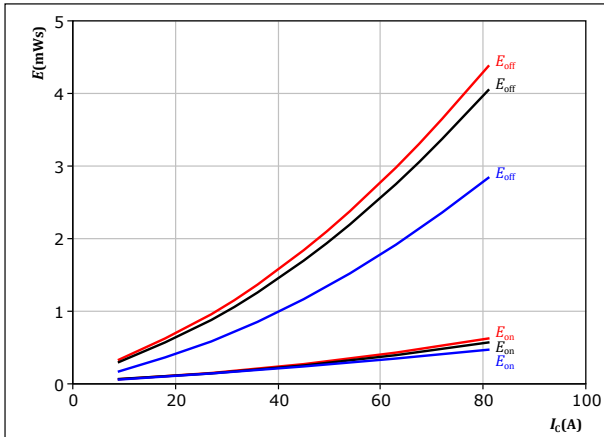

With an inductive load at

$V_{CE} = 400 \text{ V}$
 $V_{GE} = 0/15 \text{ V}$
 $R_{gon} = 8 \ \Omega$
 $R_{goff} = 8 \ \Omega$

T_j : — 25 °C
— 125 °C
— 150 °C

figure 40. IGBT

Typical switching energy losses as a function of IGBT turn on gate resistor
 $E = f(R_g)$

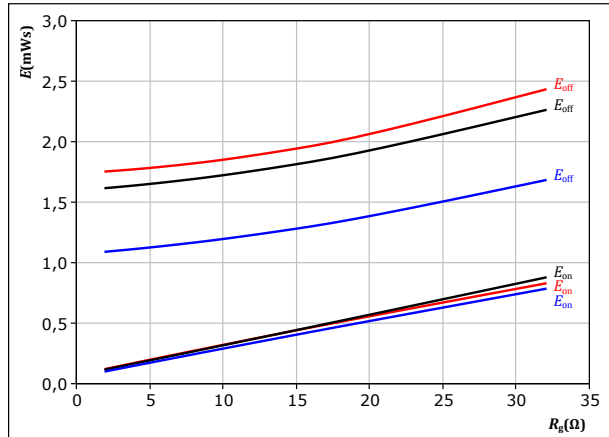

With an inductive load at

$V_{CE} = 400 \text{ V}$
 $V_{GE} = 0/15 \text{ V}$
 $I_c = 45 \text{ A}$

T_j : — 25 °C
— 125 °C
— 150 °C

figure 41. FWD

Typical reverse recovered energy loss as a function of collector current
 $E_{rec} = f(I_c)$

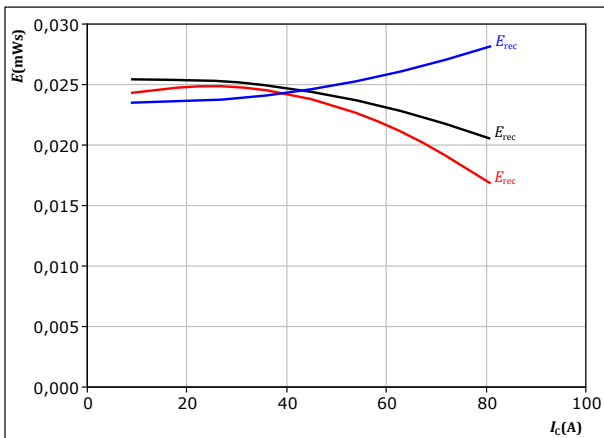

With an inductive load at

$V_{CE} = 400 \text{ V}$
 $V_{GE} = 0/15 \text{ V}$
 $R_{gon} = 8 \ \Omega$

T_j : — 25 °C
— 125 °C
— 150 °C

figure 42. FWD

Typical reverse recovered energy loss as a function of IGBT turn on gate resistor
 $E_{rec} = f(R_g)$

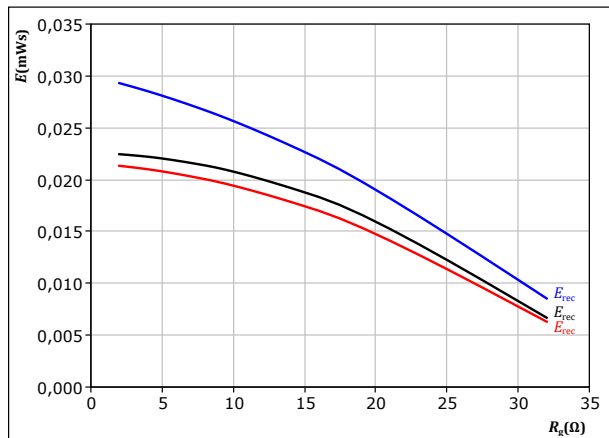

With an inductive load at

$V_{CE} = 400 \text{ V}$
 $V_{GE} = 0/15 \text{ V}$
 $I_c = 45 \text{ A}$

T_j : — 25 °C
— 125 °C
— 150 °C



Positive Neutral Point Switching Characteristics

figure 43. IGBT

Typical switching times as a function of collector current
 $t = f(I_c)$

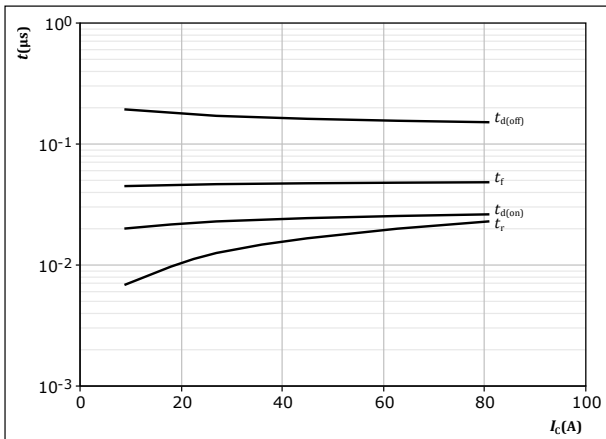

With an inductive load at
 $T_j = 150 \text{ }^\circ\text{C}$
 $V_{CE} = 400 \text{ V}$
 $V_{GE} = 0/15 \text{ V}$
 $R_{gon} = 8 \text{ } \Omega$
 $R_{goff} = 8 \text{ } \Omega$

figure 44. IGBT

Typical switching times as a function of IGBT turn on gate resistor
 $t = f(R_g)$

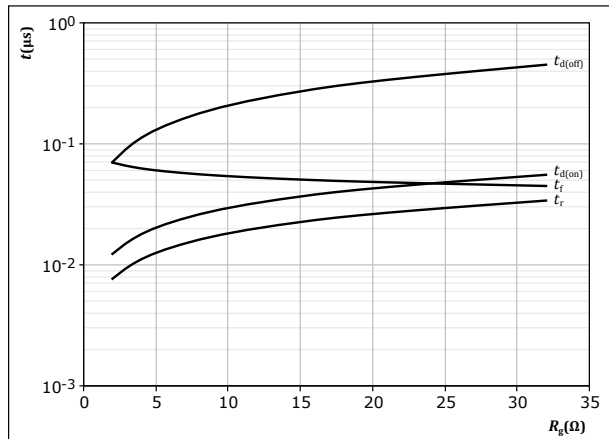

With an inductive load at
 $T_j = 150 \text{ }^\circ\text{C}$
 $V_{CE} = 400 \text{ V}$
 $V_{GE} = 0/15 \text{ V}$
 $I_c = 45 \text{ A}$

figure 45. FWD

Typical reverse recovery time as a function of collector current
 $t_{rr} = f(I_c)$

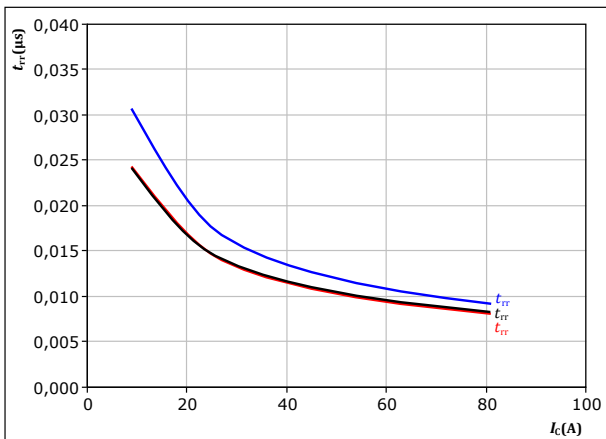

With an inductive load at
 $V_{CE} = 400 \text{ V}$
 $V_{GE} = 0/15 \text{ V}$
 $R_{gon} = 8 \text{ } \Omega$
 $T_j:$ — 25 $^\circ\text{C}$
 — 125 $^\circ\text{C}$
 — 150 $^\circ\text{C}$

figure 46. FWD

Typical reverse recovery time as a function of IGBT turn on gate resistor
 $t_{rr} = f(R_{gon})$

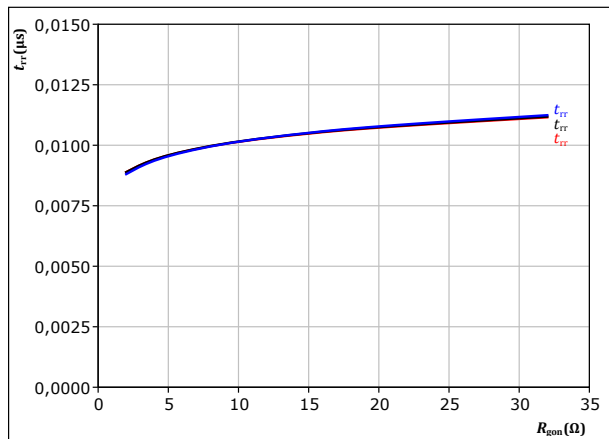

With an inductive load at
 $V_{CE} = 400 \text{ V}$
 $V_{GE} = 0/15 \text{ V}$
 $I_c = 45 \text{ A}$
 $T_j:$ — 25 $^\circ\text{C}$
 — 125 $^\circ\text{C}$
 — 150 $^\circ\text{C}$



Positive Neutral Point Switching Characteristics

figure 47. FWD

Typical recovered charge as a function of collector current

$$Q_r = f(I_c)$$

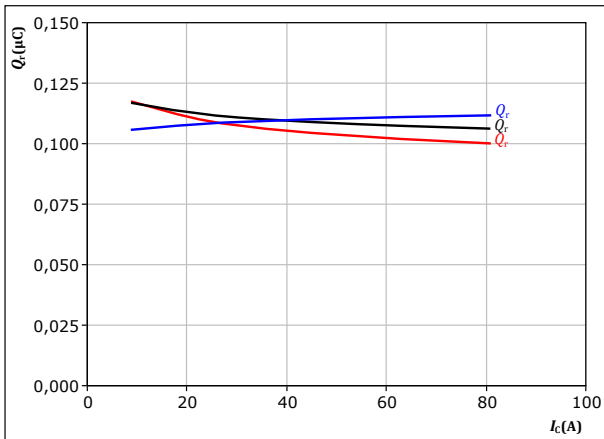

With an inductive load at

$V_{CE} = 400$ V
 $V_{GE} = 0/15$ V
 $R_{gon} = 8$ Ω

T_j : — 25 °C
— 125 °C
— 150 °C

figure 48. FWD

Typical recovered charge as a function of IGBT turn on gate resistor

$$Q_r = f(R_{gon})$$

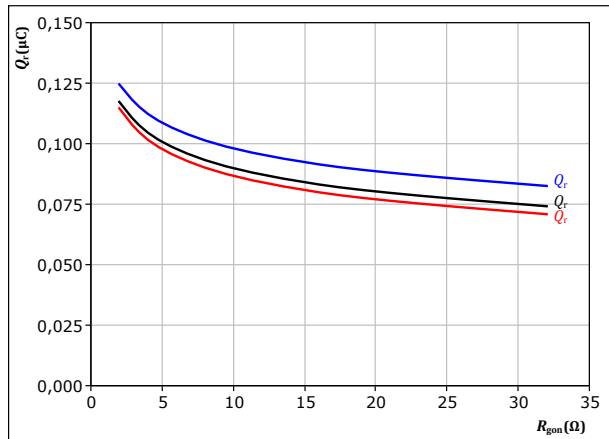

With an inductive load at

$V_{CE} = 400$ V
 $V_{GE} = 0/15$ V
 $I_c = 45$ A

T_j : — 25 °C
— 125 °C
— 150 °C

figure 49. FWD

Typical peak reverse recovery current as a function of collector current

$$I_{RM} = f(I_c)$$

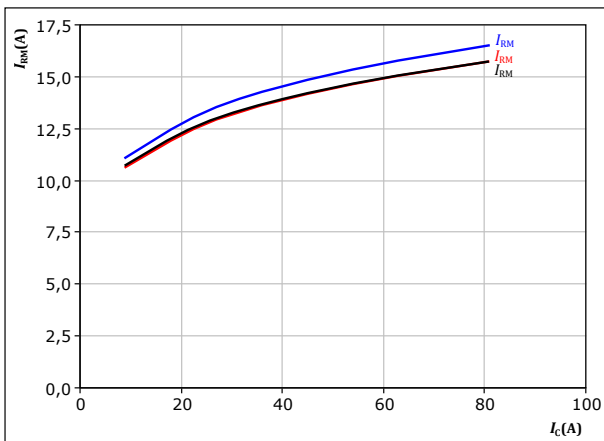

With an inductive load at

$V_{CE} = 400$ V
 $V_{GE} = 0/15$ V
 $R_{gon} = 8$ Ω

T_j : — 25 °C
— 125 °C
— 150 °C

figure 50. FWD

Typical peak reverse recovery current as a function of IGBT turn on gate resistor

$$I_{RM} = f(R_{gon})$$

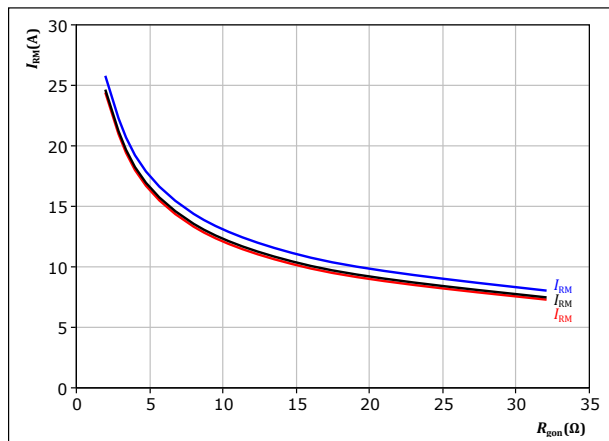

With an inductive load at

$V_{CE} = 400$ V
 $V_{GE} = 0/15$ V
 $I_c = 45$ A

T_j : — 25 °C
— 125 °C
— 150 °C



Positive Neutral Point Switching Characteristics

figure 51. FWD

Typical rate of fall of forward and reverse recovery current as a function of collector current
 $di_f/dt, di_r/dt = f(I_C)$

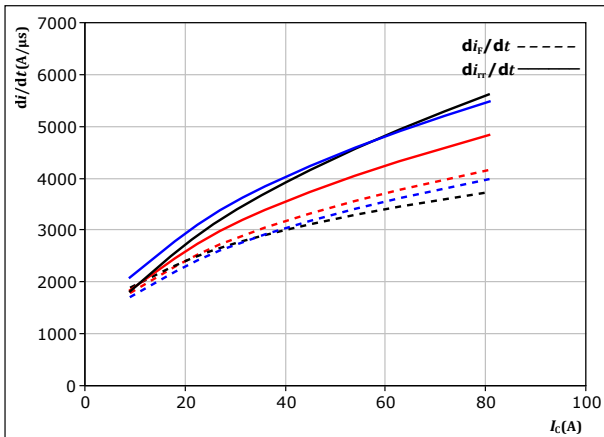

With an inductive load at

$V_{CE} = 400$ V
 $V_{GE} = 0/15$ V
 $R_{gon} = 8$ Ω

T_j :
— 25 °C
— 125 °C
— 150 °C

figure 52. FWD

Typical rate of fall of forward and reverse recovery current as a function of turn on gate resistor
 $di_f/dt, di_r/dt = f(R_{gon})$

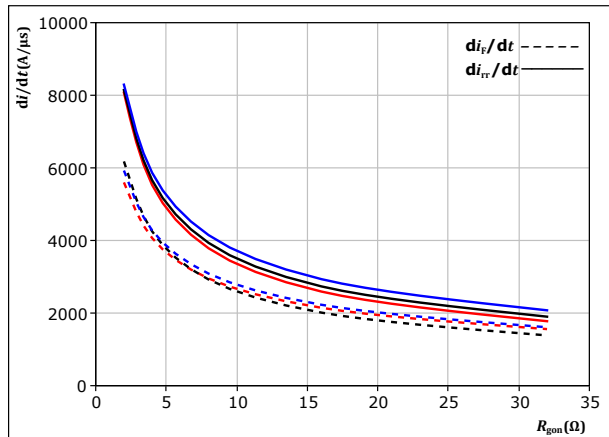

With an inductive load at

$V_{CE} = 400$ V
 $V_{GE} = 0/15$ V
 $I_C = 45$ A

T_j :
— 25 °C
— 125 °C
— 150 °C

figure 53. IGBT

Reverse bias safe operating area

$I_C = f(V_{CE})$

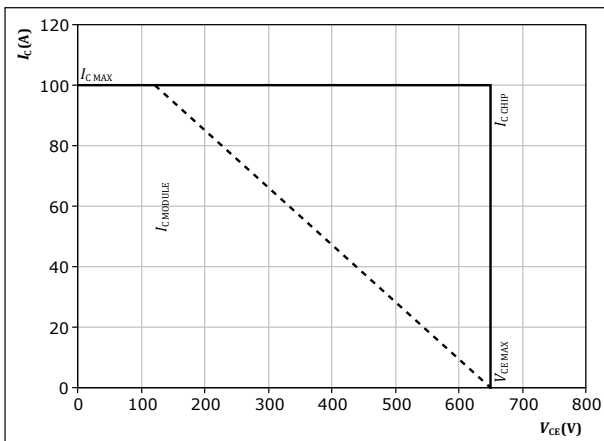

At $T_j = 150$ °C
 $R_{gon} = 8$ Ω
 $R_{goff} = 8$ Ω



Switching Definitions

figure 54. IGBT

Turn-off Switching Waveforms & definition of t_{doff} , t_{Eoff} (t_{Eoff} = integrating time for E_{off})

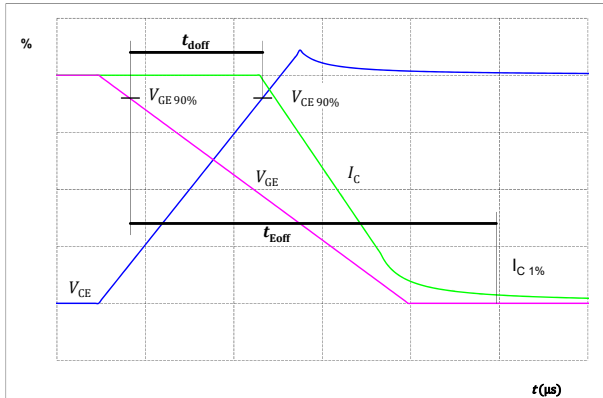

figure 55. IGBT

Turn-on Switching Waveforms & definition of t_{don} , t_{Eon} (t_{Eon} = integrating time for E_{on})

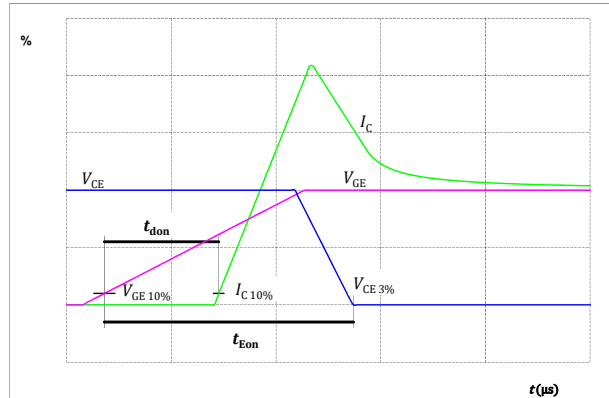

figure 56. IGBT

Turn-off Switching Waveforms & definition of t_f

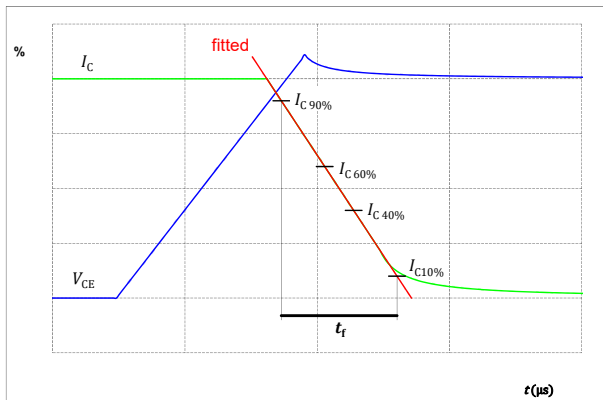
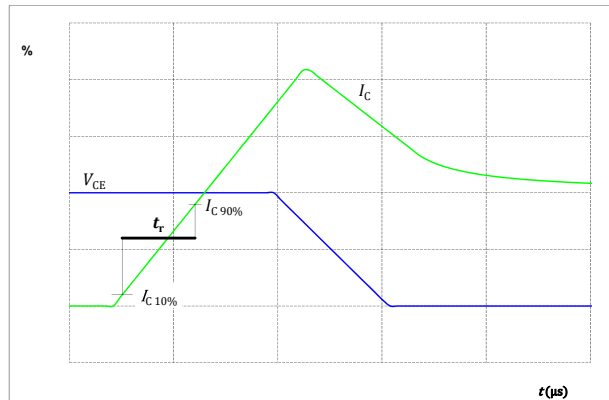

figure 57. IGBT

Turn-on Switching Waveforms & definition of t_r





Switching Definitions

figure 58. FWD

Turn-off Switching Waveforms & definition of t_{rr}

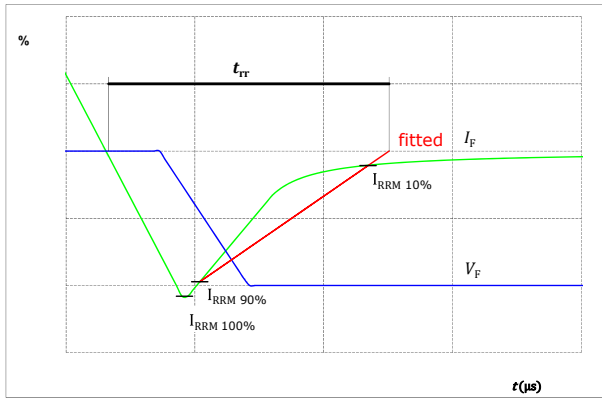
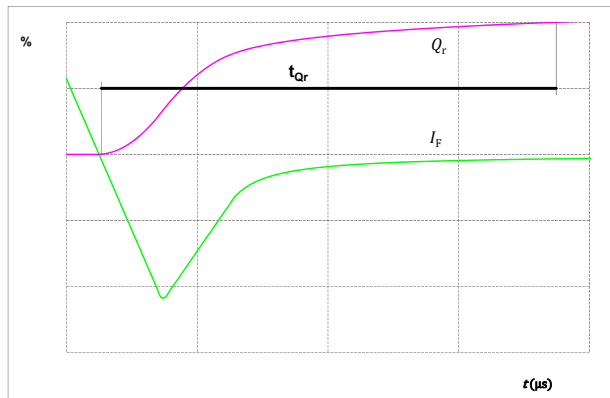

figure 59. FWD

Turn-on Switching Waveforms & definition of t_{Qr} (t_{Qr} = integrating time for Q_r)





Vincotech

10-PY073AA050RG02-LK14L03Y

datasheet

Ordering Code	
Version	Ordering Code
Without thermal paste	10-PY073AA050RG02-LK14L03Y
With thermal paste (5,2 W/mK, PTM6000HV)	10-PY073AA050RG02-LK14L03Y-/-7/
With thermal paste (3,4 W/mK, PSX-P7)	10-PY073AA050RG02-LK14L03Y-/-3/

Marking						
	Text	Name NN-NNNNNNNNNNNNNN- TTTTIV	Date code WWYY	UL & VIN UL VIN	Lot LLLLL	Serial SSSS
	Datamatrix	Type&Ver TTTTIV	Lot number LLLLL	Serial SSSS	Date code WWYY	

Pin table [mm]			
Pin	X	Y	Function
1	52,9	0	TM61
2	42,35	0	Ph3
3	34,25	0	TM51
4	23,7	0	Ph2
5	15,7	0	TM41
6	7,9	0	Ph1
7	0	0	Therm1
8	0	3	Therm2
9	2	15,65	DC-1
10	6,35	28,9	G14
11	9,35	28,9	G13
12	7,85	25,9	S1
13	24,9	28,9	G24
14	27,9	28,9	G23
15	26,4	25,9	S2
16	43,55	28,9	G34
17	46,55	28,9	G33
18	45,05	25,9	S3
19	52,75	9,35	DC+3
20	45,4	11,4	GND3
21	39,2	15,65	DC-3
22	34,1	9,35	DC+2
23	26,75	11,4	GND2
24	20,55	15,65	DC-2
25	15,55	9,35	DC+1
26	8,2	11,4	GND1



Pinout

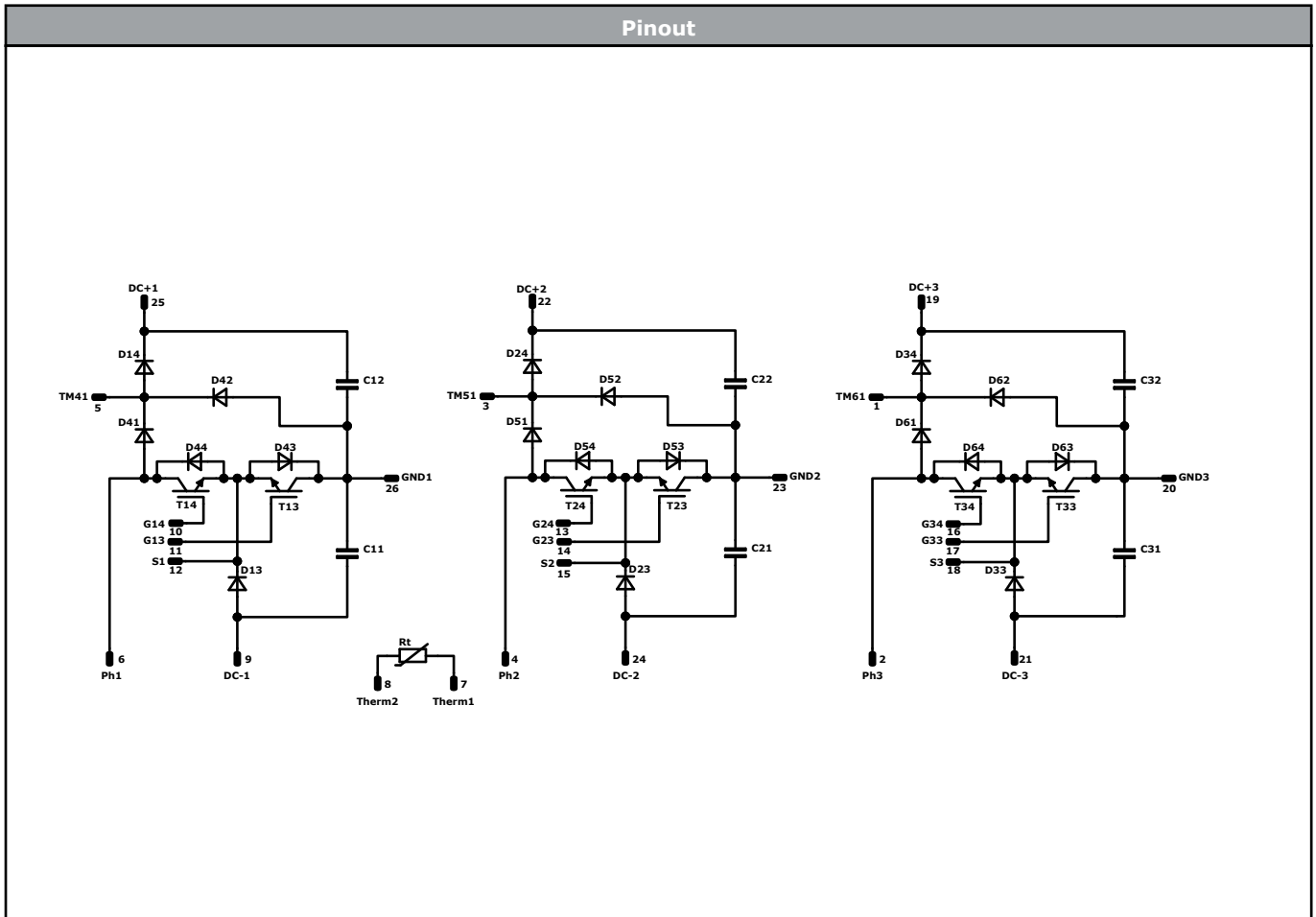

Identification

ID	Component	Voltage	Current	Function	Comment
T13, T23, T33	IGBT	650 V	50 A	Negative Neutral Point Switch	
T14, T24, T34	IGBT	650 V	50 A	Positive Neutral Point Switch	
D13, D23, D33	FWD	650 V	20 A	Negative Boost Diode	
D14, D24, D34	FWD	650 V	20 A	Positive Boost Diode	
D43, D53, D63	Rectifier	1600 V	28 A	Negative Neutral Point Diode	
D44, D54, D64	Rectifier	1600 V	28 A	Positive Neutral Point Diode	
D42, D52, D62	FWD	650 V	10 A	Positive Boost Diode Protection Diode	
D41, D51, D61	Rectifier	1600 V	28 A	Positive Boost Blocking Diode	
C11, C12, C21, C22, C31, C32	Capacitor	500 V		Capacitor (DC)	
Rt	Thermistor			Thermistor	



Vincotech

Packaging instruction				
Standard packaging quantity (SPQ) 100	>SPQ	Standard	<SPQ	Sample

Handling instruction
Handling instructions for <i>flow 1</i> packages see vincotech.com website.

Package data
Package data for <i>flow 1</i> packages see vincotech.com website.

Vincotech thermistor reference
See Vincotech thermistor reference table at vincotech.com website.

UL recognition and file number
This device is certified according to UL 1557 standard, UL file number E192116. For more information see vincotech.com website. 

Document No.:	Date:	Modification:	Pages
10-PY073AA050RG02-LK14L03Y-D2-14	14 Sep. 2023	PCN-39-2023 Alternative supplier for rectifier diodes	

DISCLAIMER

The information, specifications, procedures, methods and recommendations herein (together "information") are presented by Vincotech to reader in good faith, are believed to be accurate and reliable, but may well be incomplete and/or not applicable to all conditions or situations that may exist or occur. Vincotech reserves the right to make any changes without further notice to any products to improve reliability, function or design. No representation, guarantee or warranty is made to reader as to the accuracy, reliability or completeness of said information or that the application or use of any of the same will avoid hazards, accidents, losses, damages or injury of any kind to persons or property or that the same will not infringe third parties rights or give desired results. It is reader's sole responsibility to test and determine the suitability of the information and the product for reader's intended use.

LIFE SUPPORT POLICY

Vincotech products are not authorised for use as critical components in life support devices or systems without the express written approval of Vincotech.

As used herein:

1. Life support devices or systems are devices or systems which, (a) are intended for surgical implant into the body, or (b) support or sustain life, or (c) whose failure to perform when properly used in accordance with instructions for use provided in labelling can be reasonably expected to result in significant injury to the user.
2. A critical component is any component of a life support device or system whose failure to perform can be reasonably expected to cause the failure of the life support device or system, or to affect its safety or effectiveness.