



flowPIM 0 + PFC

650 V / 20 A

Topology features

- Converter+PFC+Inverter
- Integrated Shunt Resistor
- Open Emitter configuration
- Temperature sensor

Component features

- Easy paralleling
- Low collector emitter saturation voltage
- Low turn-off losses
- Positive temperature coefficient

Housing features

- Base isolation: Al₂O₃
- Convex shaped substrate for superior thermal contact
- Thermo-mechanical push-and-pull force relief
- Solder pin

Target applications

Embedded Drives; Heat Pumps; HVAC; Industrial Drives

Types

- 10-FU07PPA020I7-M685B56

flow 0 12 mm housing

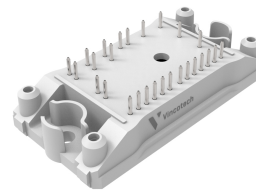

Schematic

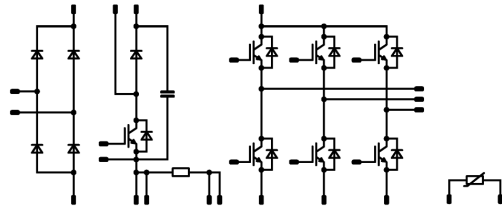



Vincotech

10-FU07PPA020I7-M685B56
datasheet

Maximum Ratings

$T_j = 25\text{ °C}$, unless otherwise specified

Parameter	Symbol	Conditions	Value	Unit
Inverter Switch				
Collector-emitter voltage	V_{CES}		650	V
Collector current (DC current)	I_C	$T_j = T_{jmax}$ $T_s = 80\text{ °C}$	32	A
Repetitive peak collector current	I_{CRM}	t_p limited by T_{jmax}	60	A
Total power dissipation	P_{tot}	$T_j = T_{jmax}$ $T_s = 80\text{ °C}$	58	W
Gate-emitter voltage	V_{GES}		± 20	V
Short circuit ratings	i_{SC}	$V_{GE} = 15\text{ V}$, $V_{CC} = 400\text{ V}$ $T_j = 150\text{ °C}$	3	μs
Maximum junction temperature	T_{jmax}		175	$^{\circ}\text{C}$

Inverter Diode

Peak repetitive reverse voltage	V_{RRM}		650	V
Forward current (DC current)	I_F	$T_j = T_{jmax}$ $T_s = 80\text{ °C}$	27	A
Repetitive peak forward current	I_{FRM}	t_p limited by T_{jmax}	60	A
Total power dissipation	P_{tot}	$T_j = T_{jmax}$ $T_s = 80\text{ °C}$	46	W
Maximum junction temperature	T_{jmax}		175	$^{\circ}\text{C}$

PFC Sw. Inverse Diode

Peak repetitive reverse voltage	V_{RRM}		650	V
Forward current (DC current)	I_F	$T_j = T_{jmax}$ $T_s = 80\text{ °C}$	27	A
Repetitive peak forward current	I_{FRM}	t_p limited by T_{jmax}	60	A
Total power dissipation	P_{tot}	$T_j = T_{jmax}$ $T_s = 80\text{ °C}$	46	W
Maximum junction temperature	T_{jmax}		175	$^{\circ}\text{C}$



Vincotech

Maximum Ratings

$T_j = 25\text{ °C}$, unless otherwise specified

Parameter	Symbol	Conditions	Value	Unit
PFC Switch				
Collector-emitter voltage	V_{CES}		650	V
Collector current (DC current)	I_C	$T_j = T_{jmax}$ $T_s = 80\text{ °C}$	41	A
Repetitive peak collector current	I_{CRM}	t_p limited by T_{jmax}	120	A
Total power dissipation	P_{tot}	$T_j = T_{jmax}$ $T_s = 80\text{ °C}$	73	W
Gate-emitter voltage	V_{GES}		± 20	V
Maximum junction temperature	T_{jmax}		175	°C
PFC Diode				
Peak repetitive reverse voltage	V_{RRM}		600	V
Forward current (DC current)	I_F	$T_j = T_{jmax}$ $T_s = 80\text{ °C}$	55	A
Repetitive peak forward current	I_{FRM}	t_p limited by T_{jmax}	120	A
Surge (non-repetitive) forward current	I_{FSM}	Single Half Sine Wave, $t_p = 10\text{ ms}$ $T_j = 25\text{ °C}$	480	A
Total power dissipation	P_{tot}	$T_j = T_{jmax}$ $T_s = 80\text{ °C}$	76	W
Maximum junction temperature	T_{jmax}		175	°C
Rectifier Diode				
Peak repetitive reverse voltage	V_{RRM}		1600	V
Forward current (DC current)	I_F	$T_j = T_{jmax}$ $T_s = 80\text{ °C}$	43	A
Surge (non-repetitive) forward current	I_{FSM}	Single Half Sine Wave, $t_p = 10\text{ ms}$ $T_j = 150\text{ °C}$	270	A
Surge current capability	I^2t		370	A ² s
Total power dissipation	P_{tot}	$T_j = T_{jmax}$ $T_s = 80\text{ °C}$	50	W
Maximum junction temperature	T_{jmax}		150	°C



Vincotech

10-FU07PPA020I7-M685B56
datasheet

Maximum Ratings

$T_j = 25\text{ °C}$, unless otherwise specified

Parameter	Symbol	Conditions	Value	Unit
PFC Shunt				
DC current	I		27,1	A
Power dissipation	P_{tot}	$T_c = 70\text{ °C}$	5	W
Operation Temperature	T_{op}		-55 ... 170	°C

Capacitor (PFC)

Maximum DC voltage	V_{MAX}		630	V
Operation Temperature	T_{op}		-55 ... 150	°C

Module Properties

Thermal Properties

Storage temperature	T_{stg}		-40...+125	°C
Operation temperature under switching condition	T_{jop}		$-40...+(T_{jmax} - 25)$	°C

Isolation Properties

Isolation voltage	V_{isol}	DC Test Voltage* $t_p = 2\text{ s}$	6000	V
Creepage distance			>12,7	mm
Clearance			8,75	mm
Comparative Tracking Index	CTI		≥ 200	

*100 % tested in production



Vincotech

Characteristic Values

Parameter	Symbol	Conditions					Values			Unit
		V_{GS} [V]	V_{GE} [V]	V_{DS} [V]	I_D [A]	T_j [°C]	Min	Typ	Max	

Inverter Switch

Static

Gate-emitter threshold voltage	$V_{GE(th)}$	$V_{CE} = V_{GE}$			0,0002	25	4,35	5	5,65	V
Collector-emitter saturation voltage	$V_{CE(sat)}$		15		20	25 125 150		1,32 1,4 1,43	1,65 ⁽¹⁾	V
Collector-emitter cut-off current	I_{CES}		0	650		25			20	μA
Gate-emitter leakage current	I_{GES}		20	0		25			100	nA
Internal gate resistance	r_g							None		Ω
Input capacitance	C_{ies}							1310		pF
Output capacitance	C_{oes}	$f = 1$ Mhz	0	25		25		42		pF
Reverse transfer capacitance	C_{res}							13		pF
Gate charge	Q_g	$V_{CC} = 520$ V	15		20	25		128		nC

Thermal

Thermal resistance junction to sink ⁽²⁾	$R_{th(j-s)}$	$\lambda_{paste} = 3,4$ W/mK (PSX)						1,63		K/W
--	---------------	------------------------------------	--	--	--	--	--	------	--	-----

Dynamic

Turn-on delay time	$t_{d(on)}$					25 125 150		90,25 92,76 93,01		ns
Rise time	t_r	$R_{gon} = 16$ Ω $R_{goff} = 16$ Ω				25 125 150		34,26 34,9 35,11		ns
Turn-off delay time	$t_{d(off)}$		±15	350	30	25 125 150		119,21 141,31 146,12		ns
Fall time	t_f					25 125 150		28,94 49,18 54,13		ns
Turn-on energy (per pulse)	E_{on}	$Q_{tFWD} = 0,518$ μC $Q_{tFWD} = 1,14$ μC $Q_{tFWD} = 1,33$ μC				25 125 150		0,654 0,868 0,916		mWs
Turn-off energy (per pulse)	E_{off}					25 125 150		0,459 0,666 0,717		mWs



Vincotech

10-FU07PPA020I7-M685B56
datasheet

Characteristic Values

Parameter	Symbol	Conditions						Values			Unit
		V_{GE} [V] V_{GS} [V]	V_{CE} [V] V_{DS} [V] V_F [V]	I_C [A] I_D [A] I_F [A]	T_j [°C]	Min	Typ	Max			
Inverter Diode											
Static											
Forward voltage	V_F				20	25 125 150		1,71 1,6 1,55	2 ⁽¹⁾	V	
Reverse leakage current	I_R	$V_r = 650$ V				25			20	μA	
Thermal											
Thermal resistance junction to sink ⁽²⁾	$R_{th(j-s)}$	$\lambda_{paste} = 3,4$ W/mK (PSX)						2,05		K/W	
Dynamic											
Peak recovery current	I_{RM}					25 125 150		8,35 12,89 13,96		A	
Reverse recovery time	t_{rr}					25 125 150		102,6 146,71 162,67		ns	
Recovered charge	Q_r	$di/dt=664$ A/μs $di/dt=630$ A/μs $di/dt=654$ A/μs	±15	350	30	25 125 150		0,518 1,14 1,33		μC	
Reverse recovered energy	E_{rec}					25 125 150		0,11 0,253 0,299		mWs	
Peak rate of fall of recovery current	$(di_r/dt)_{max}$					25 125 150		296,19 173,24 141,25		A/μs	



Vincotech

10-FU07PPA020I7-M685B56
datasheet

Characteristic Values

Parameter	Symbol	Conditions					Values			Unit
		V_{GE} [V] V_{GS} [V]	V_{CE} [V] V_{DS} [V] V_F [V]	I_C [A] I_D [A] I_F [A]	T_j [°C]	Min	Typ	Max		

PFC Sw. Inverse Diode

Static

Forward voltage	V_F				20	25 125 150		1,71 1,6 1,55	2 ⁽¹⁾	V
Reverse leakage current	I_R	$V_r = 650$ V				25			20	μA

Thermal

Thermal resistance junction to sink ⁽²⁾	$R_{th(j-s)}$	$\lambda_{paste} = 3,4$ W/mK (PSX)						2,05		K/W
--	---------------	---------------------------------------	--	--	--	--	--	------	--	-----



Vincotech

10-FU07PPA020I7-M685B56
datasheet

Characteristic Values

Parameter	Symbol	Conditions					Values			Unit
		V_{GS} [V]	V_{GE} [V]	V_{DS} [V]	I_D [A]	T_j [°C]	Min	Typ	Max	

PFC Switch

Static

Gate-emitter threshold voltage	$V_{GE(th)}$	$V_{CE} = V_{GE}$			0,0004	25	3,3	4	4,7	V
Collector-emitter saturation voltage	$V_{CE(sat)}$		15		40	25 125 150		1,54 1,69 1,74	2,22 ⁽¹⁾	V
Collector-emitter cut-off current	I_{CES}		0	650		25			80	μA
Gate-emitter leakage current	I_{GES}		20	0		25			240	nA
Internal gate resistance	r_g							None		Ω
Input capacitance	C_{ies}							2400		pF
Output capacitance	C_{oes}	$f = 1$ Mhz	0	25		25		60		pF
Reverse transfer capacitance	C_{res}							10		pF
Gate charge	Q_g	$V_{CC} = 520$ V	15		40	25		96		nC

Thermal

Thermal resistance junction to sink ⁽²⁾	$R_{th(j-s)}$	$\lambda_{paste} = 3,4$ W/mK (PSX)						1,3		K/W
--	---------------	---------------------------------------	--	--	--	--	--	-----	--	-----

Dynamic

Turn-on delay time	$t_{d(on)}$					25 125 150		12,61 12,28 12,02		ns
Rise time	t_r					25 125 150		4,28 5,95 6,6		ns
Turn-off delay time	$t_{d(off)}$					25 125 150		65,93 78,86 82,24		ns
Fall time	t_f					25 125 150		4,11 11,67 13,52		ns
Turn-on energy (per pulse)	E_{on}	$Q_{tFWD} = 1,1$ μC $Q_{tFWD} = 2,52$ μC $Q_{tFWD} = 3,07$ μC				25 125 150		0,494 0,845 0,957		mWs
Turn-off energy (per pulse)	E_{off}					25 125 150		0,224 0,375 0,42		mWs



Vincotech

10-FU07PPA020I7-M685B56
datasheet

Characteristic Values

Parameter	Symbol	Conditions					Values			Unit
		V_{GE} [V] V_{GS} [V]	V_{CE} [V] V_{DS} [V] V_F [V]	I_C [A] I_D [A] I_F [A]	T_j [°C]	Min	Typ	Max		
PFC Diode										
Static										
Forward voltage	V_F				60	25 125 150		1,89 1,57 1,5	2,5 ⁽¹⁾	V
Reverse leakage current	I_R	$V_r = 600$ V				25			25	μA
Thermal										
Thermal resistance junction to sink ⁽²⁾	$R_{th(j-s)}$	$\lambda_{paste} = 3,4$ W/mK (PSX)						1,25		K/W
Dynamic										
Peak recovery current	I_{RM}					25 125 150		94,73 132,13 145,11		A
Reverse recovery time	t_{rr}					25 125 150		23,52 35,98 39,84		ns
Recovered charge	Q_r	$di/dt=5166$ A/μs $di/dt=5621$ A/μs $di/dt=5879$ A/μs	0/15	400	50	25 125 150		1,1 2,52 3,07		μC
Reverse recovered energy	E_{rec}					25 125 150		0,157 0,416 0,527		mWs
Peak rate of fall of recovery current	$(di_r/dt)_{max}$					25 125 150		17518,28 9909,62 9732,57		A/μs



Vincotech

Characteristic Values

Parameter	Symbol	Conditions					Values			Unit
		V_{GE} [V] V_{GS} [V]	V_{CE} [V] V_{DS} [V] V_F [V]	I_C [A] I_D [A] I_F [A]	T_j [°C]	Min	Typ	Max		

Rectifier Diode

Static

Forward voltage	V_F			5	25 125 150		0,899 0,78 0,744	1,1 ⁽¹⁾	V
Reverse leakage current	I_R	$V_r = 1600$ V			25 150			100 1000	μA

Thermal

Thermal resistance junction to sink ⁽²⁾	$R_{th(j-s)}$	$\lambda_{paste} = 3,4$ W/mK (PSX)					1,41		K/W
--	---------------	---------------------------------------	--	--	--	--	------	--	-----

PFC Shunt

Static

Resistance	R						6,8		mΩ
Tolerance						-1		1	%
Temperature coefficient	tc							100	ppm/K

Capacitor (PFC)

Static

Capacitance	C	DC bias voltage = 0 V			25		33		nF
Tolerance						-5		5	%



Vincotech

Characteristic Values

Parameter	Symbol	Conditions					Values			Unit
		V_{GS} [V]	V_{GE} [V]	V_{DS} [V]	V_{CE} [V]	I_D [A]	I_C [A]	T_j [°C]	Min	

Thermistor

Static

Rated resistance	R					25		22		kΩ
Deviation of R100	$A_{R/R}$	$R_{100} = 1484 \Omega$				100	-5		5	%
Power dissipation	P					25		130		mW
Power dissipation constant	d					25		1,5		mW/K
B-value	$B_{(25/50)}$	Tol. $\pm 1 \%$						3962		K
B-value	$B_{(25/100)}$	Tol. $\pm 1 \%$						4000		K
Vincotech Thermistor Reference									I	

⁽¹⁾ Value at chip level

⁽²⁾ Only valid with pre-applied Vincotech thermal interface material.



Inverter Switch Characteristics

figure 1. IGBT

Typical output characteristics

$$I_C = f(V_{CE})$$

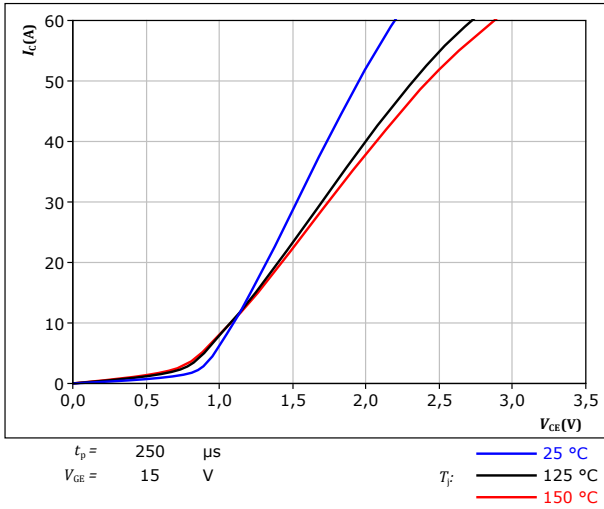

figure 2. IGBT

Typical output characteristics

$$I_C = f(V_{CE})$$

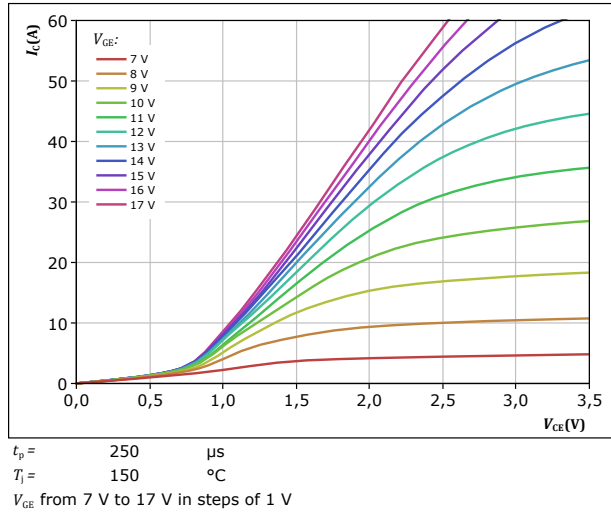

figure 3. IGBT

Typical transfer characteristics

$$I_C = f(V_{GE})$$

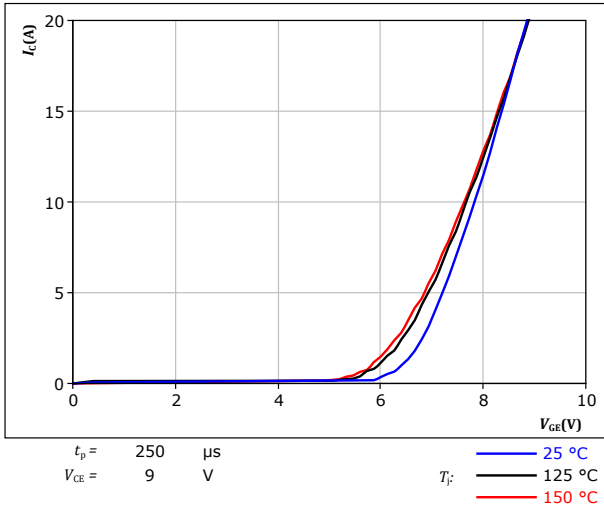
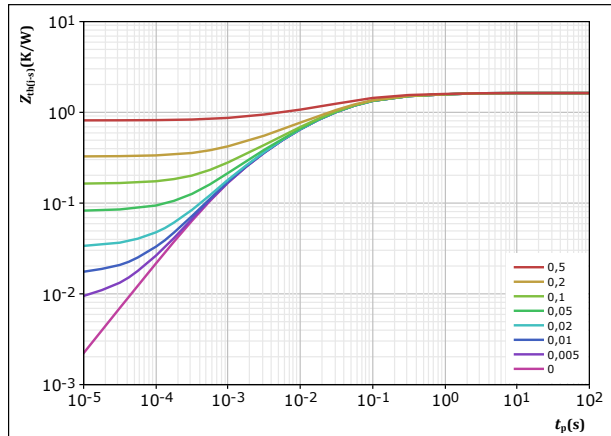

figure 4. IGBT

Transient thermal impedance as a function of pulse width

$$Z_{th(j-s)} = f(t_p)$$



$D = t_p / T$
 $R_{th(j-s)} = 1,631 \text{ K/W}$

IGBT thermal model values

R (K/W)	τ (s)
1,22E-01	1,15E+00
3,54E-01	1,26E-01
6,61E-01	2,93E-02
3,54E-01	5,82E-03
1,40E-01	1,02E-03



Inverter Switch Characteristics

figure 5. IGBT

Safe operating area
 $I_C = f(V_{CE})$

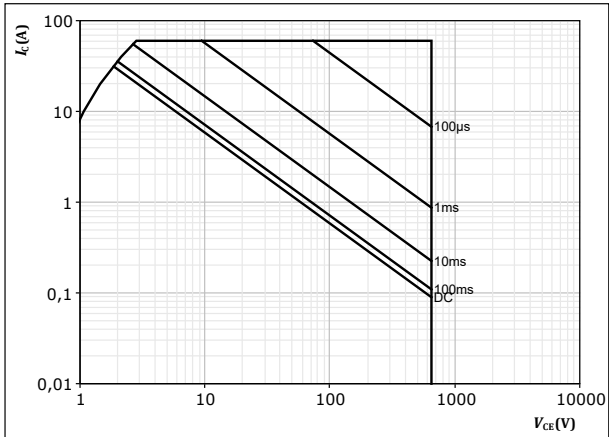

$D =$ single pulse
 $T_s = 80$ °C
 $V_{GE} = 15$ V
 $T_j = T_{jmax}$

figure 6. IGBT

Gate voltage vs gate charge
 $V_{GE} = f(Q_g)$

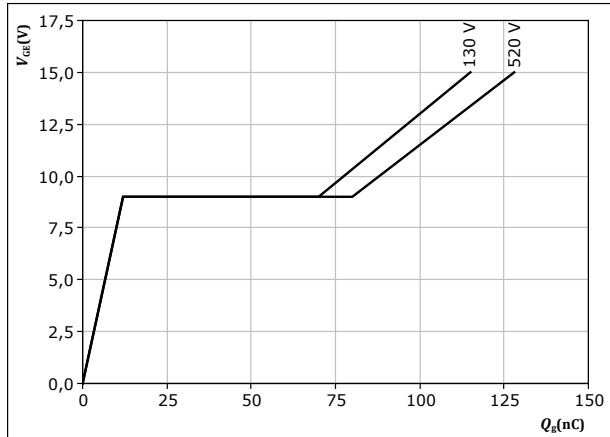

$I_C = 20$ A
 $T_j = 25$ °C



Inverter Diode Characteristics

figure 7. FWD

Typical forward characteristics

$$I_F = f(V_F)$$

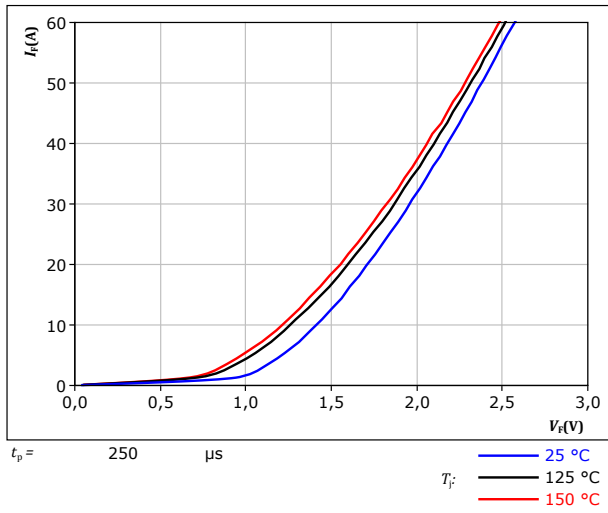
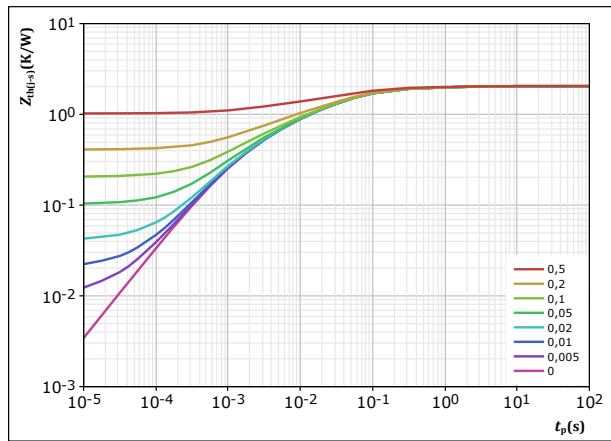

figure 8. FWD

Transient thermal impedance as a function of pulse width

$$Z_{th(j-s)} = f(t_p)$$



$D = t_p / T$
 $R_{th(j-s)} = 2,046 \text{ K/W}$
 FWD thermal model values

R (K/W)	τ (s)
1,18E-01	1,59E+00
4,10E-01	1,36E-01
7,87E-01	3,23E-02
4,93E-01	5,55E-03
2,39E-01	1,05E-03



PFC Sw. Inverse Diode Characteristics

figure 9. FWD

Typical forward characteristics

$$I_F = f(V_F)$$

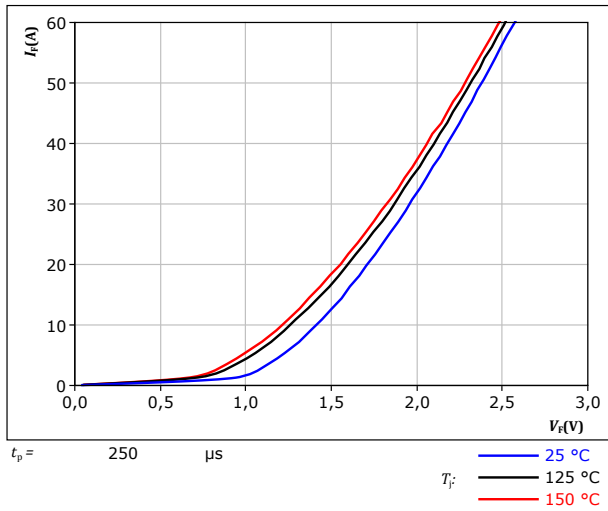
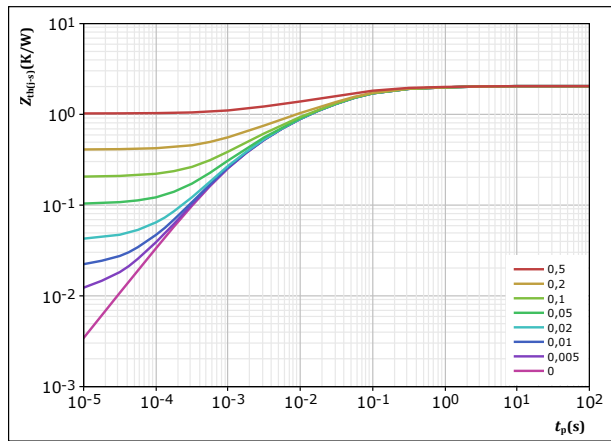

figure 10. FWD

Transient thermal impedance as a function of pulse width

$$Z_{th(j-s)} = f(t_p)$$



$D =$ t_p / T
 $R_{th(j-s)} = 2,046$ K/W
 FWD thermal model values

R (K/W)	τ (s)
1,18E-01	1,59E+00
4,10E-01	1,36E-01
7,87E-01	3,23E-02
4,93E-01	5,55E-03
2,39E-01	1,05E-03



PFC Switch Characteristics

figure 11. IGBT

Typical output characteristics

$I_C = f(V_{CE})$

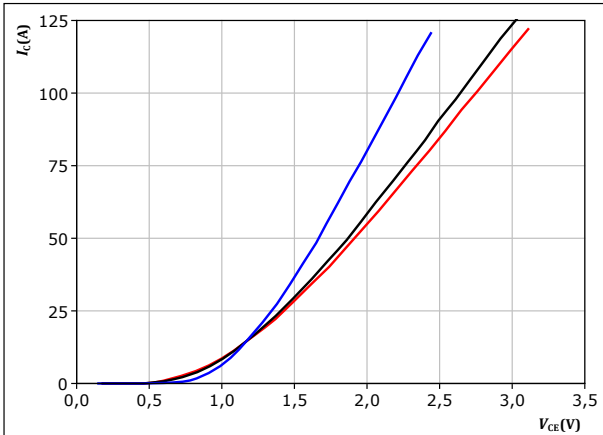

$t_p = 250 \mu s$
 $V_{GE} = 15 V$
 $T_j:$ — 25 °C
— 125 °C
— 150 °C

figure 12. IGBT

Typical output characteristics

$I_C = f(V_{CE})$

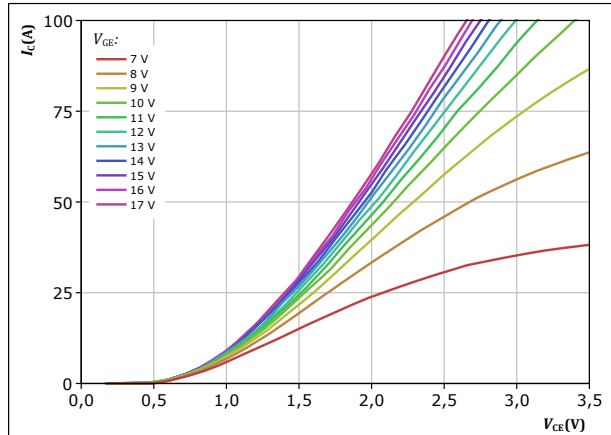

$t_p = 250 \mu s$
 $T_j = 150 \text{ °C}$
 V_{GE} from 7 V to 17 V in steps of 1 V

figure 13. IGBT

Typical transfer characteristics

$I_C = f(V_{GE})$

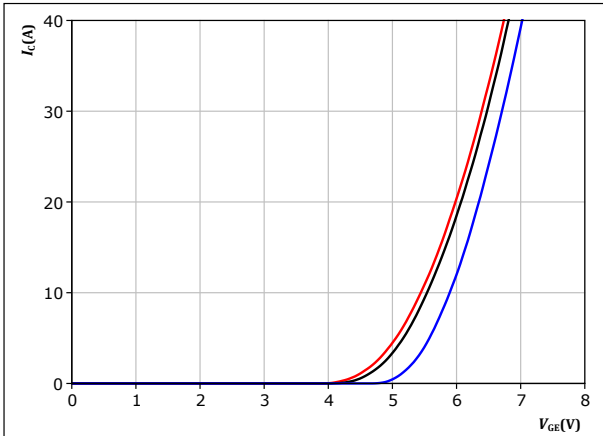

$t_p = 250 \mu s$
 $V_{CE} = 10 V$
 $T_j:$ — 25 °C
— 125 °C
— 150 °C

figure 14. IGBT

Transient thermal impedance as a function of pulse width

$Z_{th(j-s)} = f(t_p)$

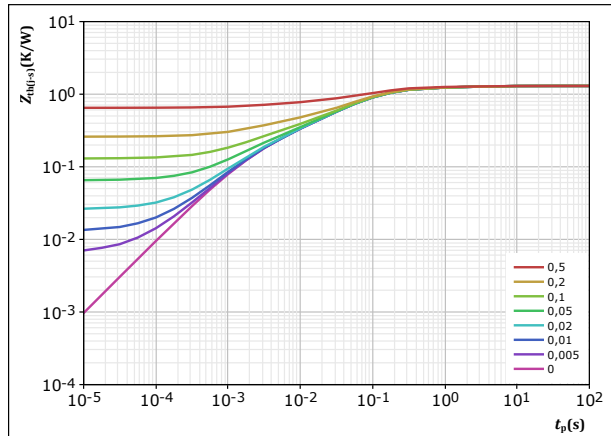

$D = t_p / T$
 $R_{th(j-s)} = 1,299 \text{ K/W}$
IGBT thermal model values

R (K/W)	τ (s)
7,67E-02	2,84E+00
1,78E-01	3,36E-01
7,37E-01	7,35E-02
1,98E-01	9,72E-03
1,09E-01	1,65E-03



PFC Switch Characteristics

figure 15. IGBT

Safe operating area

$I_C = f(V_{CE})$

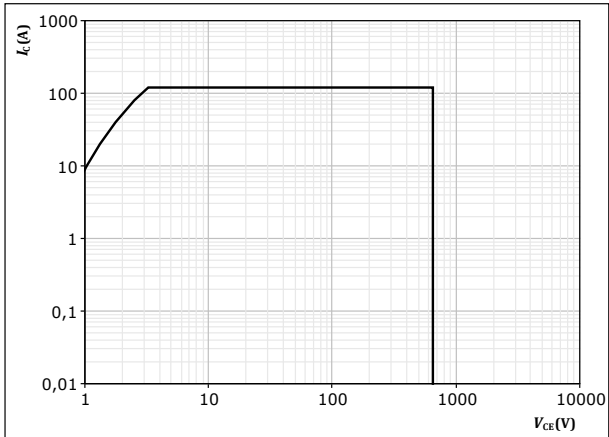

D = single pulse
T_s = 80 °C
V_{GE} = 15 V
T_j = T_{jmax}

figure 16. IGBT

Gate voltage vs gate charge

$V_{GE} = f(Q_g)$

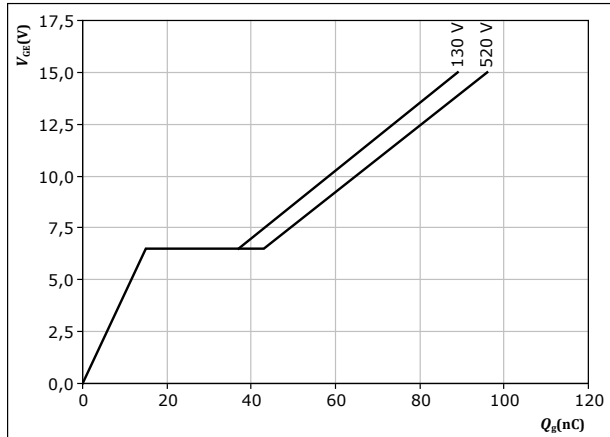

I_C = 20 A
T_j = 25 °C



PFC Diode Characteristics

figure 17. FWD

Typical forward characteristics

$$I_F = f(V_F)$$

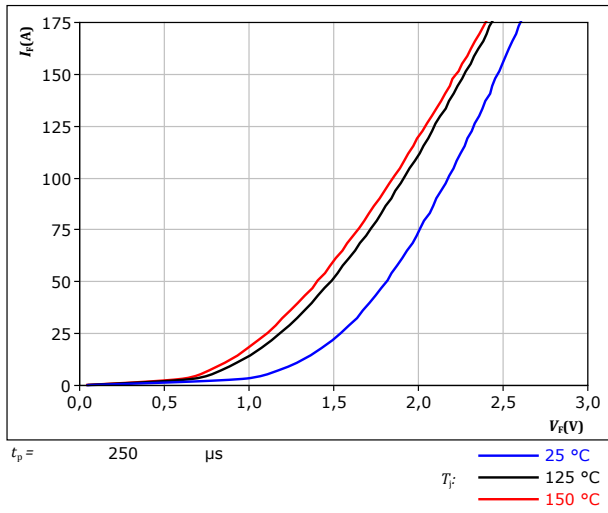
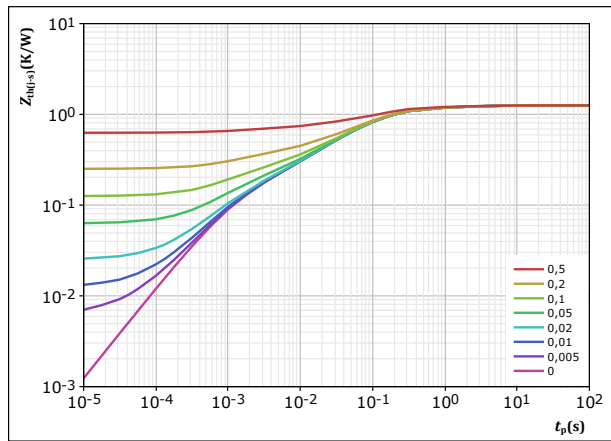

figure 18. FWD

Transient thermal impedance as a function of pulse width

$$Z_{th(j-s)} = f(t_p)$$



$D = t_p / T$
 $R_{th(j-s)} = 1,254 \text{ K/W}$
 FWD thermal model values

R (K/W)	τ (s)
6,51E-02	3,13E+00
1,82E-01	4,53E-01
6,95E-01	8,72E-02
2,01E-01	1,20E-02
1,12E-01	1,13E-03



Rectifier Diode Characteristics

figure 19. Rectifier

Typical forward characteristics

$$I_F = f(V_F)$$

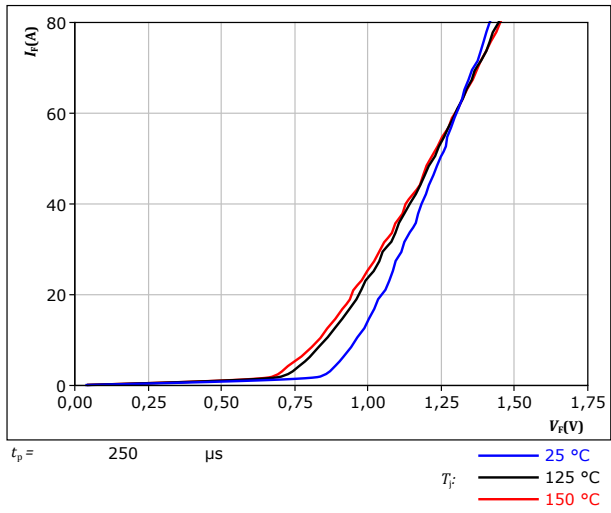
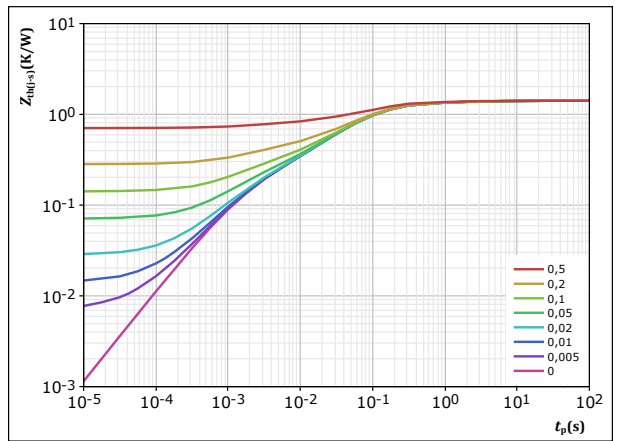

figure 20. Rectifier

Transient thermal impedance as a function of pulse width

$$Z_{th(j-s)} = f(t_p)$$



$D =$	t_p / T	
$R_{th(j-s)} =$	1,413	K/W
Rectifier thermal model values		
R (K/W)	τ (s)	
3,51E-02	6,79E+00	
1,86E-01	5,94E-01	
8,53E-01	8,05E-02	
2,17E-01	1,21E-02	
1,22E-01	1,43E-03	



Thermistor Characteristics

figure 21. Thermistor

Typical NTC characteristic as function of temperature

$$R_T = f(T)$$

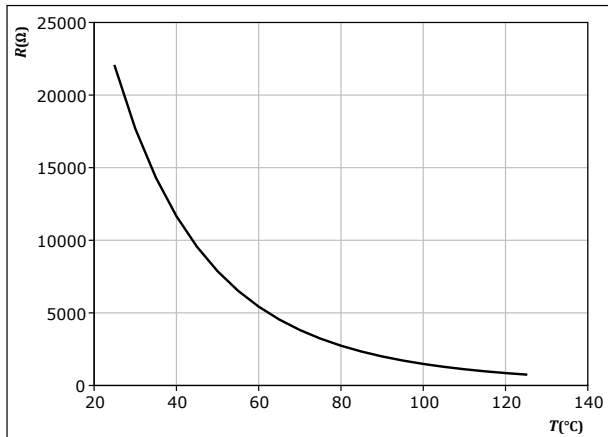



Inverter Switching Characteristics

figure 22. IGBT

Typical switching energy losses as a function of collector current
 $E = f(I_c)$

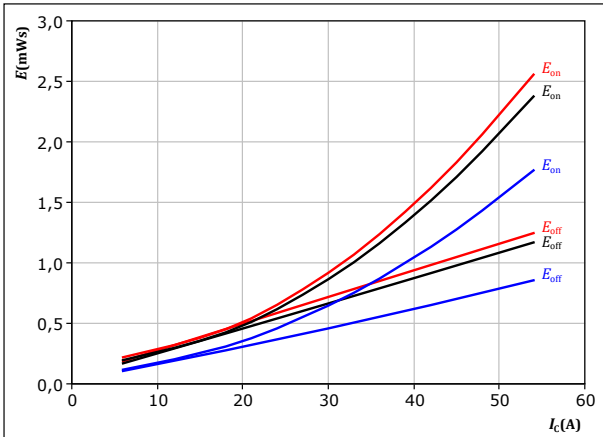

With an inductive load at

$V_{CE} = 350$ V	$T_j = 25$ °C
$V_{GE} = \pm 15$ V	$T_j = 125$ °C
$R_{g(on)} = 16$ Ω	$T_j = 150$ °C
$R_{g(off)} = 16$ Ω	

figure 23. IGBT

Typical switching energy losses as a function of IGBT turn on gate resistor
 $E = f(R_g)$

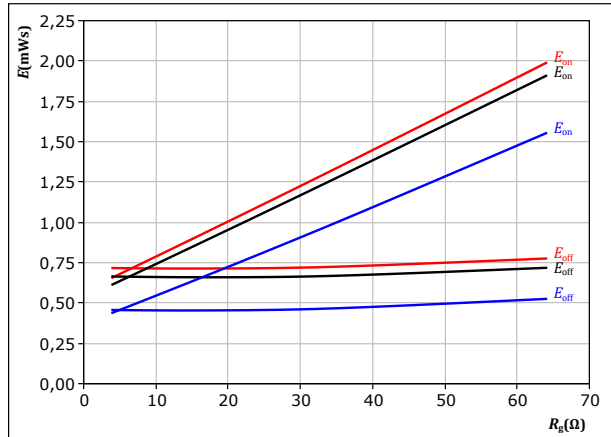

With an inductive load at

$V_{CE} = 350$ V	$T_j = 25$ °C
$V_{GE} = \pm 15$ V	$T_j = 125$ °C
$I_c = 30$ A	$T_j = 150$ °C

figure 24. FWD

Typical reverse recovered energy loss as a function of collector current
 $E_{rec} = f(I_c)$

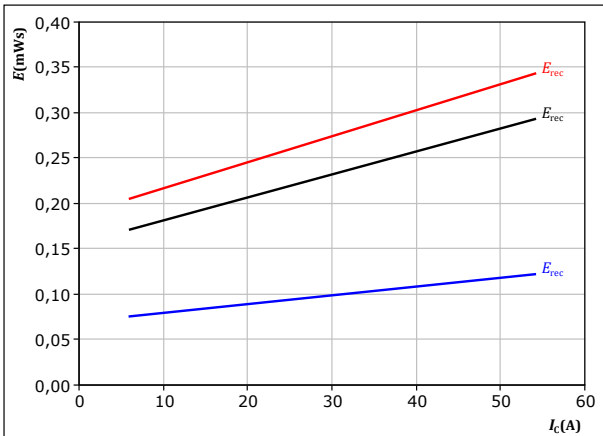

With an inductive load at

$V_{CE} = 350$ V	$T_j = 25$ °C
$V_{GE} = \pm 15$ V	$T_j = 125$ °C
$R_{g(on)} = 16$ Ω	$T_j = 150$ °C

figure 25. FWD

Typical reverse recovered energy loss as a function of IGBT turn on gate resistor
 $E_{rec} = f(R_g)$

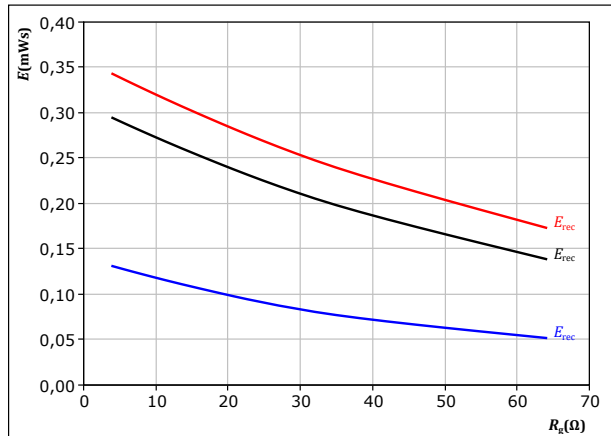

With an inductive load at

$V_{CE} = 350$ V	$T_j = 25$ °C
$V_{GE} = \pm 15$ V	$T_j = 125$ °C
$I_c = 30$ A	$T_j = 150$ °C



Inverter Switching Characteristics

figure 26. IGBT

Typical switching times as a function of collector current
 $t = f(I_c)$

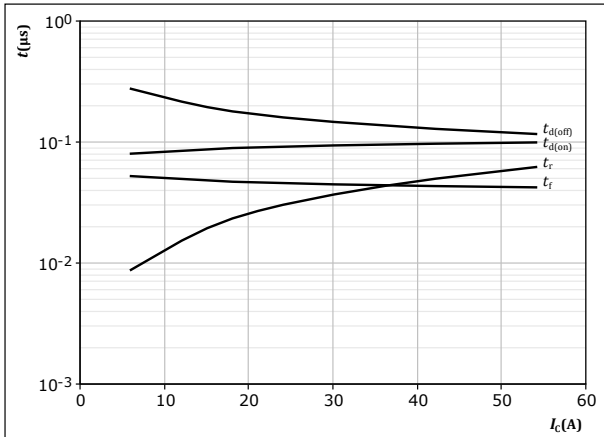

With an inductive load at
 $T_j = 150 \text{ }^\circ\text{C}$
 $V_{CE} = 350 \text{ V}$
 $V_{GE} = \pm 15 \text{ V}$
 $R_{gon} = 16 \text{ } \Omega$
 $R_{goff} = 16 \text{ } \Omega$

figure 27. IGBT

Typical switching times as a function of IGBT turn on gate resistor
 $t = f(R_g)$

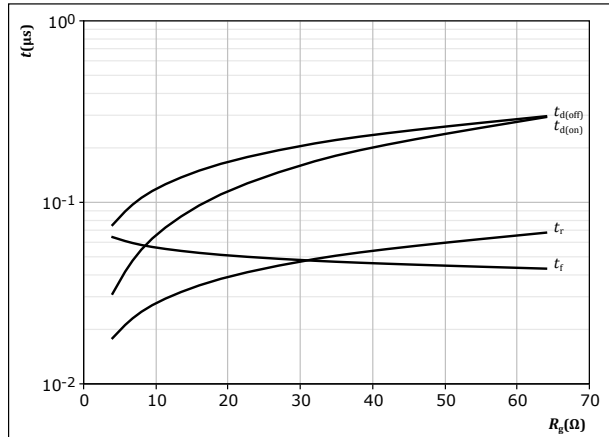

With an inductive load at
 $T_j = 150 \text{ }^\circ\text{C}$
 $V_{CE} = 350 \text{ V}$
 $V_{GE} = \pm 15 \text{ V}$
 $I_c = 30 \text{ A}$

figure 28. FWD

Typical reverse recovery time as a function of collector current
 $t_{rr} = f(I_c)$

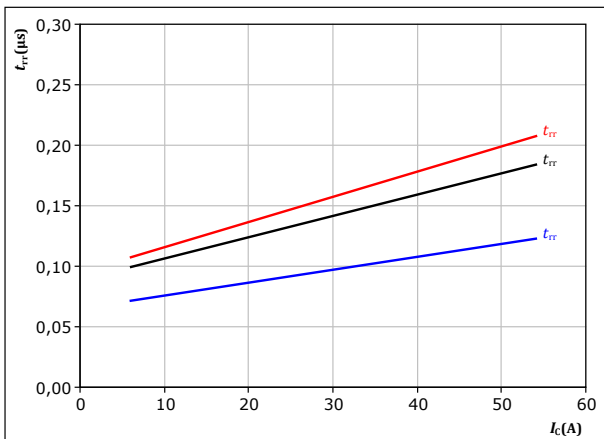

With an inductive load at
 $V_{CE} = 350 \text{ V}$
 $V_{GE} = \pm 15 \text{ V}$
 $R_{gon} = 16 \text{ } \Omega$
 $T_j:$ — 25 °C
— 125 °C
— 150 °C

figure 29. FWD

Typical reverse recovery time as a function of IGBT turn on gate resistor
 $t_{rr} = f(R_{gon})$

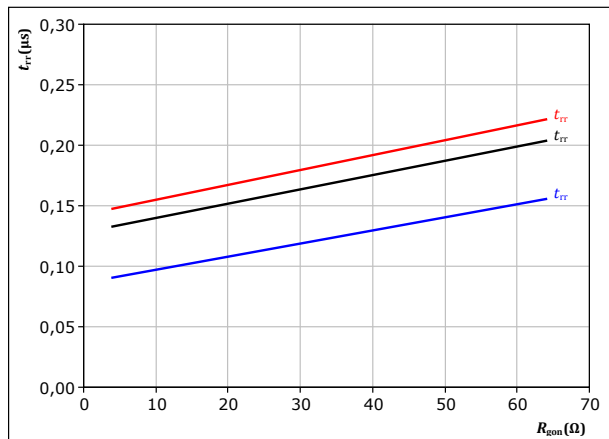

With an inductive load at
 $V_{CE} = 350 \text{ V}$
 $V_{GE} = \pm 15 \text{ V}$
 $I_c = 30 \text{ A}$
 $T_j:$ — 25 °C
— 125 °C
— 150 °C



Inverter Switching Characteristics

figure 30. FWD

Typical recovered charge as a function of collector current

$$Q_r = f(I_c)$$

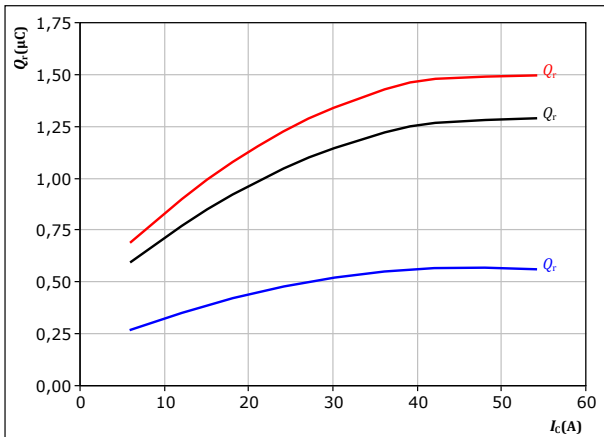

With an inductive load at

$V_{CE} = 350$ V
 $V_{GE} = \pm 15$ V
 $R_{gon} = 16$ Ω
 $T_j:$ — 25 °C
 — 125 °C
 — 150 °C

figure 31. FWD

Typical recovered charge as a function of IGBT turn on gate resistor

$$Q_r = f(R_{gon})$$

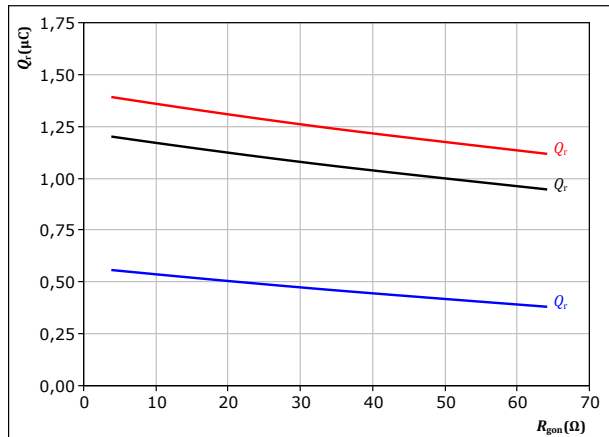

With an inductive load at

$V_{CE} = 350$ V
 $V_{GE} = \pm 15$ V
 $I_c = 30$ A
 $T_j:$ — 25 °C
 — 125 °C
 — 150 °C

figure 32. FWD

Typical peak reverse recovery current as a function of collector current

$$I_{RM} = f(I_c)$$

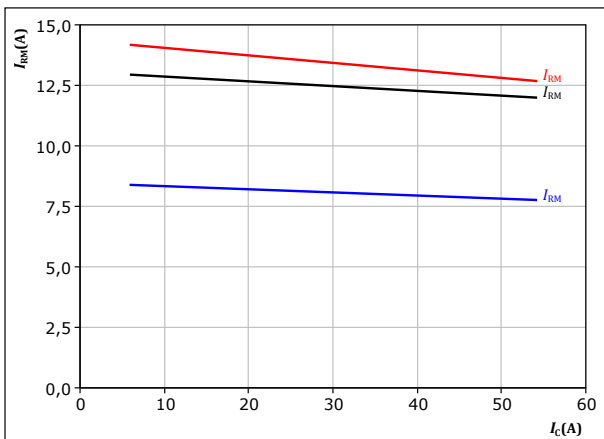

With an inductive load at

$V_{CE} = 350$ V
 $V_{GE} = \pm 15$ V
 $R_{gon} = 16$ Ω
 $T_j:$ — 25 °C
 — 125 °C
 — 150 °C

figure 33. FWD

Typical peak reverse recovery current as a function of IGBT turn on gate resistor

$$I_{RM} = f(R_{gon})$$

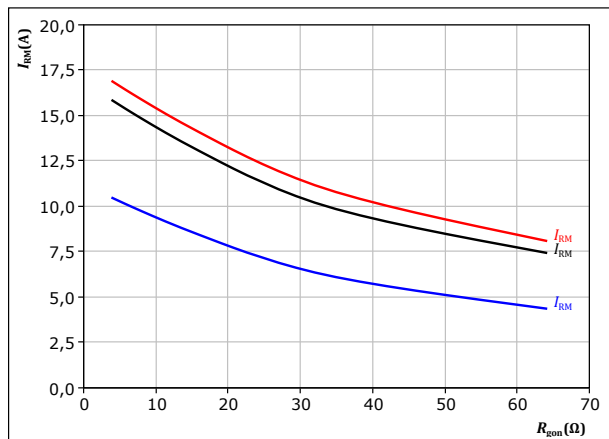

With an inductive load at

$V_{CE} = 350$ V
 $V_{GE} = \pm 15$ V
 $I_c = 30$ A
 $T_j:$ — 25 °C
 — 125 °C
 — 150 °C



Inverter Switching Characteristics

figure 34. FWD

Typical rate of fall of forward and reverse recovery current as a function of collector current
 $di_f/dt, di_{rr}/dt = f(I_C)$

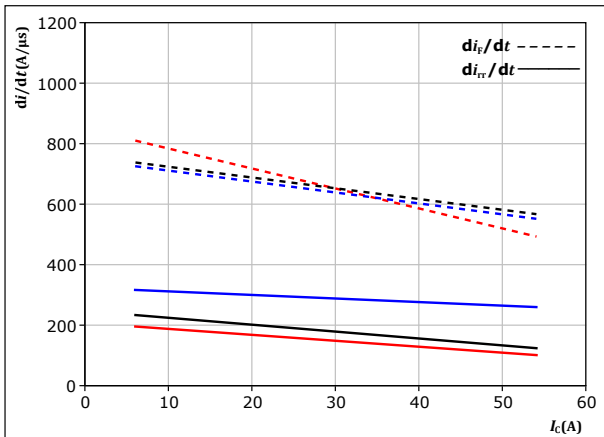

With an inductive load at

$V_{CE} = 350 \text{ V}$
 $V_{GE} = \pm 15 \text{ V}$
 $R_{gon} = 16 \ \Omega$

$T_j:$
— 25 °C
— 125 °C
— 150 °C

figure 35. FWD

Typical rate of fall of forward and reverse recovery current as a function of turn on gate resistor
 $di_f/dt, di_{rr}/dt = f(R_{gon})$

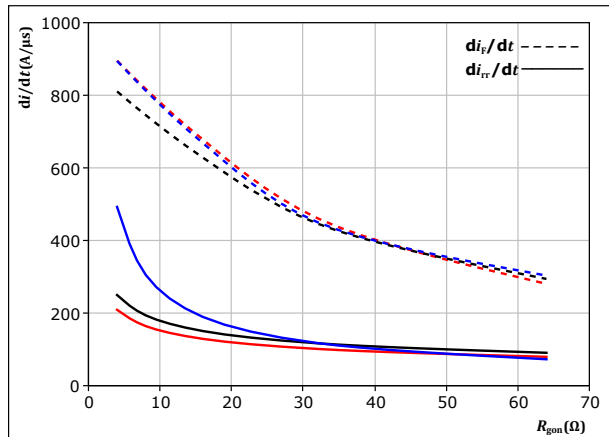

With an inductive load at

$V_{CE} = 350 \text{ V}$
 $V_{GE} = \pm 15 \text{ V}$
 $I_C = 30 \text{ A}$

$T_j:$
— 25 °C
— 125 °C
— 150 °C

figure 36. IGBT

Reverse bias safe operating area

$I_C = f(V_{CE})$

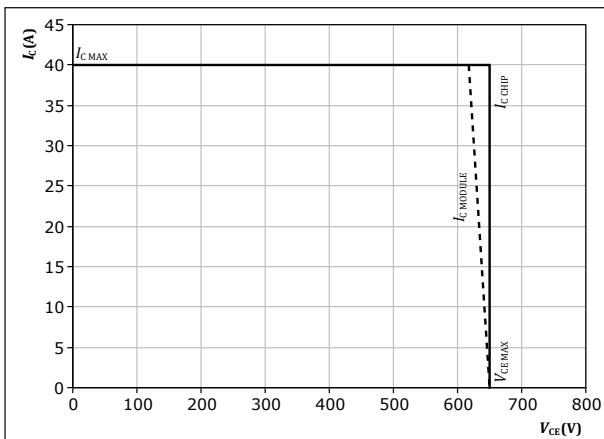

At $T_j = 150 \text{ °C}$
 $R_{gon} = 16 \ \Omega$
 $R_{goff} = 16 \ \Omega$



PFC Switching Characteristics

figure 37. IGBT

Typical switching energy losses as a function of collector current
 $E = f(I_c)$

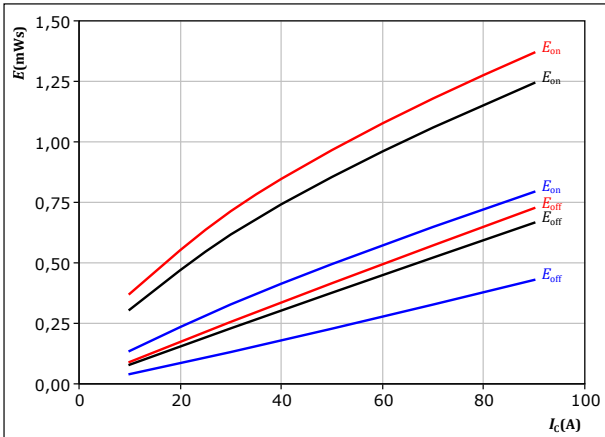

With an inductive load at
 $V_{CE} = 400$ V
 $V_{GE} = 0/15$ V
 $R_{gon} = 4$ Ω
 $R_{goff} = 4$ Ω
 T_j : 25 °C, 125 °C, 150 °C

figure 38. IGBT

Typical switching energy losses as a function of IGBT turn on gate resistor
 $E = f(R_g)$

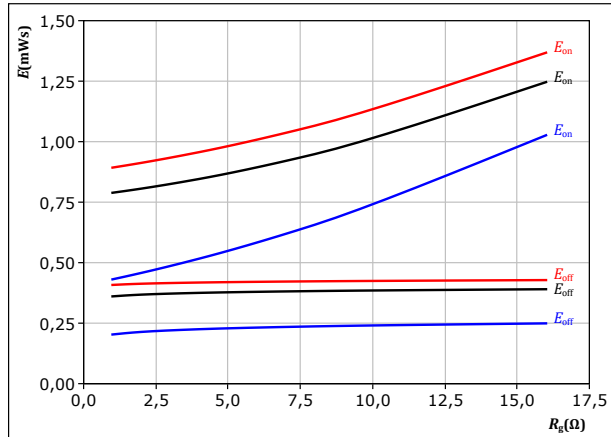

With an inductive load at
 $V_{CE} = 400$ V
 $V_{GE} = 0/15$ V
 $I_c = 50$ A
 T_j : 25 °C, 125 °C, 150 °C

figure 39. FWD

Typical reverse recovered energy loss as a function of collector current
 $E_{rec} = f(I_c)$

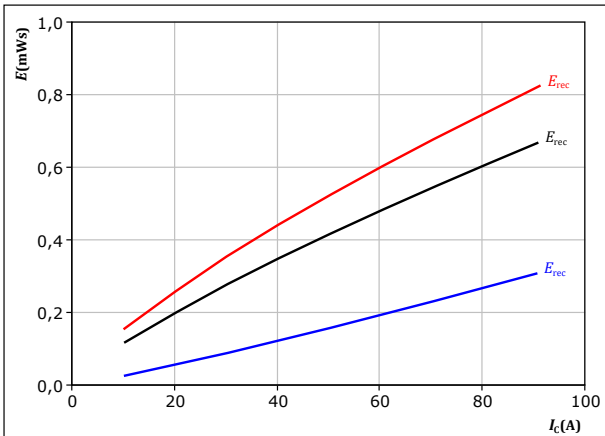

With an inductive load at
 $V_{CE} = 400$ V
 $V_{GE} = 0/15$ V
 $R_{gon} = 4$ Ω
 T_j : 25 °C, 125 °C, 150 °C

figure 40. FWD

Typical reverse recovered energy loss as a function of IGBT turn on gate resistor
 $E_{rec} = f(R_g)$

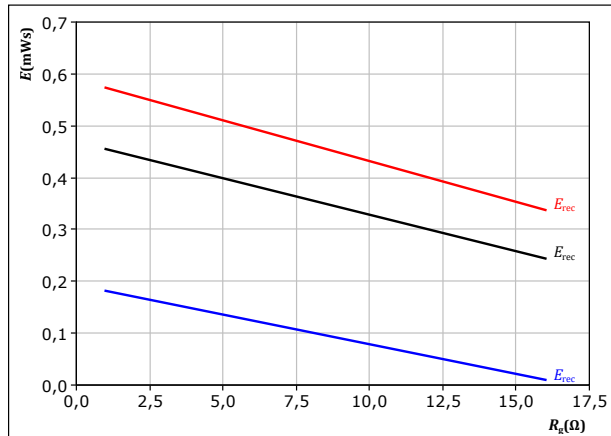

With an inductive load at
 $V_{CE} = 400$ V
 $V_{GE} = 0/15$ V
 $I_c = 50$ A
 T_j : 25 °C, 125 °C, 150 °C



PFC Switching Characteristics

figure 41. IGBT

Typical switching times as a function of collector current
 $t = f(I_c)$

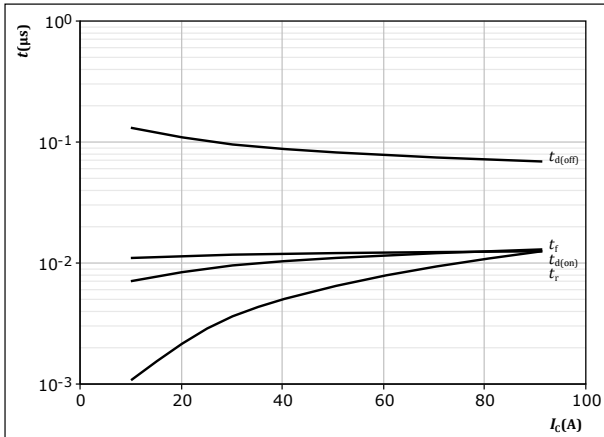

With an inductive load at
 $T_j = 150 \text{ }^\circ\text{C}$
 $V_{CE} = 400 \text{ V}$
 $V_{GE} = 0/15 \text{ V}$
 $R_{gon} = 4 \text{ } \Omega$
 $R_{goff} = 4 \text{ } \Omega$

figure 42. IGBT

Typical switching times as a function of IGBT turn on gate resistor
 $t = f(R_g)$

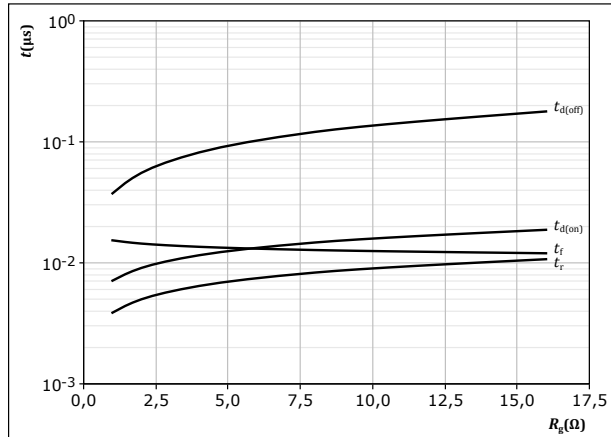

With an inductive load at
 $T_j = 150 \text{ }^\circ\text{C}$
 $V_{CE} = 400 \text{ V}$
 $V_{GE} = 0/15 \text{ V}$
 $I_c = 50 \text{ A}$

figure 43. FWD

Typical reverse recovery time as a function of collector current
 $t_{rr} = f(I_c)$

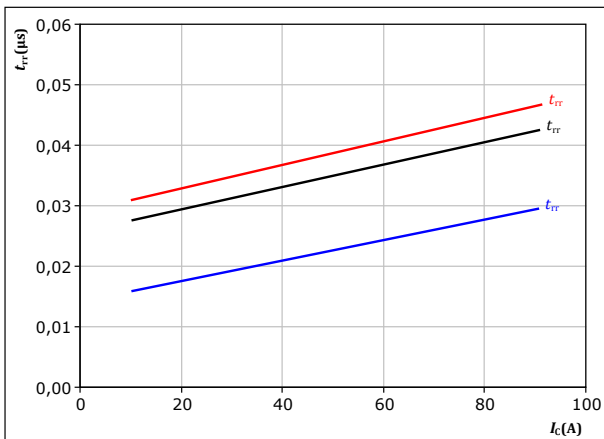

With an inductive load at
 $V_{CE} = 400 \text{ V}$
 $V_{GE} = 0/15 \text{ V}$
 $R_{gon} = 4 \text{ } \Omega$
 $T_j:$ — 25 °C
 — 125 °C
 — 150 °C

figure 44. FWD

Typical reverse recovery time as a function of IGBT turn on gate resistor
 $t_{rr} = f(R_{gon})$

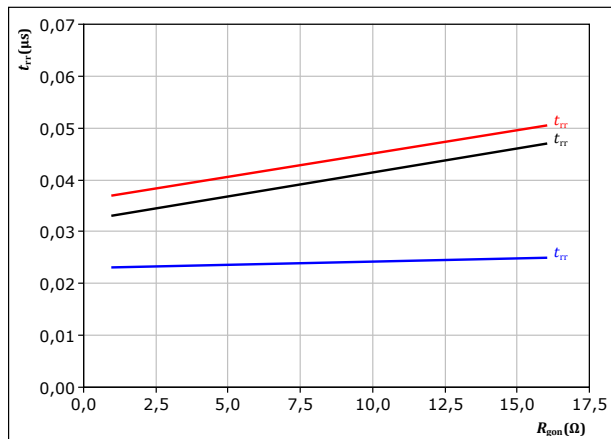

With an inductive load at
 $V_{CE} = 400 \text{ V}$
 $V_{GE} = 0/15 \text{ V}$
 $I_c = 50 \text{ A}$
 $T_j:$ — 25 °C
 — 125 °C
 — 150 °C



PFC Switching Characteristics

figure 45. FWD

Typical recovered charge as a function of collector current

$$Q_r = f(I_c)$$

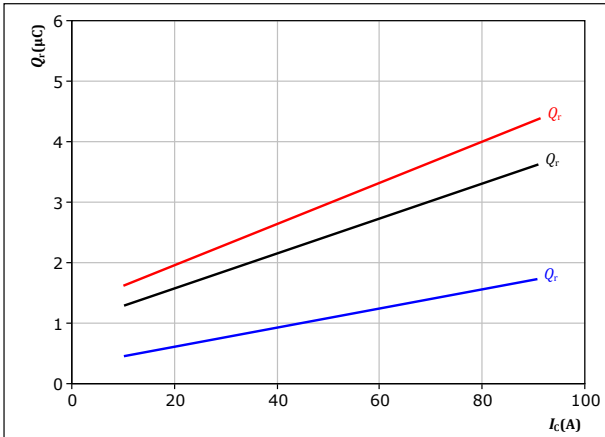

With an inductive load at

$V_{CE} = 400$ V
 $V_{GE} = 0/15$ V
 $R_{gon} = 4$ Ω

T_j : — 25 °C
— 125 °C
— 150 °C

figure 46. FWD

Typical recovered charge as a function of IGBT turn on gate resistor

$$Q_r = f(R_{gon})$$

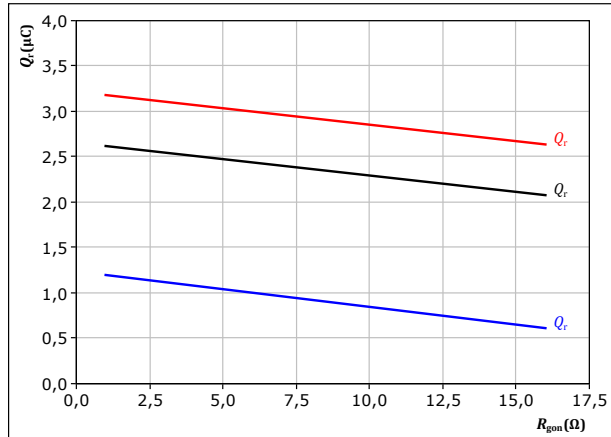

With an inductive load at

$V_{CE} = 400$ V
 $V_{GE} = 0/15$ V
 $I_c = 50$ A

T_j : — 25 °C
— 125 °C
— 150 °C

figure 47. FWD

Typical peak reverse recovery current as a function of collector current

$$I_{RM} = f(I_c)$$

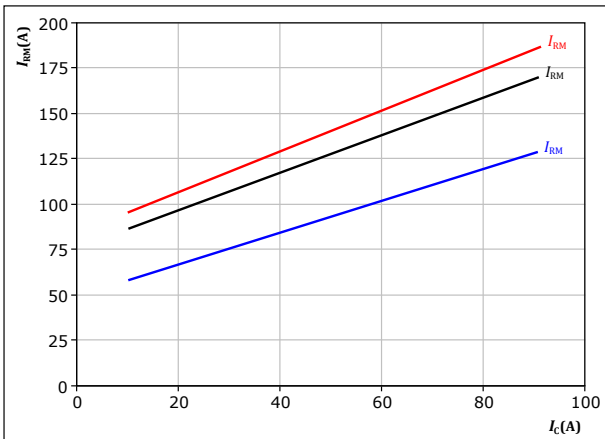

With an inductive load at

$V_{CE} = 400$ V
 $V_{GE} = 0/15$ V
 $R_{gon} = 4$ Ω

T_j : — 25 °C
— 125 °C
— 150 °C

figure 48. FWD

Typical peak reverse recovery current as a function of IGBT turn on gate resistor

$$I_{RM} = f(R_{gon})$$

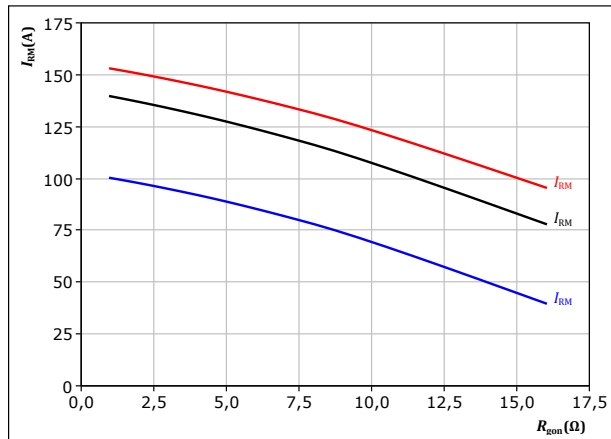

With an inductive load at

$V_{CE} = 400$ V
 $V_{GE} = 0/15$ V
 $I_c = 50$ A

T_j : — 25 °C
— 125 °C
— 150 °C



PFC Switching Characteristics

figure 49. FWD

Typical rate of fall of forward and reverse recovery current as a function of collector current
 $di_f/dt, di_{rr}/dt = f(I_c)$

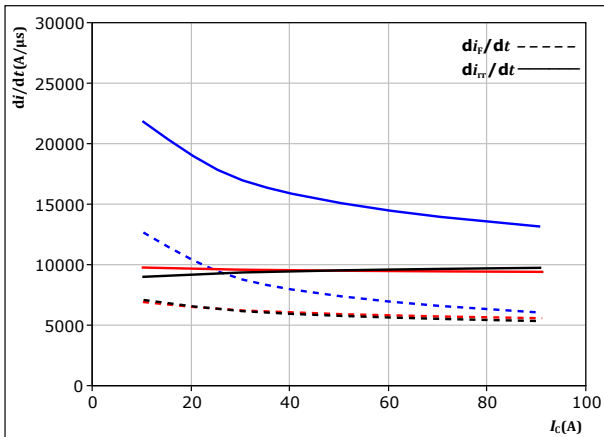

With an inductive load at

$V_{CE} = 400$ V
 $V_{GE} = 0/15$ V
 $R_{gon} = 4$ Ω

T_j : — 25 °C
 — 125 °C
 — 150 °C

figure 50. FWD

Typical rate of fall of forward and reverse recovery current as a function of turn on gate resistor
 $di_f/dt, di_{rr}/dt = f(R_{gon})$

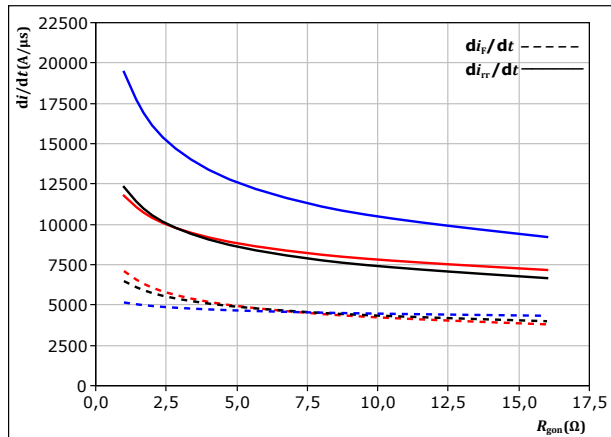

With an inductive load at

$V_{CE} = 400$ V
 $V_{GE} = 0/15$ V
 $I_c = 50$ A

T_j : — 25 °C
 — 125 °C
 — 150 °C

figure 51. IGBT

Reverse bias safe operating area

$I_c = f(V_{CE})$

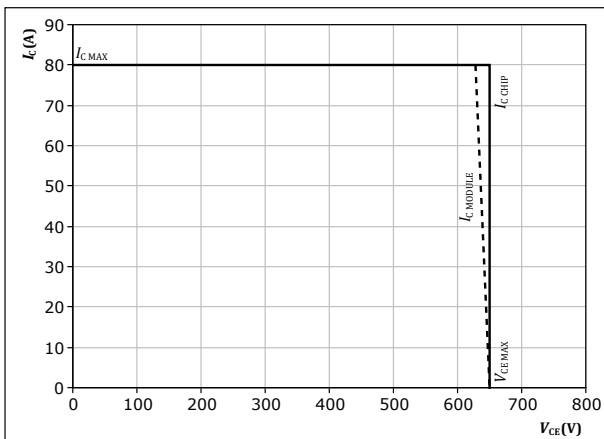

At $T_j = 150$ °C
 $R_{gon} = 4$ Ω
 $R_{goff} = 4$ Ω



Switching Definitions

figure 52. IGBT

Turn-off Switching Waveforms & definition of t_{doff} , t_{Eoff} (t_{Eoff} = integrating time for E_{off})

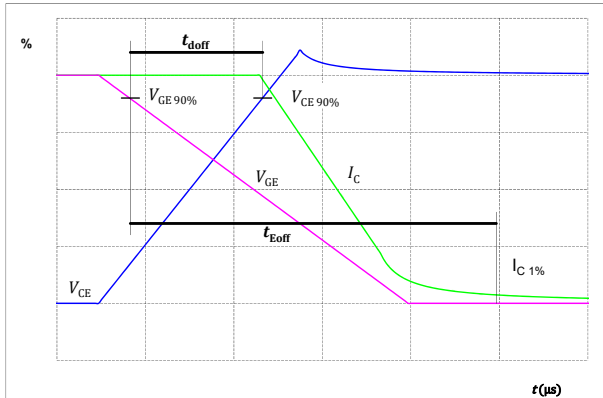

figure 53. IGBT

Turn-on Switching Waveforms & definition of t_{don} , t_{Eon} (t_{Eon} = integrating time for E_{on})

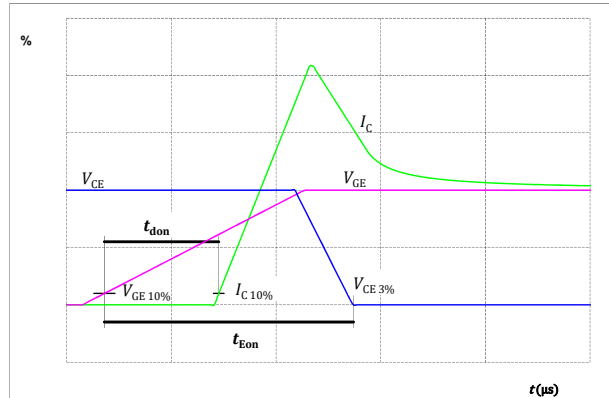

figure 54. IGBT

Turn-off Switching Waveforms & definition of t_f

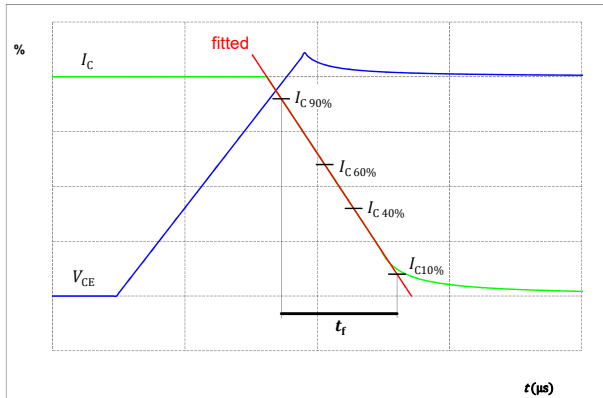
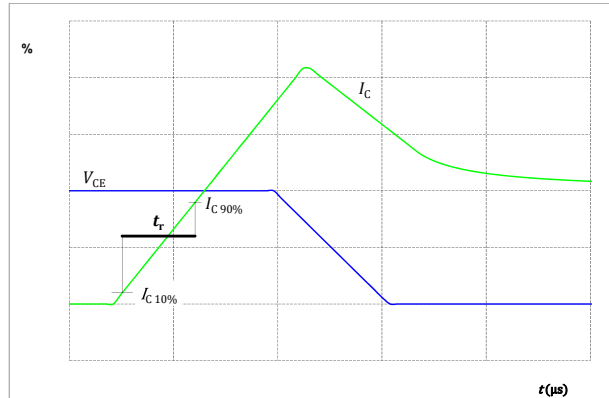

figure 55. IGBT

Turn-on Switching Waveforms & definition of t_r





Switching Definitions

figure 56. FWD

Turn-off Switching Waveforms & definition of t_{rr}

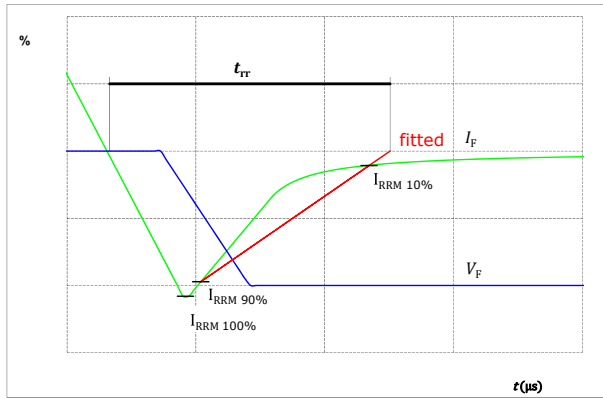
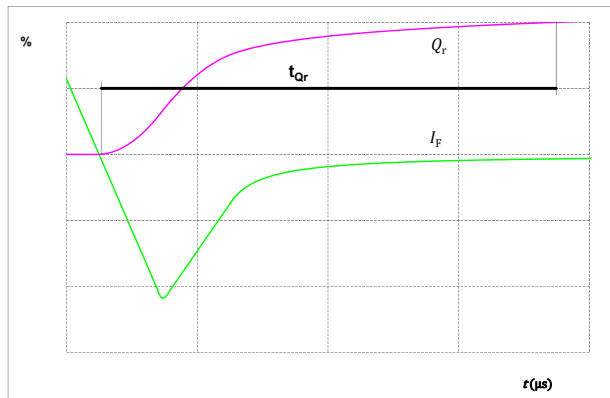

figure 57. FWD

Turn-on Switching Waveforms & definition of t_{Qr} (t_{Qr} = integrating time for Q_r)





Vincotech

10-FU07PPA020I7-M685B56
datasheet

Ordering Code	
Version	Ordering Code
Without thermal paste	10-FU07PPA020I7-M685B56
With thermal paste (5,2 W/mK, PTM6000HV)	10-FU07PPA020I7-M685B56-/-7/
With thermal paste (3,4 W/mK, PSX-P7)	10-FU07PPA020I7-M685B56-/-3/

Marking						
	Text	Name NN-NNNNNNNNNNNNNN- TTTTTIVV	Date code WWYY	UL & VIN UL VIN	Lot LLLLL	Serial SSSS
	Datamatrix	Type&Ver TTTTTIVV	Lot number LLLLL	Serial SSSS	Date code WWYY	

Outline			
Pin table [mm]			
Pin	X	Y	Function
1	33,5	0	DC-Rect
2	30,7	0	DC-SH
3	28	0	S2SH2
4	25,3	0	S1SH2
5	22,6	0	DC-PFC
6	19,9	0	G27
7	17,2	0	S27
8	13,5	0	G11
9	10,8	0	DC-1
10	8,1	0	G13
11	5,4	0	DC-2
12	2,7	0	G15
13	0	0	DC-3
14	0	8,6	Therm1
15	0	11,45	Therm2
16	0	19,8	G16
17	0	22,5	Ph3
18	6	19,8	G14
19	6	22,5	Ph2
20	12	19,8	G12
21	12	22,5	Ph1
22	17,7	22,5	DC+INV
23	20,5	22,5	DC+PFC
24	26,5	22,5	PFC
25	33,5	22,5	DC+Rect
26	33,5	15	ACIn1
27	33,5	7,5	ACIn2

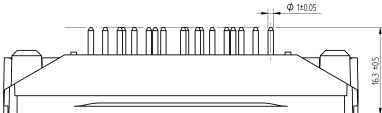
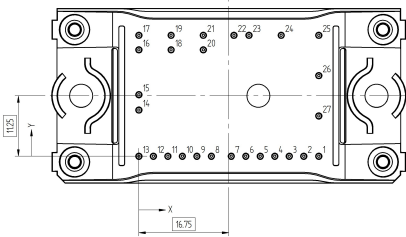
Tolerance of positions: ±0,05mm at the end of pins
Dimension of coordinate axis is only offset without tolerance



Vincotech

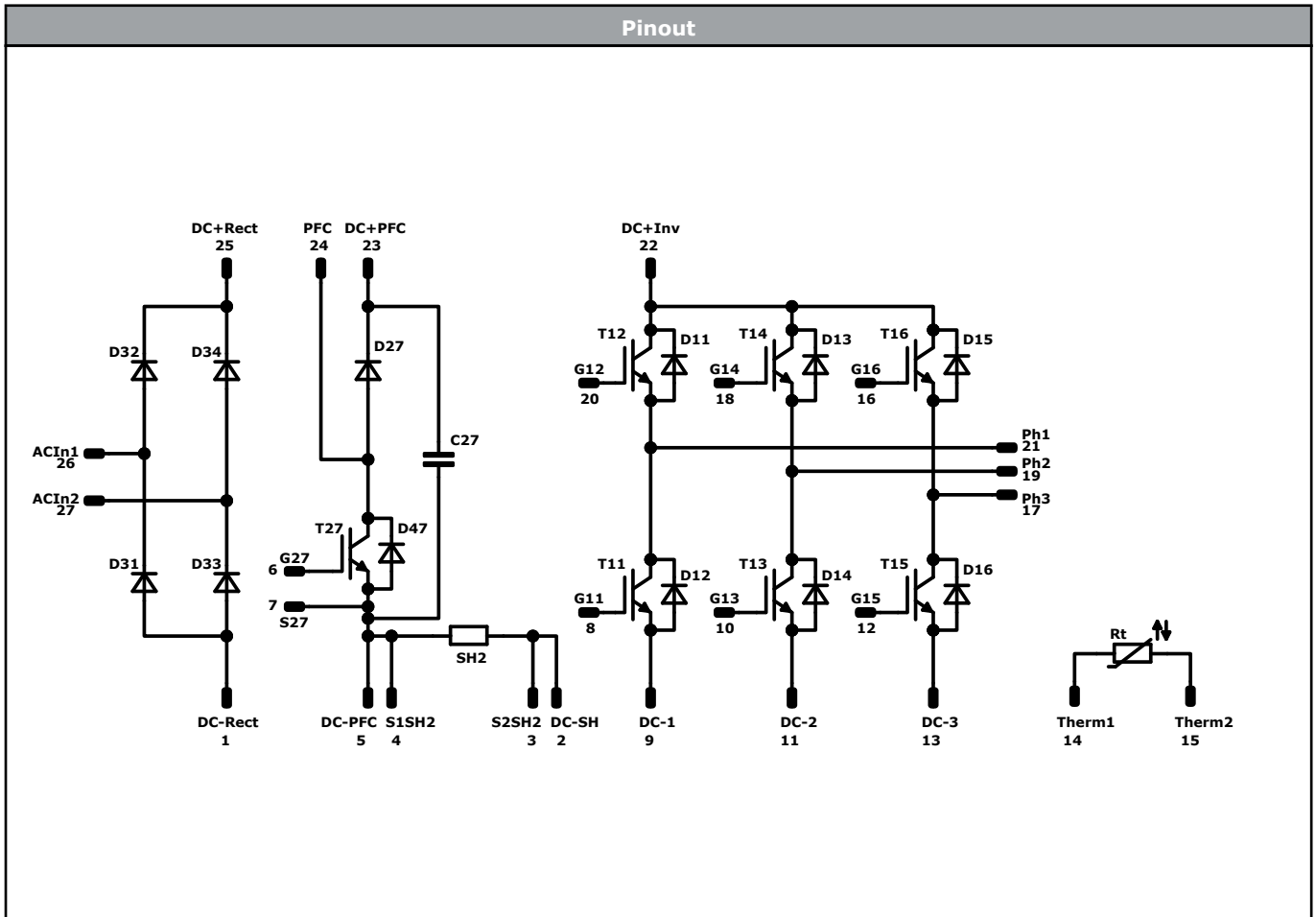

Identification					
ID	Component	Voltage	Current	Function	Comment
D47	FWD	650 V	20 A	PFC Sw. Inverse Diode	
T11, T12, T13, T14, T15, T16	IGBT	650 V	20 A	Inverter Switch	
D11, D12, D13, D14, D15, D16	FWD	650 V	20 A	Inverter Diode	
T27	IGBT	650 V	40 A	PFC Switch	
D27	FWD	600 V	60 A	PFC Diode	
D31, D32, D33, D34	Rectifier	1600 V	28 A	Rectifier Diode	
SH2	Shunt			PFC Shunt	
C27	Capacitor	630 V		Capacitor (PFC)	
Rt	Thermistor			Thermistor	



Packaging instruction				
Standard packaging quantity (SPQ) 135	>SPQ	Standard	<SPQ	Sample

Handling instruction
Handling instructions for <i>flow 0</i> packages see vincotech.com website.

Package data
Package data for <i>flow 0</i> packages see vincotech.com website.

Vincotech thermistor reference
See Vincotech thermistor reference table at vincotech.com website.

UL recognition and file number
This device is UL 1557 recognized under E192116 up to a junction temperature under switching condition $T_{j,op}=175^{\circ}C$ and up to 3500VAC/1min isolation voltage. For more information see vincotech.com website.



Document No.:	Date:	Modification:	Pages
10-FU07PPA020I7-M685B56-D1-14	26 Feb. 2024		

DISCLAIMER

The information, specifications, procedures, methods and recommendations herein (together "information") are presented by Vincotech to reader in good faith, are believed to be accurate and reliable, but may well be incomplete and/or not applicable to all conditions or situations that may exist or occur. Vincotech reserves the right to make any changes without further notice to any products to improve reliability, function or design. No representation, guarantee or warranty is made to reader as to the accuracy, reliability or completeness of said information or that the application or use of any of the same will avoid hazards, accidents, losses, damages or injury of any kind to persons or property or that the same will not infringe third parties rights or give desired results. It is reader's sole responsibility to test and determine the suitability of the information and the product for reader's intended use.

LIFE SUPPORT POLICY

Vincotech products are not authorised for use as critical components in life support devices or systems without the express written approval of Vincotech.

As used herein:

1. Life support devices or systems are devices or systems which, (a) are intended for surgical implant into the body, or (b) support or sustain life, or (c) whose failure to perform when properly used in accordance with instructions for use provided in labelling can be reasonably expected to result in significant injury to the user.
2. A critical component is any component of a life support device or system whose failure to perform can be reasonably expected to cause the failure of the life support device or system, or to affect its safety or effectiveness.