



**flowBOOST 1 symmetric dual**

**1200 V / 75 A**

**Features**

- Symmetric Boost for 1500Vdc applications
- Latest IGBT technology for high speed frequencies
- Low inductance package
- Integrated NTC
- Cost effective alternative to L869L08
- Same package and pin-out as L869L08

**Target applications**

- Solar Inverters

**Types**

- 10-FY12S2A075SH-L860L48

**flow 1 12 mm housing**

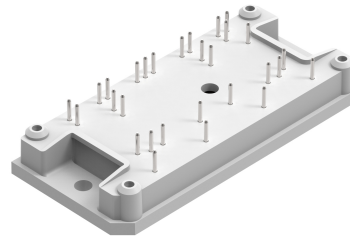

**Schematic**

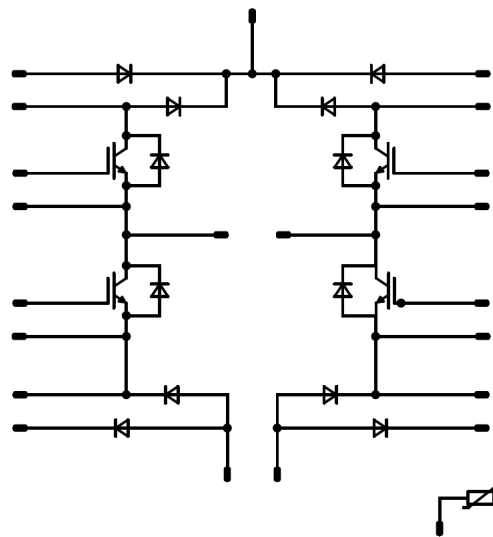



Vincotech

**10-FY12S2A075SH-L860L48**  
datasheet

## Maximum Ratings

$T_j = 25\text{ °C}$ , unless otherwise specified

Parameter	Symbol	Conditions	Value	Unit
<b>Boost Switch</b>				
Collector-emitter voltage	$V_{CES}$		1200	V
Collector current (DC current)	$I_C$	$T_j = T_{jmax}$ $T_s = 80\text{ °C}$	60	A
Repetitive peak collector current	$I_{CRM}$	$t_p$ limited by $T_{jmax}$	225	A
Total power dissipation	$P_{tot}$	$T_j = T_{jmax}$ $T_s = 80\text{ °C}$	141	W
Gate-emitter voltage	$V_{GES}$		$\pm 20$	V
Short circuit ratings	$t_{SC}$	$V_{GE} = 15\text{ V}$ , $V_{CC} = 800\text{ V}$ $T_j = 150\text{ °C}$	10	$\mu\text{s}$
Maximum junction temperature	$T_{jmax}$		175	$^{\circ}\text{C}$

## Boost Diode

Peak repetitive reverse voltage	$V_{RRM}$		1200	V
Forward current (DC current)	$I_F$	$T_j = T_{jmax}$ $T_s = 80\text{ °C}$	33	A
Repetitive peak forward current	$I_{FRM}$	$t_p$ limited by $T_{jmax}$	92	A
Surge (non-repetitive) forward current	$I_{FSM}$	Single Half Sine Wave, $t_p = 8,3\text{ ms}$ $T_j = 150\text{ °C}$	66	A
Total power dissipation	$P_{tot}$	$T_j = T_{jmax}$ $T_s = 80\text{ °C}$	87	W
Maximum junction temperature	$T_{jmax}$		175	$^{\circ}\text{C}$

## Boost Sw. Protection Diode

Peak repetitive reverse voltage	$V_{RRM}$		1600	V
Forward current (DC current)	$I_F$	$T_j = T_{jmax}$ $T_s = 80\text{ °C}$	31	A
Surge (non-repetitive) forward current	$I_{FSM}$	Single Half Sine Wave, $t_p = 10\text{ ms}$ $T_j = 150\text{ °C}$	200	A
Surge current capability	$I^2t$		200	$\text{A}^2\text{s}$
Total power dissipation	$P_{tot}$	$T_j = T_{jmax}$ $T_s = 80\text{ °C}$	37	W
Maximum junction temperature	$T_{jmax}$		150	$^{\circ}\text{C}$



Vincotech

## Maximum Ratings

$T_j = 25\text{ °C}$ , unless otherwise specified

Parameter	Symbol	Conditions	Value	Unit
<b>ByPass Diode</b>				
Peak repetitive reverse voltage	$V_{RRM}$		1600	V
Forward current (DC current)	$I_F$	$T_j = T_{jmax}$ $T_s = 80\text{ °C}$	38	A
Surge (non-repetitive) forward current	$I_{FSM}$	Single Half Sine Wave, $t_p = 10\text{ ms}$ $T_j = 150\text{ °C}$	270	A
Surge current capability	$I^2t$		370	A <sup>2</sup> s
Total power dissipation	$P_{tot}$	$T_j = T_{jmax}$ $T_s = 80\text{ °C}$	47	W
Maximum junction temperature	$T_{jmax}$		150	°C

## Module Properties

### Thermal Properties

Storage temperature	$T_{stg}$		-40...+125	°C
Operation temperature under switching condition	$T_{jop}$		-40...+( $T_{jmax} - 25$ )	°C

### Isolation Properties

Isolation voltage	$V_{isol}$	DC Test Voltage* $t_p = 2\text{ s}$	6000	V
Isolation voltage	$V_{isol}$	AC Voltage $t_p = 1\text{ min}$	2500	V
Creepage distance			>12,7	mm
Clearance			9,6	mm
Comparative Tracking Index	CTI		≥ 200	

\*100 % tested in production



Vincotech

### Characteristic Values

Parameter	Symbol	Conditions					Values			Unit
		$V_{GE}$ [V] $V_{GS}$ [V]	$V_{CE}$ [V] $V_{DS}$ [V] $V_F$ [V]	$I_C$ [A] $I_D$ [A] $I_F$ [A]	$T_j$ [°C]	Min	Typ	Max		

#### Boost Switch

##### Static

Gate-emitter threshold voltage	$V_{GE(th)}$	$V_{CE} = V_{GE}$			0,0026	25	5,3	5,8	6,3	V
Collector-emitter saturation voltage	$V_{CE(sat)}$		15		75	25 125 150	1,78	2,16 2,48	2,42 <sup>(1)</sup>	V
Collector-emitter cut-off current	$I_{CES}$		0	1200		25			1	μA
Gate-emitter leakage current	$I_{GES}$		20	0		25			120	nA
Internal gate resistance	$r_g$							None		Ω
Input capacitance	$C_{ies}$	$f = 1 \text{ Mhz}$	0	25		25		4400		pF
Reverse transfer capacitance	$C_{res}$							235		pF
Gate charge	$Q_g$		15		0	25		570		nC

##### Thermal

Thermal resistance junction to sink <sup>(2)</sup>	$R_{th(j-s)}$	$\lambda_{paste} = 3,4 \text{ W/mK}$ (PSX)						0,68		K/W
--	---------------	---	--	--	--	--	--	------	--	-----

##### Dynamic

Turn-on delay time	$t_{d(on)}$	$R_{gon} = 4 \Omega$ $R_{goff} = 4 \Omega$	0/15	700	45	25		16,5		ns
Rise time	$t_r$					125		15,5		
						150		14,5		
						25		13,5		
Turn-off delay time	$t_{d(off)}$					125		15		
						150		15		
						25		234,5		
Fall time	$t_f$					125		309		
		150		326,5						
		25		20,1						
Turn-on energy (per pulse)	$E_{on}$	$Q_{tFWD} = 0,383 \mu\text{C}$				25		1,06		mWs
		$Q_{tFWD} = 0,491 \mu\text{C}$				125		1,15		
		$Q_{tFWD} = 0,434 \mu\text{C}$				150		1,21		
Turn-off energy (per pulse)	$E_{off}$					25		1,86		mWs
						125		3,34		
						150		3,72		



Vincotech

10-FY12S2A075SH-L860L48  
datasheet

### Characteristic Values

Parameter	Symbol	Conditions					Values			Unit
		$V_{GE}$ [V] $V_{GS}$ [V]	$V_{CE}$ [V] $V_{DS}$ [V] $V_F$ [V]	$I_C$ [A] $I_D$ [A] $I_F$ [A]	$T_j$ [°C]	Min	Typ	Max		
<b>Boost Diode</b>										
<b>Static</b>										
Forward voltage	$V_F$				20	25 125 150		1,43 1,74 1,85	1,6 <sup>(1)</sup>	V
Reverse leakage current	$I_R$	$V_r = 1200$ V				25 150		20 160	400	μA
<b>Thermal</b>										
Thermal resistance junction to sink <sup>(2)</sup>	$R_{th(j-s)}$	$\lambda_{paste} = 3,4$ W/mK (PSX)						1,09		K/W
<b>Dynamic</b>										
Peak recovery current	$I_{RRM}$					25 125 150		17,17 19,4 19,99		A
Reverse recovery time	$t_{rr}$					25 125 150		10,26 10,44 10,5		ns
Recovered charge	$Q_r$	$di/dt=3340$ A/μs $di/dt=3517$ A/μs $di/dt=3726$ A/μs	0/15	700	45	25 125 150		0,383 0,491 0,434		μC
Reverse recovered energy	$E_{rec}$					25 125 150		0,176 0,237 0,199		mWs
Peak rate of fall of recovery current	$(di_r/dt)_{max}$					25 125 150		5147 5555 6124		A/μs



Vincotech

### Characteristic Values

Parameter	Symbol	Conditions					Values			Unit
		$V_{GE}$ [V] $V_{GS}$ [V]	$V_{CE}$ [V] $V_{DS}$ [V] $V_F$ [V]	$I_C$ [A] $I_D$ [A] $I_F$ [A]	$T_j$ [°C]	Min	Typ	Max		

#### Boost Sw. Protection Diode

##### Static

Forward voltage	$V_F$				18	25 125 150		1,11 1,03 1,02	1,5 <sup>(1)</sup>	V
Reverse leakage current	$I_R$	$V_r = 1600$ V				25 150			100 1000	μA

##### Thermal

Thermal resistance junction to sink <sup>(2)</sup>	$R_{th(j-s)}$	$\lambda_{paste} = 3,4$ W/mK (PSX)						1,87		K/W
--	---------------	------------------------------------	--	--	--	--	--	------	--	-----

#### ByPass Diode

##### Static

Forward voltage	$V_F$				28	25 125		1,15 1,1	1,5 <sup>(1)</sup>	V
Reverse leakage current	$I_R$	$V_r = 1600$ V				25 150			100 1000	μA

##### Thermal

Thermal resistance junction to sink <sup>(2)</sup>	$R_{th(j-s)}$	$\lambda_{paste} = 3,4$ W/mK (PSX)						1,5		K/W
--	---------------	------------------------------------	--	--	--	--	--	-----	--	-----



Vincotech

### Characteristic Values

Parameter	Symbol	Conditions					Values			Unit
		$V_{GS}$ [V]	$V_{GE}$ [V]	$V_{DS}$ [V]	$V_{CE}$ [V]	$T_j$ [°C]	Min	Typ	Max	

### Thermistor

#### Static

Rated resistance	$R$					25		22		kΩ
Deviation of $R_{100}$	$A_{R/R}$	$R_{100} = 1484 \Omega$				100	-5		5	%
Power dissipation	$P$							5		mW
Power dissipation constant	$d$					25		1,5		mW/K
B-value	$B_{(25/50)}$	Tol. $\pm 1 \%$						3962		K
B-value	$B_{(25/100)}$	Tol. $\pm 1 \%$						4000		K
Vincotech Thermistor Reference									I	

<sup>(1)</sup> Value at chip level

<sup>(2)</sup> Only valid with pre-applied Vincotech thermal interface material.



### Boost Switch Characteristics

**figure 1.** IGBT

Typical output characteristics

$$I_C = f(V_{CE})$$

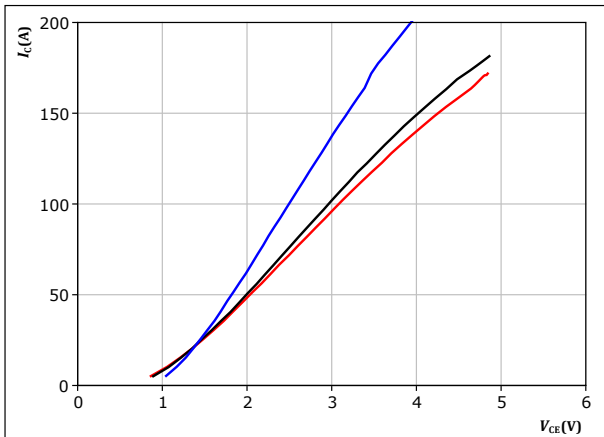

$t_p = 250 \mu s$   
 $V_{GE} = 15 V$   
 $T_j:$  25 °C, 125 °C, 150 °C

**figure 2.** IGBT

Typical output characteristics

$$I_C = f(V_{CE})$$

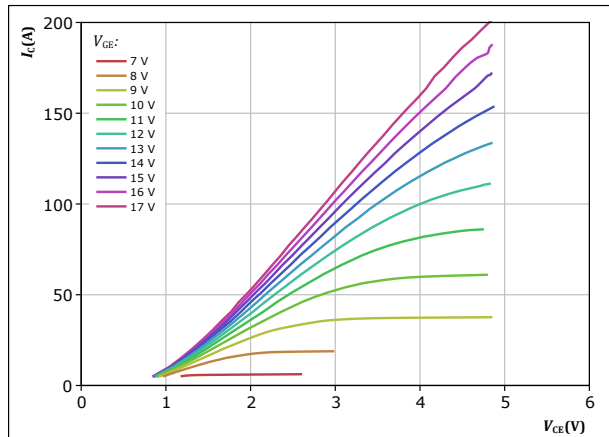

$t_p = 250 \mu s$   
 $T_j = 150 \text{ °C}$   
 $V_{GE}$  from 7 V to 17 V in steps of 1 V

**figure 3.** IGBT

Typical transfer characteristics

$$I_C = f(V_{GE})$$

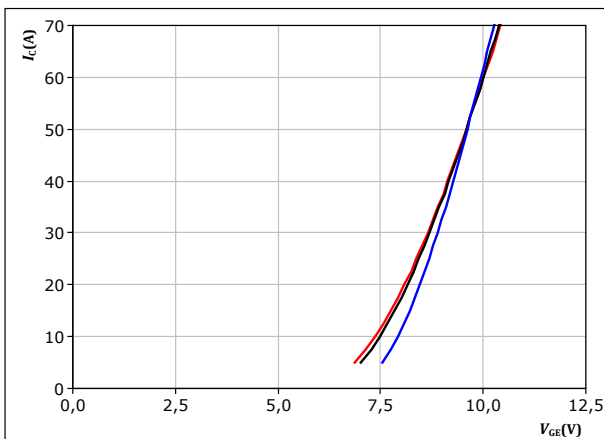

$t_p = 250 \mu s$   
 $V_{CE} = 10 V$   
 $T_j:$  25 °C, 125 °C, 150 °C

**figure 4.** IGBT

Transient thermal impedance as a function of pulse width

$$Z_{th(j-s)} = f(t_p)$$

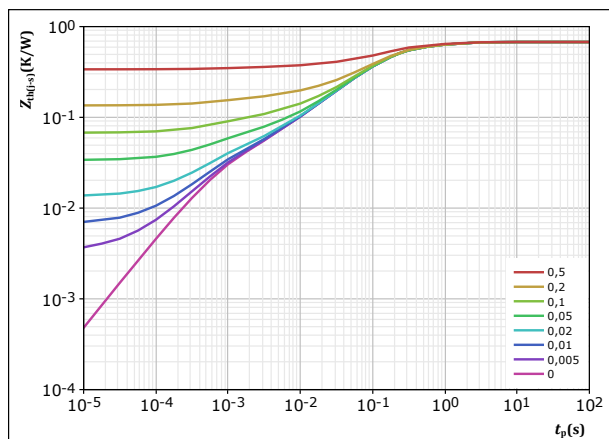

$D = t_p / T$   
 $R_{th(j-s)} = 0,676 \text{ K/W}$   
IGBT thermal model values  

$R$ (K/W)	$\tau$ (s)
1,22E-01	9,44E-01
3,87E-01	1,41E-01
9,93E-02	4,84E-02
3,95E-02	8,56E-03
2,86E-02	7,39E-04





### Boost Switch Characteristics

figure 5. IGBT

Safe operating area

$$I_C = f(V_{CE})$$

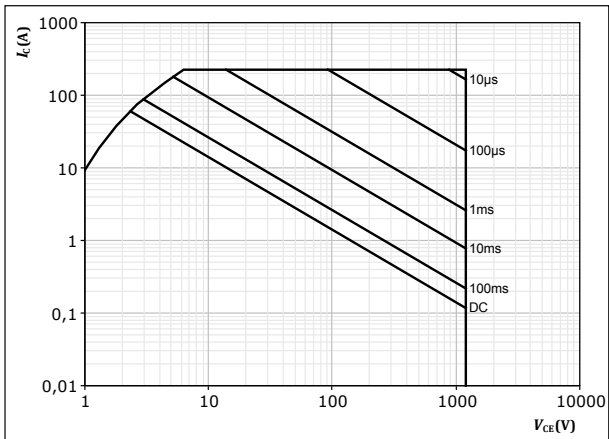

$D =$  single pulse  
 $T_s = 80 \text{ } ^\circ\text{C}$   
 $V_{GE} = 15 \text{ V}$   
 $T_j = T_{jmax}$



### Boost Diode Characteristics

figure 6. FWD

Typical forward characteristics

$$I_F = f(V_F)$$

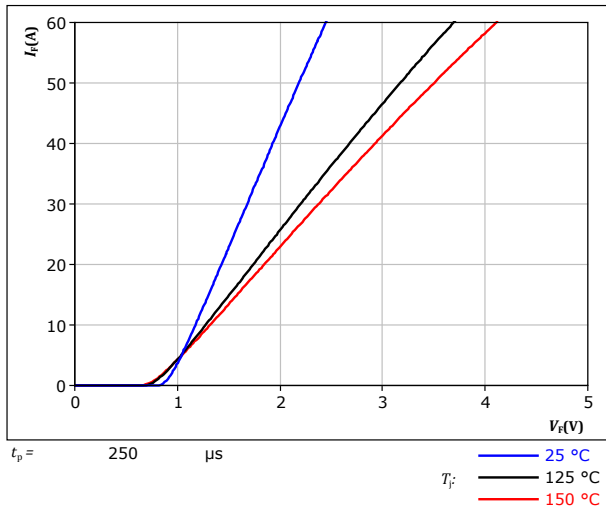
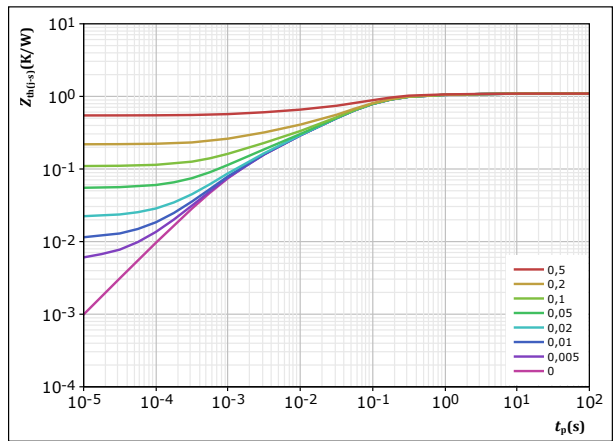

figure 7. FWD

Transient thermal impedance as a function of pulse width

$$Z_{th(j-s)} = f(t_p)$$



$D = t_p / T$   
 $R_{th(j-s)} = 1,093 \text{ K/W}$   
 FWD thermal model values

R (K/W)	$\tau$ (s)
4,73E-02	2,96E+00
1,05E-01	4,20E-01
5,77E-01	8,31E-02
1,79E-01	2,65E-02
1,16E-01	5,49E-03
6,86E-02	1,07E-03



## Boost Sw. Protection Diode Characteristics

figure 8. Rectifier

Typical forward characteristics

$$I_F = f(V_F)$$

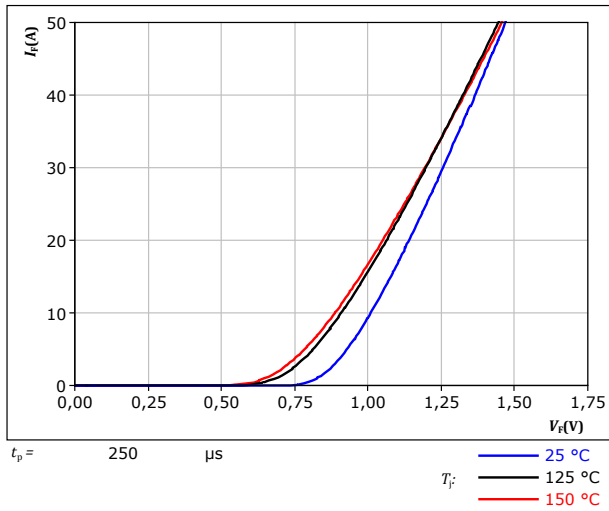
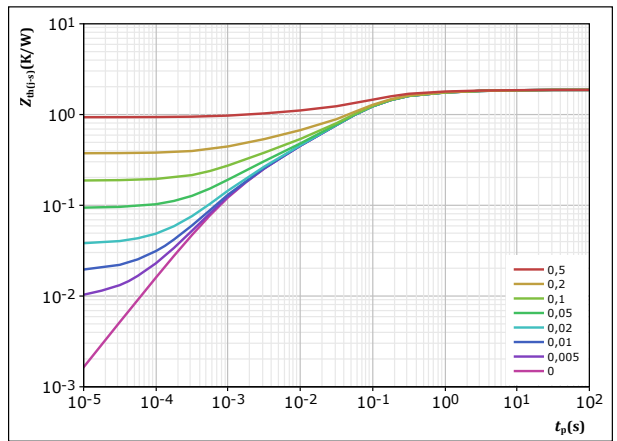

figure 9. Rectifier

Transient thermal impedance as a function of pulse width

$$Z_{th(j-s)} = f(t_p)$$



$D =$   $t_p / T$   
 $R_{th(j-s)} = 1,869$  K/W  
 Rectifier thermal model values

$R$ (K/W)	$\tau$ (s)
5,65E-02	8,90E+00
1,70E-01	1,08E+00
6,15E-01	1,58E-01
6,94E-01	5,21E-02
2,16E-01	6,16E-03
1,19E-01	1,06E-03



### ByPass Diode Characteristics

**figure 10.** Rectifier

Typical forward characteristics

$$I_F = f(V_F)$$

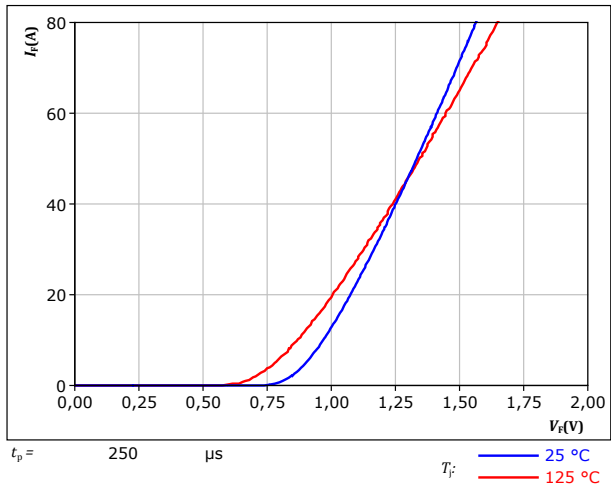

**figure 11.** Rectifier

Transient thermal impedance as a function of pulse width

$$Z_{th(j-s)} = f(t_p)$$

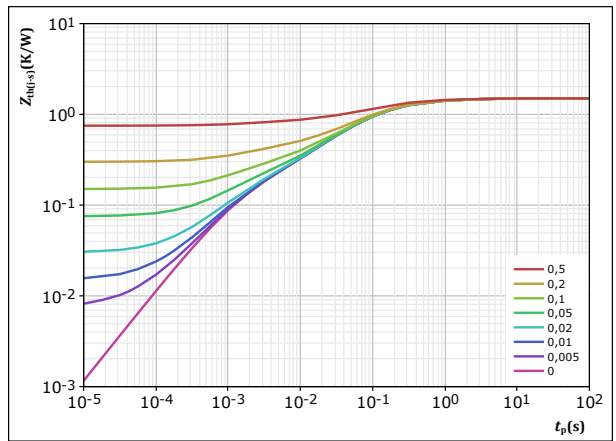

$D = t_p / T$   
 $R_{th(j-s)} = 1,5 \text{ K/W}$   
 Rectifier thermal model values

R (K/W)	$\tau$ (s)
9,44E-02	2,48E+00
3,47E-01	3,51E-01
7,44E-01	7,63E-02
2,04E-01	1,21E-02
1,11E-01	1,25E-03



## Thermistor Characteristics

figure 12. Thermistor

Typical NTC characteristic as function of temperature

$$R_T = f(T)$$

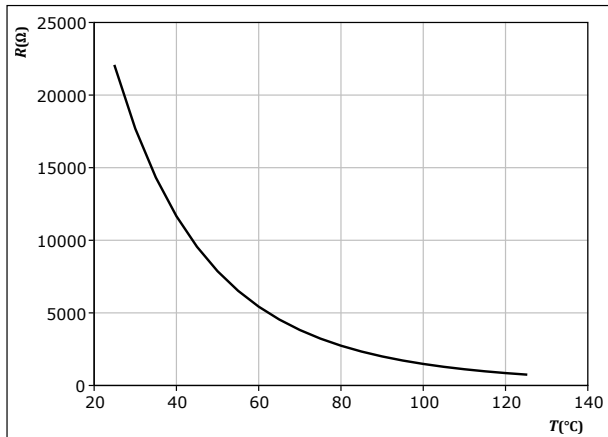



## Boost Switching Characteristics

**figure 13.** IGBT

Typical switching energy losses as a function of collector current  
 $E = f(I_c)$

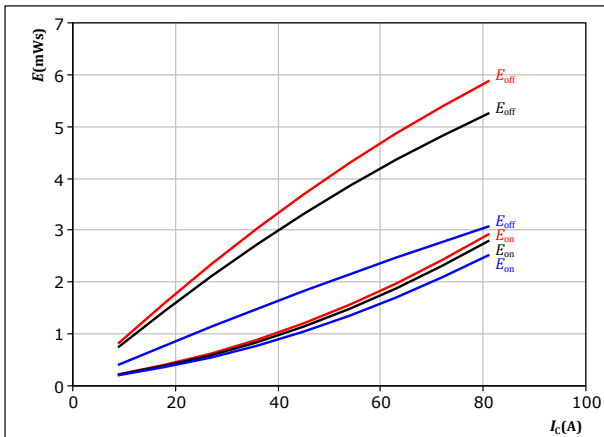

With an inductive load at

$V_{CE} = 700 \text{ V}$   
 $V_{GE} = 0/15 \text{ V}$   
 $R_{gon} = 4 \ \Omega$   
 $R_{goff} = 4 \ \Omega$

$T_j$ : — 25 °C  
— 125 °C  
— 150 °C

**figure 14.** IGBT

Typical switching energy losses as a function of gate resistor  
 $E = f(R_g)$

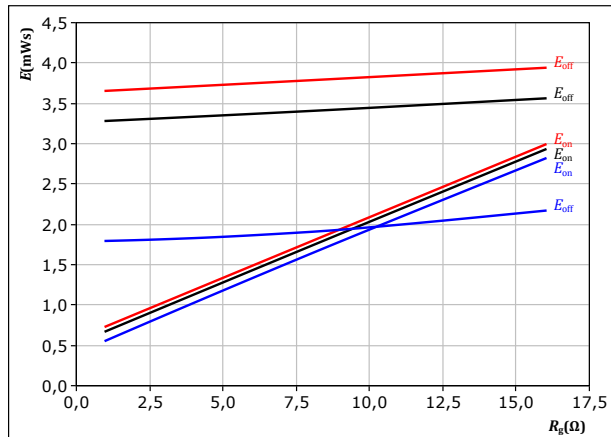

With an inductive load at

$V_{CE} = 700 \text{ V}$   
 $V_{GE} = 0/15 \text{ V}$   
 $I_c = 45 \text{ A}$

$T_j$ : — 25 °C  
— 125 °C  
— 150 °C

**figure 15.** FWD

Typical reverse recovered energy loss as a function of collector current  
 $E_{rec} = f(I_c)$

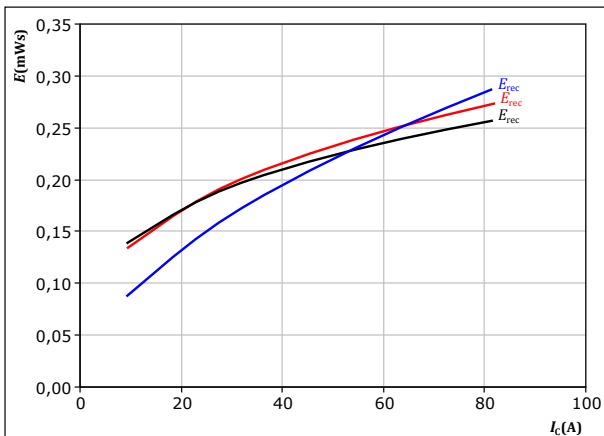

With an inductive load at

$V_{CE} = 700 \text{ V}$   
 $V_{GE} = 0/15 \text{ V}$   
 $R_{gon} = 4 \ \Omega$

$T_j$ : — 25 °C  
— 125 °C  
— 150 °C

**figure 16.** FWD

Typical reverse recovered energy loss as a function of gate resistor  
 $E_{rec} = f(R_g)$

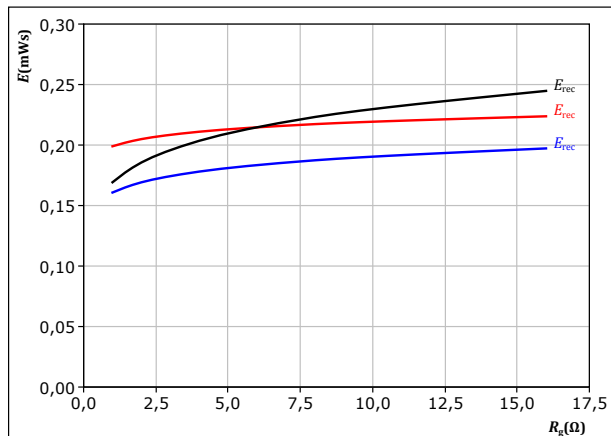

With an inductive load at

$V_{CE} = 700 \text{ V}$   
 $V_{GE} = 0/15 \text{ V}$   
 $I_c = 45 \text{ A}$

$T_j$ : — 25 °C  
— 125 °C  
— 150 °C



## Boost Switching Characteristics

**figure 17.** IGBT

Typical switching times as a function of collector current  
 $t = f(I_c)$

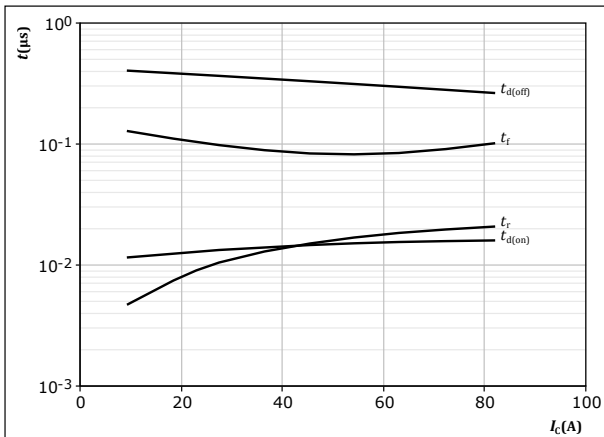

With an inductive load at  
 $T_j = 150 \text{ }^\circ\text{C}$   
 $V_{CE} = 700 \text{ V}$   
 $V_{GE} = 0/15 \text{ V}$   
 $R_{g(on)} = 4 \text{ } \Omega$   
 $R_{g(off)} = 4 \text{ } \Omega$

**figure 18.** IGBT

Typical switching times as a function of gate resistor  
 $t = f(R_g)$

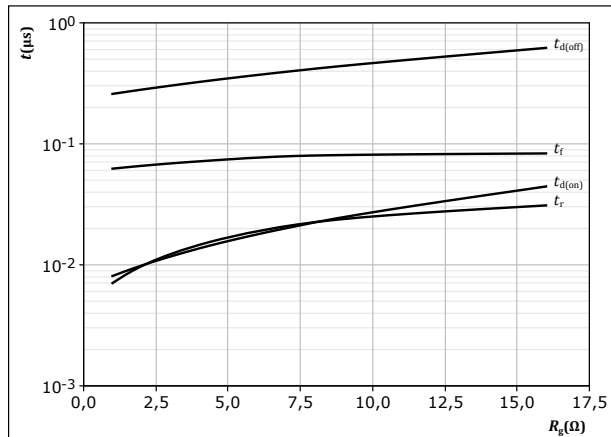

With an inductive load at  
 $T_j = 150 \text{ }^\circ\text{C}$   
 $V_{CE} = 700 \text{ V}$   
 $V_{GE} = 0/15 \text{ V}$   
 $I_c = 45 \text{ A}$

**figure 19.** FWD

Typical reverse recovery time as a function of collector current  
 $t_{rr} = f(I_c)$

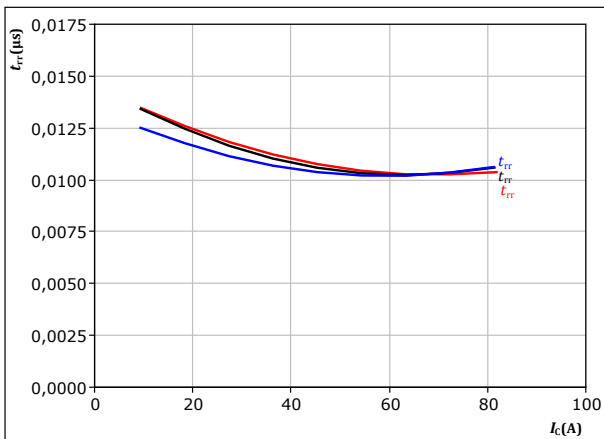

With an inductive load at  
 $V_{CE} = 700 \text{ V}$   
 $V_{GE} = 0/15 \text{ V}$   
 $R_{g(on)} = 4 \text{ } \Omega$   
 $T_j: \text{ } \text{---} 25 \text{ }^\circ\text{C}$   
 $\text{---} 125 \text{ }^\circ\text{C}$   
 $\text{---} 150 \text{ }^\circ\text{C}$

**figure 20.** FWD

Typical reverse recovery time as a function of IGBT turn off gate resistor  
 $t_{rr} = f(R_{g(off)})$

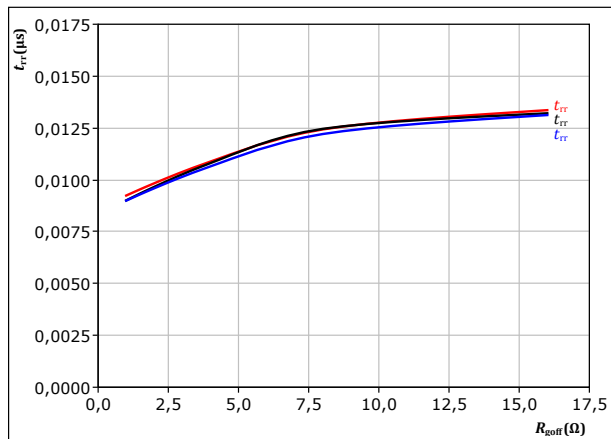

With an inductive load at  
 $V_{CE} = 700 \text{ V}$   
 $V_{GE} = 0/15 \text{ V}$   
 $I_c = 45 \text{ A}$   
 $T_j: \text{ } \text{---} 25 \text{ }^\circ\text{C}$   
 $\text{---} 125 \text{ }^\circ\text{C}$   
 $\text{---} 150 \text{ }^\circ\text{C}$



## Boost Switching Characteristics

figure 21. FWD

Typical recovered charge as a function of collector current

$$Q_r = f(I_c)$$

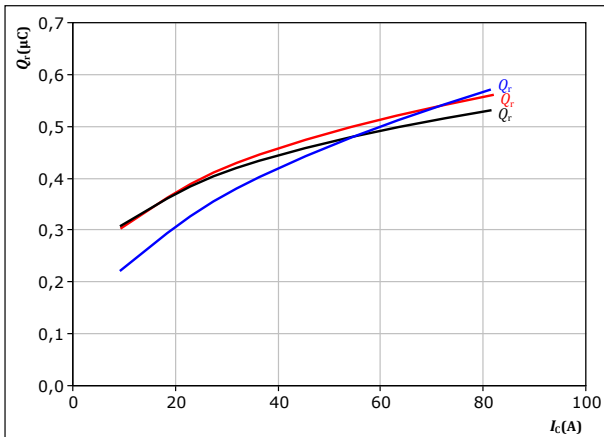

With an inductive load at

$V_{CE} = 700 \text{ V}$   
 $V_{GE} = 0/15 \text{ V}$   
 $R_{goff} = 4 \text{ } \Omega$

$T_j$ : — 25 °C  
— 125 °C  
— 150 °C

figure 22. FWD

Typical recovered charge as a function of turn off gate resistor

$$Q_r = f(R_{goff})$$

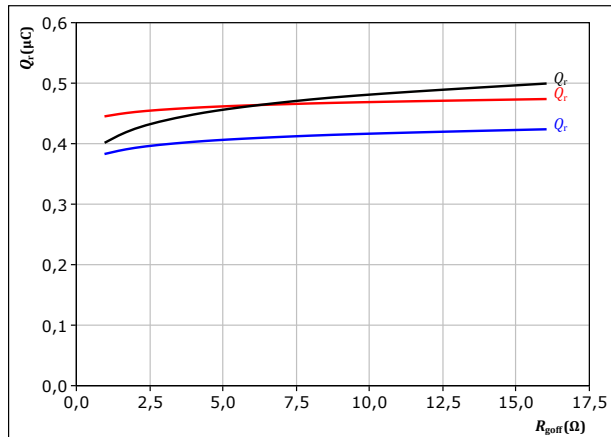

With an inductive load at

$V_{CE} = 700 \text{ V}$   
 $V_{GE} = 0/15 \text{ V}$   
 $I_c = 45 \text{ A}$

$T_j$ : — 25 °C  
— 125 °C  
— 150 °C

figure 23. FWD

Typical peak reverse recovery current as a function of collector current

$$I_{RM} = f(I_c)$$

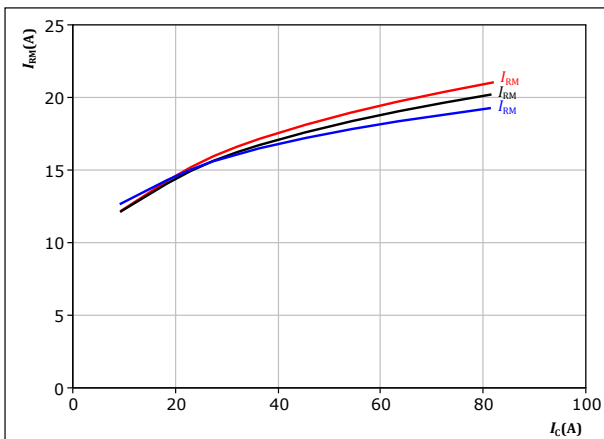

With an inductive load at

$V_{CE} = 700 \text{ V}$   
 $V_{GE} = 0/15 \text{ V}$   
 $R_{goff} = 4 \text{ } \Omega$

$T_j$ : — 25 °C  
— 125 °C  
— 150 °C

figure 24. FWD

Typical peak reverse recovery current as a function of turn off gate resistor

$$I_{RM} = f(R_{goff})$$

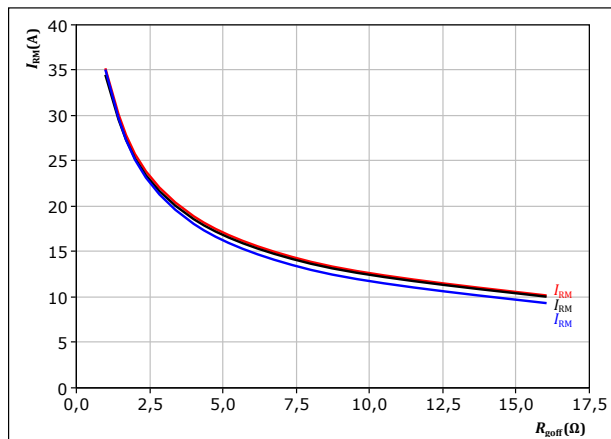

With an inductive load at

$V_{CE} = 700 \text{ V}$   
 $V_{GE} = 0/15 \text{ V}$   
 $I_c = 45 \text{ A}$

$T_j$ : — 25 °C  
— 125 °C  
— 150 °C





## Boost Switching Characteristics

**figure 25.** FWD

Typical rate of fall of forward and reverse recovery current as a function of collector current  
 $di_f/dt, di_r/dt = f(I_c)$

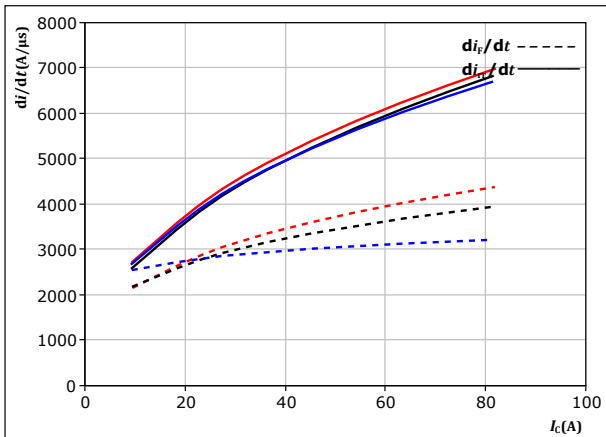

With an inductive load at

$V_{CE} = 700 \text{ V}$   
 $V_{GE} = 0/15 \text{ V}$   
 $R_{goff} = 4 \text{ } \Omega$

$T_j$ :  
— 25 °C  
— 125 °C  
— 150 °C

**figure 26.** FWD

Typical rate of fall of forward and reverse recovery current as a function of turn off gate resistor  
 $di_f/dt, di_r/dt = f(R_{goff})$

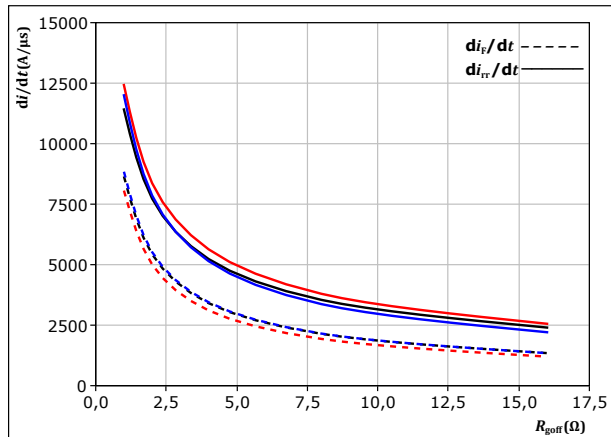

With an inductive load at

$V_{CE} = 700 \text{ V}$   
 $V_{GE} = 0/15 \text{ V}$   
 $I_c = 45 \text{ A}$

$T_j$ :  
— 25 °C  
— 125 °C  
— 150 °C

**figure 27.** IGBT

Reverse bias safe operating area

$I_c = f(V_{CE})$

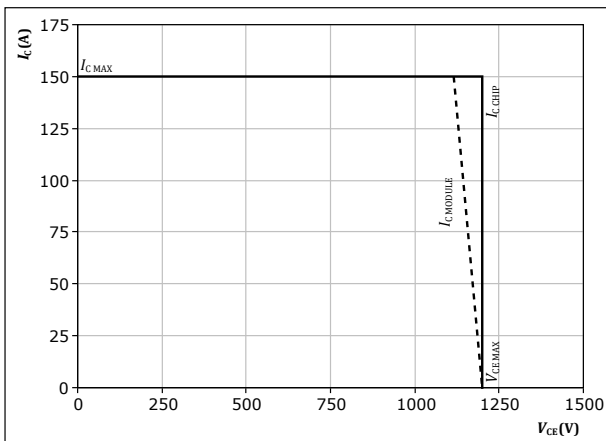

At  $T_j = 150 \text{ } ^\circ\text{C}$   
 $R_{goff} = 4 \text{ } \Omega$   
 $R_{goff} = 4 \text{ } \Omega$



## Boost Switching Definitions

figure 28. IGBT

Turn-off Switching Waveforms & definition of  $t_{doff}$ ,  $t_{Eoff}$  ( $t_{Eoff}$  = integrating time for  $E_{off}$ )

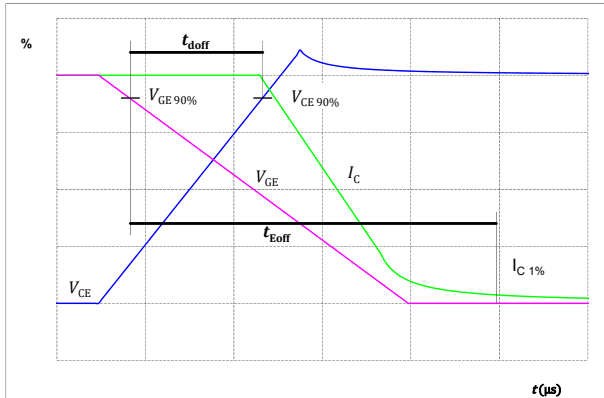

figure 29. IGBT

Turn-on Switching Waveforms & definition of  $t_{don}$ ,  $t_{Eon}$  ( $t_{Eon}$  = integrating time for  $E_{on}$ )

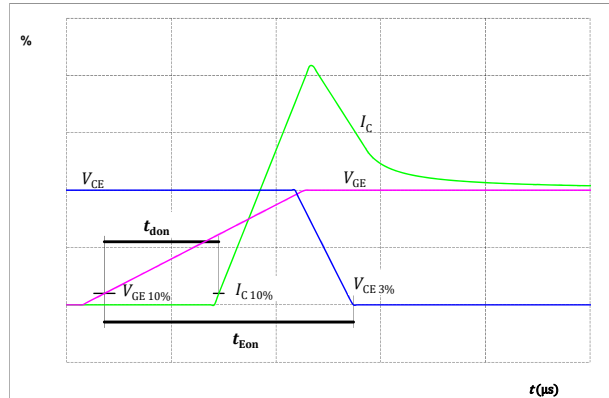

figure 30. IGBT

Turn-off Switching Waveforms & definition of  $t_f$

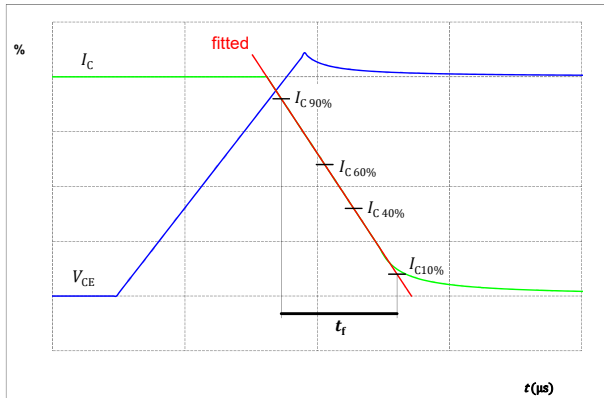
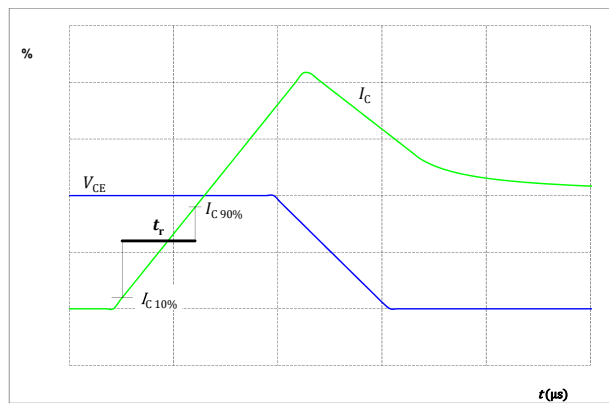

figure 31. IGBT

Turn-on Switching Waveforms & definition of  $t_r$





### Boost Switching Definitions

figure 32. FWD

Turn-off Switching Waveforms & definition of  $t_{rr}$

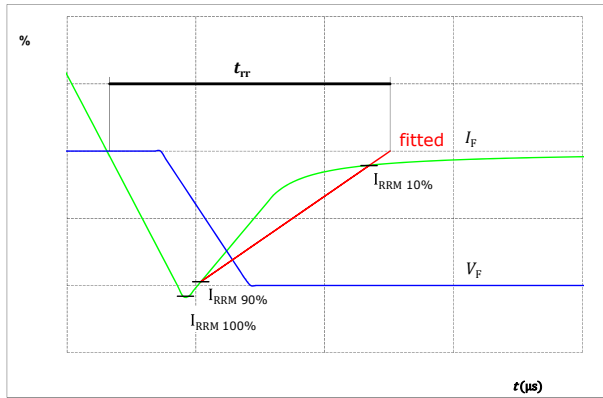
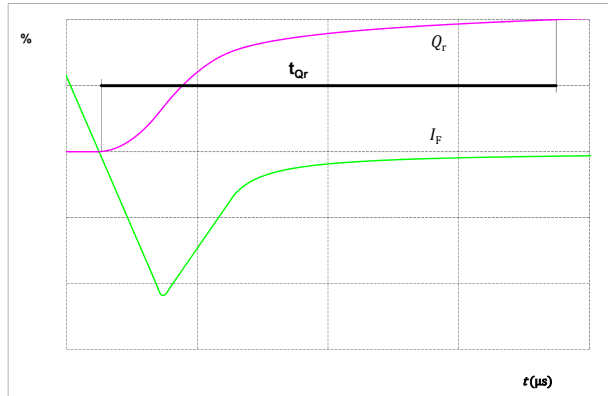

figure 33. FWD

Turn-on Switching Waveforms & definition of  $t_{Qr}$  ( $t_{Qr}$  = integrating time for  $Q_r$ )





Vincotech

# 10-FY12S2A075SH-L860L48

datasheet

Ordering Code	
<b>Version</b>	<b>Ordering Code</b>
Without thermal paste	10-FY12S2A075SH-L860L48
With thermal paste (5,2 W/mK, PTM6000HV)	10-FY12S2A075SH-L860L48-/7/
With thermal paste (3,4 W/mK, PSX-P7)	10-FY12S2A075SH-L860L48-/3/

Marking						
	<b>Text</b>	<b>Name</b> NN-NNNNNNNNNNNNNN- TTTTIVV	<b>Date code</b> WWYY	<b>UL &amp; VIN</b> UL VIN	<b>Lot</b> LLLLL	<b>Serial</b> SSSS
	<b>Datamatrix</b>	<b>Type&amp;Ver</b> TTTTIVV	<b>Lot number</b> LLLLL	<b>Serial</b> SSSS	<b>Date code</b> WWYY	

## Outline

Pin table [mm]			
Pin	X	Y	Function
1	52,5	0	DC-In2
2	50,6	7,6	S25
3	47,6	6,2	G25
4	43,8	6,2	Boost-2
5	35,9	0	DC+In2
6	31,3	6,5	Boost+2
7	21,2	6,5	Boost+1
8	16,6	0	DC+In1
9	8,7	6,2	Boost-1
10	4,9	6,2	G15
11	1,9	7,6	S15
12	0	0	DC-In1
13	10,1	21	G17
14	10,1	24	S17
15	0	25,8	DC-Boost1
16	0	28,5	DC-Boost1
17	9,7	28,5	N1
18	12,4	28,5	N1
19	22,1	28,5	DC+Boost
20	24,8	28,5	DC+Boost
21	27,5	28,5	DC+Boost
22	37,1	28,5	N2
23	39,8	28,5	N2
24	39,4	24	S27
25	39,4	21	G27
26	49,5	28,5	DC-Boost2
27	49,5	25,8	DC-Boost2
28	52,5	28,5	Therm1
29	52,5	21,3	Therm2

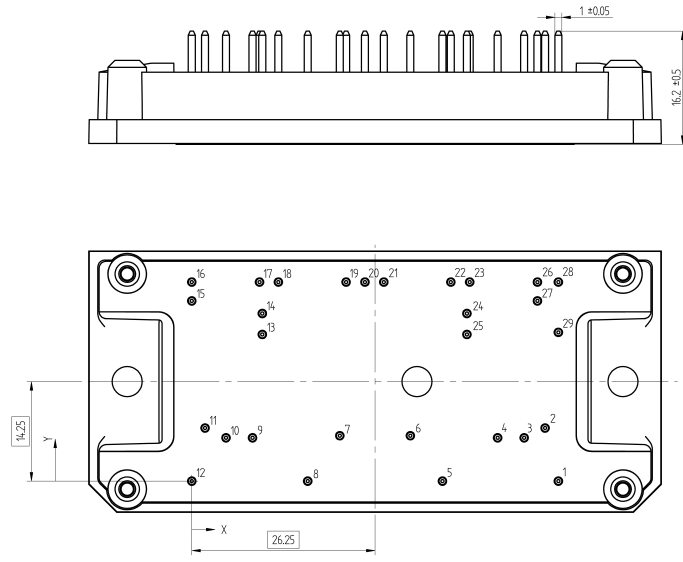

Tolerance of pinpositions: ±0.05mm at the end of pins  
Dimension of coordinate axis is only offset without tolerance



Vincotech

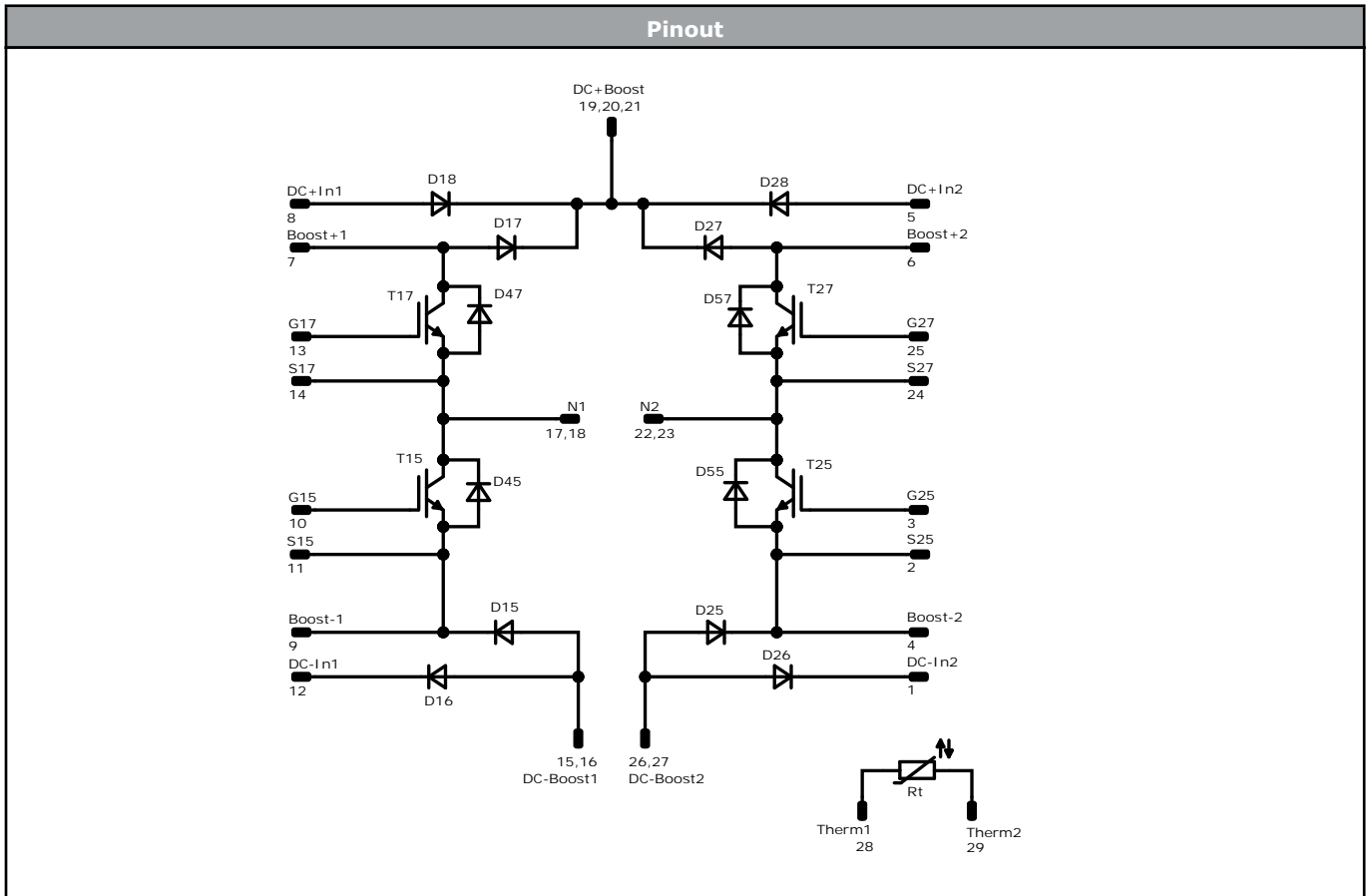

<b>Identification</b>					
<b>ID</b>	<b>Component</b>	<b>Voltage</b>	<b>Current</b>	<b>Function</b>	<b>Comment</b>
T15, T17, T25, T27	IGBT	1200 V	75 A	Boost Switch	
D15, D17, D25, D27	FWD	1200 V	20 A	Boost Diode	
D45, D47, D55, D57	Rectifier	1600 V	18 A	Boost Sw. Protection Diode	
D16, D18, D26, D28	Rectifier	1600 V	28 A	ByPass Diode	
Rt	Thermistor			Thermistor	



Vincotech

Packaging instruction				
Standard packaging quantity (SPQ) 100	>SPQ	Standard	<SPQ	Sample

Handling instruction
Handling instructions for <i>flow 1</i> packages see vincotech.com website.

Package data
Package data for <i>flow 1</i> packages see vincotech.com website.

Vincotech thermistor reference
See Vincotech thermistor reference table at vincotech.com website.

UL recognition and file number
This device is certified according to UL 1557 standard, UL file number E192116. For more information see vincotech.com website. 

Document No.:	Date:	Modification:	Pages
10-FY12S2A075SH-L860L48-D2-14	28 Sep. 2021	Change of Boost diode Tau times	

**DISCLAIMER**

The information, specifications, procedures, methods and recommendations herein (together "information") are presented by Vincotech to reader in good faith, are believed to be accurate and reliable, but may well be incomplete and/or not applicable to all conditions or situations that may exist or occur. Vincotech reserves the right to make any changes without further notice to any products to improve reliability, function or design. No representation, guarantee or warranty is made to reader as to the accuracy, reliability or completeness of said information or that the application or use of any of the same will avoid hazards, accidents, losses, damages or injury of any kind to persons or property or that the same will not infringe third parties rights or give desired results. It is reader's sole responsibility to test and determine the suitability of the information and the product for reader's intended use.

**LIFE SUPPORT POLICY**

Vincotech products are not authorised for use as critical components in life support devices or systems without the express written approval of Vincotech.

As used herein:

1. Life support devices or systems are devices or systems which, (a) are intended for surgical implant into the body, or (b) support or sustain life, or (c) whose failure to perform when properly used in accordance with instructions for use provided in labelling can be reasonably expected to result in significant injury to the user.
2. A critical component is any component of a life support device or system whose failure to perform can be reasonably expected to cause the failure of the life support device or system, or to affect its safety or effectiveness.