

REV.	DESCRIPTION	DRAWN	DATE
1	INITIAL RELEASE	FROS	2021/03/23

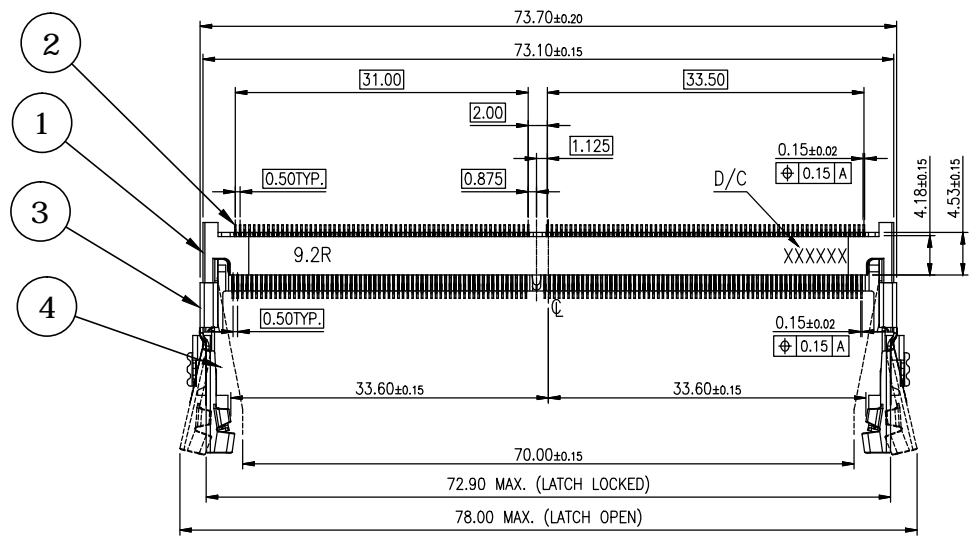

DATE CODE: YYWWD  
 YY: YEAR  
 WW: WEEK (01~52)  
 D: DAY (1~7)

**SPECIFICATION:**

1. ELECTRICAL
  - 1.1 Current Rating: 0.6A per pin
  - 1.2 Voltage Rating: 25V AC
  - 1.3 Contact Resistance: 60mΩ max.
  - 1.4 Insulation Resistance: 100MΩ
  - 1.5 Dielectric Withstanding Voltage: 500VAC
2. MECHANICAL
  - 2.1 Durability: 50 Cycle
  - 2.2 Insertion Force: 59.8N max.
  - 2.3 Extraction Force: 44.6N max.
3. ENVIRONMENTAL
  - 3.1 Operating temperature range: -40°C~+85°C
  - 3.2 Storage temperature range: -40°C~+85°C
4. SOLDER ABILITY
  - 4.1 Recommended IR-Reflow Temperature: 260°C

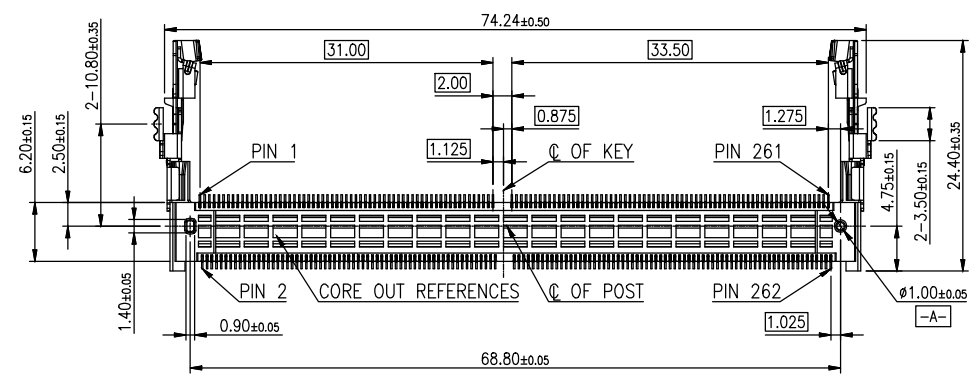
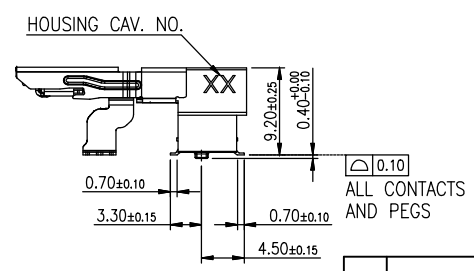
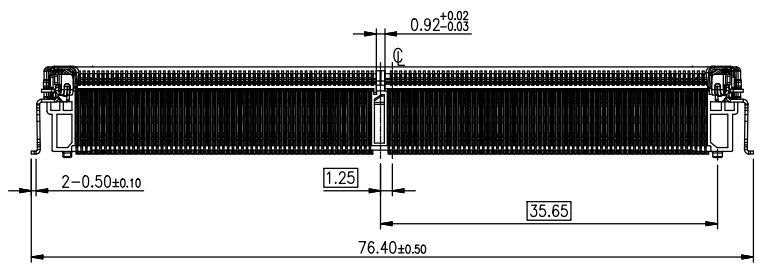

4	PEG	Stainless steel, 50u"~150u" matte tin plating over 50u"~150u" nickel plating
3	LATCH	Stainless steel
		Copper alloy, 1u" gold plating on contact and solder area, under plating nickel
2	CONTACT	
1	HOUSING	Thermoplastic, UL94V-0, Black
NO.	PART NAME	DESCRIPTION

UNLESS OTHERWISE SPECIFIED TOLERANCE

UNIT:	DECIMAL	LINEAR	ANGLES
mm	X.	±0.50	±5°
	X.X	±0.25	±3°
	X.XX	±0.12	±1°

DRAWN	Fros	2021/03/23	DRAWN NAME:	
CHECKED	Tim	2021/03/23	DDR5 SODIMM Socket, Horizontal	
APPROVED	Ken	2021/03/23	9.2H, RVS, G/F, Black, Reel, Solder PEG	
SCALE	1.25	SHEET	1/2	SIZE
				A4
FILE NAME	126A-92A10_B_1			

REV.	DESCRIPTION	DRAWN	DATE
	see sheet one		

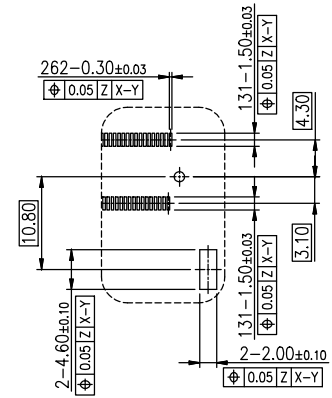
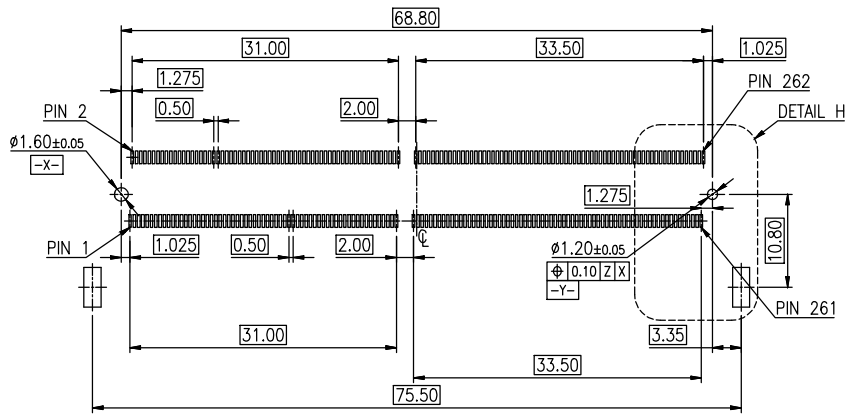

RECOMMEND P.C.BOARD LAYOUT  
 PCB THICKNESS 0.80mm MIN.  
 PCB LAYOUT GENERIC TOLERANCE:±0.05  
 ( [-Z-] :PCB SURFACE)

DETAIL H  
 SCALE 1:1

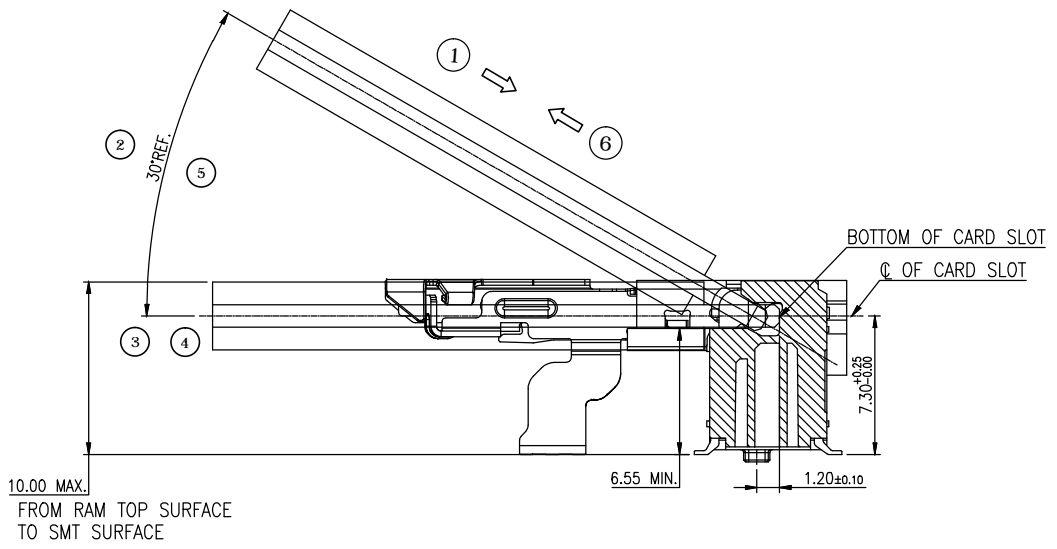

MATING: ① INSERTING → ② ROTATING → ③ FIXED  
 UNMATING: ④ UNFIXED → ⑤ RISE UP → ⑥ EXTRACTING

MATING/UNMATING VIEW

UNLESS OTHERWISE SPECIFIED TOLERANCE				
UNIT:	DECIMAL	LINEAR	ANGLES	
mm	X.	±0.50	±5°	
	X.X	±0.25	±3°	
	X.XX	±0.12	±1°	
DRAWN	Fros	2021/03/23	DRAWN NAME: DDR5 SODIMM Socket, Horizontal 9.2H, RVS, G/F, Black, Reel, Solder PEG	
CHECKED	Tim	2021/03/23		
APPROVED	Ken	2021/03/23		
SCALE	1.25	SHEET 2/2	SIZE A4	FILE NAME 126A-92A10_B_1



www.attend.com.tw

DRAWN	Fros	2021/03/23
CHECKED	Tim	2021/03/23
APPROVED	Ken	2021/03/23
PRODUCT NO.	126A-92A10	
FILE NAME	126A-92A10_B_1	

REV.	DESCRIPTION	DRAWN	DATE
1	INITIAL RELEASE	FROS	2021/03/23

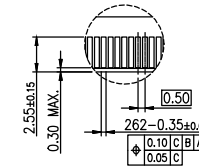
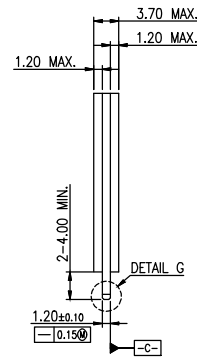
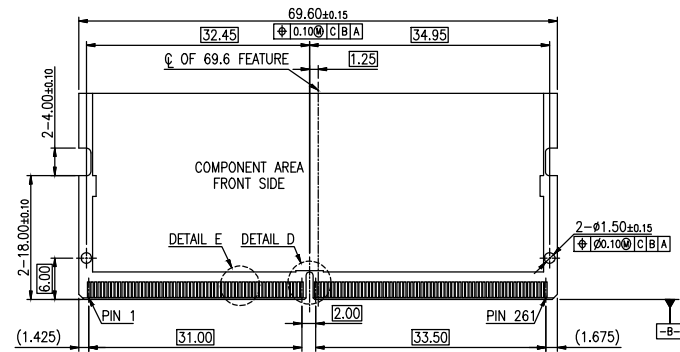

DETAIL E  
SCALE 2:1

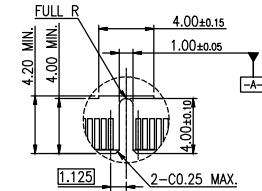

DETAIL D  
SCALE 2:1

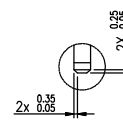
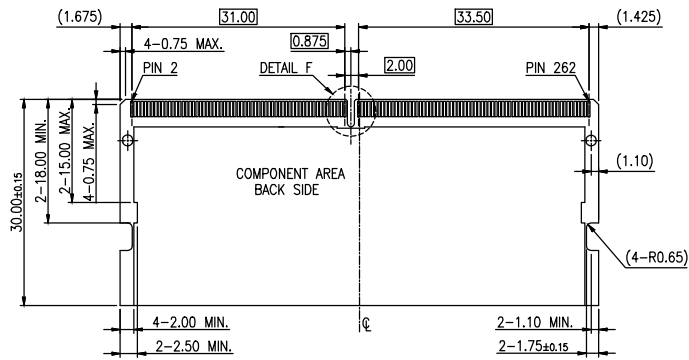

DETAIL G  
SCALE 2:1

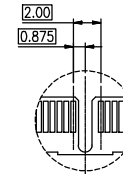

DETAIL F  
SCALE 2:1

RECOMMEND MODULE CONFIGURATION

UNLESS OTHERWISE SPECIFIED TOLERANCE			
UNIT:	DECIMAL	LINEAR	ANGLES
mm	X.	±0.50	±5°
	X.X	±0.25	±3°
	X.XX	±0.12	±1°



www.attend.com.tw

DRAWN	Fros	2021/03/23	DRAWN NAME:	262 PIN DDR5 SODIMM, 0.5MM PITCH PACKAGE	
CHECKED	Tim	2021/03/23	PRODUCT NO.		
APPROVED	Ken	2021/03/23	FILE NAME	126A-CARD_B_1	
SCALE	1.25	SHEET	1/1	SIZE	A4

REV.	DESCRIPTION	DRAWN	DATE
1	INITIAL RELEASE	FROS	2021/03/23

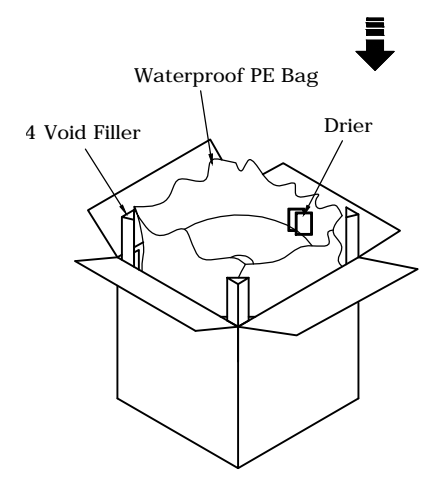
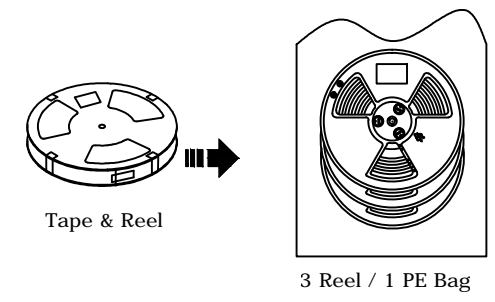
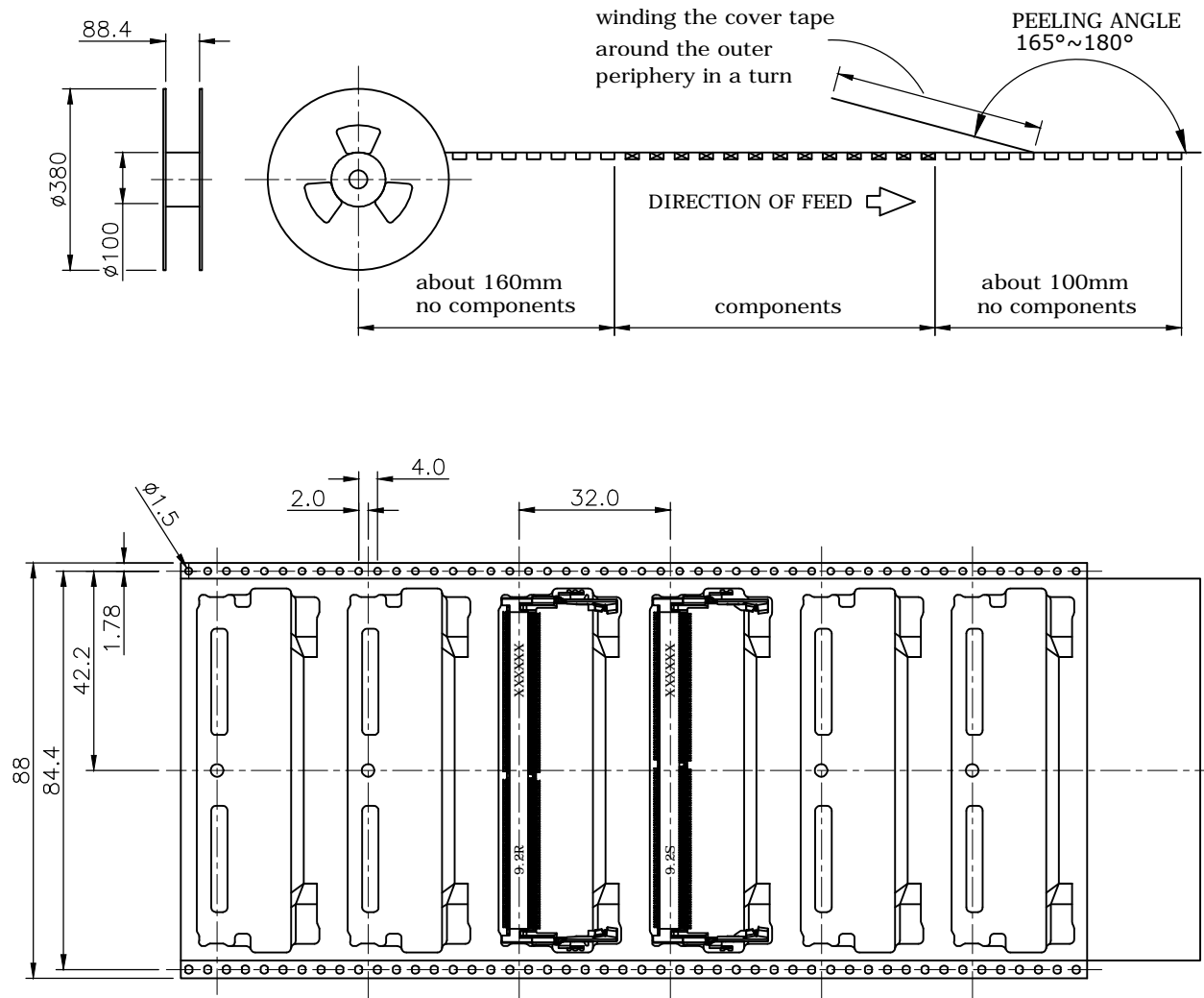

PART NO.	PCS/REEL	REEL/CARTON	PCS/CARTON
126A-92A00	270	3	810
126A-92A10	270	3	810

UNLESS OTHERWISE SPECIFIED TOLERANCE

UNIT:	DECIMAL	LINEAR	ANGLES
mm	X.	±0.50	±5°
	X.X	±0.25	±3°
	X.XX	±0.12	±1°



www.attend.com.tw

DRAWN	Fros	2021/03/23	DRAWN NAME: Packaging for DDR5 SODIMM Socket, Horizontal, 9.2H, Reel 88.0mm
CHECKED	Tim	2021/03/23	
APPROVED	Ken	2021/03/23	
			PRODUCT NO. SEE TABLE
SCALE	N/A	SHEET 1/1	SIZE A4
FILE NAME		126A-92AX0_D_1	