



flowPIM 0

650 V / 30 A

Topology features

- Converter+Brake+Inverter
- Open Emitter configuration
- Temperature sensor

Component features

- Easy paralleling
- Low collector emitter saturation voltage
- Low turn-off losses
- Positive temperature coefficient

Housing features

- Base isolation: Al₂O₃
- Convex shaped substrate for superior thermal contact
- Thermo-mechanical push-and-pull force relief
- Solder pin

Target applications

- Embedded Drives
- Industrial Drives

Types

- 10-FU07PMA030I7-P546B66

flow 0 12 mm housing

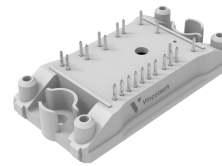

Schematic

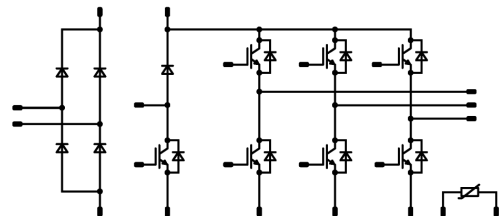



Vincotech

10-FU07PMA030I7-P546B66
datasheet

Maximum Ratings

$T_j = 25\text{ °C}$, unless otherwise specified

Parameter	Symbol	Conditions	Value	Unit
Inverter Switch				
Collector-emitter voltage	V_{CES}		650	V
Collector current (DC current)	I_C	$T_j = T_{jmax}$ $T_s = 80\text{ °C}$	40	A
Repetitive peak collector current	I_{CRM}	t_p limited by T_{jmax}	90	A
Total power dissipation	P_{tot}	$T_j = T_{jmax}$ $T_s = 80\text{ °C}$	64	W
Gate-emitter voltage	V_{GES}		± 20	V
Short circuit ratings	t_{SC}	$V_{GE} = 15\text{ V}$, $V_{CC} = 400\text{ V}$ $T_j = 150\text{ °C}$	3	μs
Maximum junction temperature	T_{jmax}		175	$^{\circ}\text{C}$

Inverter Diode

Peak repetitive reverse voltage	V_{RRM}		650	V
Forward current (DC current)	I_F	$T_j = T_{jmax}$ $T_s = 80\text{ °C}$	34	A
Repetitive peak forward current	I_{FRM}	t_p limited by T_{jmax}	90	A
Total power dissipation	P_{tot}	$T_j = T_{jmax}$ $T_s = 80\text{ °C}$	54	W
Maximum junction temperature	T_{jmax}		175	$^{\circ}\text{C}$

Brake Switch

Collector-emitter voltage	V_{CES}		650	V
Collector current (DC current)	I_C	$T_j = T_{jmax}$ $T_s = 80\text{ °C}$	40	A
Repetitive peak collector current	I_{CRM}	t_p limited by T_{jmax}	90	A
Total power dissipation	P_{tot}	$T_j = T_{jmax}$ $T_s = 80\text{ °C}$	64	W
Gate-emitter voltage	V_{GES}		± 20	V
Short circuit ratings	t_{SC}	$V_{GE} = 15\text{ V}$, $V_{CC} = 400\text{ V}$ $T_j = 150\text{ °C}$	3	μs
Maximum junction temperature	T_{jmax}		175	$^{\circ}\text{C}$

**Maximum Ratings** $T_j = 25\text{ °C}$, unless otherwise specified

Parameter	Symbol	Conditions	Value	Unit
Brake Diode				
Peak repetitive reverse voltage	V_{RRM}		650	V
Forward current (DC current)	I_F	$T_j = T_{jmax}$ $T_s = 80\text{ °C}$	27	A
Repetitive peak forward current	I_{FRM}	t_p limited by T_{jmax}	60	A
Total power dissipation	P_{tot}	$T_j = T_{jmax}$ $T_s = 80\text{ °C}$	46	W
Maximum junction temperature	T_{jmax}		175	°C

Brake Sw. Protection Diode

Peak repetitive reverse voltage	V_{RRM}		650	V
Forward current (DC current)	I_F	$T_j = T_{jmax}$ $T_s = 80\text{ °C}$	27	A
Repetitive peak forward current	I_{FRM}	t_p limited by T_{jmax}	60	A
Total power dissipation	P_{tot}	$T_j = T_{jmax}$ $T_s = 80\text{ °C}$	46	W
Maximum junction temperature	T_{jmax}		175	°C

Rectifier Diode

Peak repetitive reverse voltage	V_{RRM}		1600	V
Forward current (DC current)	I_F	$T_j = T_{jmax}$ $T_s = 80\text{ °C}$	53	A
Surge (non-repetitive) forward current	I_{FSM}	Single Half Sine Wave, $t_p = 10\text{ ms}$ $T_j = 150\text{ °C}$	400	A
Surge current capability	I^2t		800	A ² s
Total power dissipation	P_{tot}	$T_j = T_{jmax}$ $T_s = 80\text{ °C}$	60	W
Maximum junction temperature	T_{jmax}		150	°C



Vincotech

10-FU07PMA030I7-P546B66
datasheet

Maximum Ratings

$T_j = 25\text{ °C}$, unless otherwise specified

Parameter	Symbol	Conditions	Value	Unit
-----------	--------	------------	-------	------

Module Properties

Thermal Properties

Storage temperature	T_{stg}		-40...+125	°C
Operation temperature under switching condition	T_{jop}		-40...+($T_{jmax} - 25$)	°C

Isolation Properties

Isolation voltage	V_{isol}	DC Test Voltage* $t_p = 2\text{ s}$	6000	V
Isolation voltage	V_{isol}	AC Voltage $t_p = 1\text{ min}$	2500	V
Creepage distance			>12,7	mm
Clearance			9,67	mm
Comparative Tracking Index	CTI		≥ 200	

*100 % tested in production



Characteristic Values

Parameter	Symbol	Conditions					Values			Unit
		V_{GS} [V]	V_{GE} [V]	V_{DS} [V]	I_D [A]	T_j [°C]	Min	Typ	Max	

Inverter Switch

Static

Gate-emitter threshold voltage	$V_{GE(th)}$	$V_{CE} = V_{GE}$			0,0003	25	4,35	5	5,65	V
Collector-emitter saturation voltage	$V_{CE(sat)}$		15		30	25 125 150		1,3 1,37 1,39	1,65 ⁽¹⁾	V
Collector-emitter cut-off current	I_{CES}		0	650		25			20	μA
Gate-emitter leakage current	I_{GES}		0	650		25			100	nA
Internal gate resistance	r_g							None		Ω
Input capacitance	C_{ies}							1900		pF
Output capacitance	C_{oes}	$f = 1$ Mhz	0	25		25		62		pF
Reverse transfer capacitance	C_{res}							20		pF
Gate charge	Q_g	$V_{CC} = 520$ V	15		30	25		180		nC

Thermal

Thermal resistance junction to sink ⁽²⁾	$R_{th(j-s)}$	$\lambda_{paste} = 3,4$ W/mK (PSX)						1,48		K/W
--	---------------	------------------------------------	--	--	--	--	--	------	--	-----

Dynamic

Turn-on delay time	$t_{d(on)}$					25 125 150		125,26 128,94 129,69		ns
Rise time	t_r					25 125 150		37,51 38 37,95		ns
Turn-off delay time	$t_{d(off)}$					25 125 150		135,64 162,13 168,04		ns
Fall time	t_f					25 125 150		31,14 49,86 57,19		ns
Turn-on energy (per pulse)	E_{on}	$Q_{tFWD} = 0,707$ μC $Q_{tFWD} = 1,57$ μC $Q_{tFWD} = 1,83$ μC				25 125 150		1 1,3 1,37		mWs
Turn-off energy (per pulse)	E_{off}					25 125 150		0,622 0,917 0,994		mWs



Vincotech

10-FU07PMA030I7-P546B66
datasheet

Characteristic Values

Parameter	Symbol	Conditions					Values			Unit
		V_{GE} [V] V_{GS} [V]	V_{CE} [V] V_{DS} [V] V_F [V]	I_C [A] I_D [A] I_F [A]	T_j [°C]	Min	Typ	Max		
Inverter Diode										
Static										
Forward voltage	V_F				30	25 125 150		1,63 1,53 1,5	2 ⁽¹⁾	V
Reverse leakage current	I_R	$V_r = 650$ V				25			20	μA
Thermal										
Thermal resistance junction to sink ⁽²⁾	$R_{th(j-s)}$	$\lambda_{paste} = 3,4$ W/mK (PSX)						1,77		K/W
Dynamic										
Peak recovery current	I_{RM}					25 125 150		10,96 17,4 18,91		A
Reverse recovery time	t_{rr}					25 125 150		105,71 147,61 161,11		ns
Recovered charge	Q_r	$di/dt=722$ A/μs $di/dt=842$ A/μs $di/dt=814$ A/μs	±15	350	40	25 125 150		0,707 1,57 1,83		μC
Reverse recovered energy	E_{rec}					25 125 150		0,136 0,321 0,384		mWs
Peak rate of fall of recovery current	$(di_r/dt)_{max}$					25 125 150		437,68 322,38 267,43		A/μs



Vincotech

10-FU07PMA030I7-P546B66
datasheet

Characteristic Values

Parameter	Symbol	Conditions					Values			Unit
		V_{GS} [V]	V_{GE} [V]	V_{DS} [V]	I_D [A]	T_j [°C]	Min	Typ	Max	

Brake Switch

Static

Gate-emitter threshold voltage	$V_{GE(th)}$	$V_{CE} = V_{GE}$			0,0003	25	4,35	5	5,65	V
Collector-emitter saturation voltage	$V_{CE(sat)}$		15		30	25 125 150		1,3 1,37 1,39	1,65 ⁽¹⁾	V
Collector-emitter cut-off current	I_{CES}		0	650		25			20	μA
Gate-emitter leakage current	I_{GES}		0	650		25			100	nA
Internal gate resistance	r_g							None		Ω
Input capacitance	C_{ies}							1900		pF
Output capacitance	C_{oes}	$f = 1$ Mhz	0	25		25		62		pF
Reverse transfer capacitance	C_{res}							20		pF
Gate charge	Q_g	$V_{CC} = 520$ V	15		30	25		180		nC

Thermal

Thermal resistance junction to sink ⁽²⁾	$R_{th(j-s)}$	$\lambda_{paste} = 3,4$ W/mK (PSX)						1,48		K/W
--	---------------	------------------------------------	--	--	--	--	--	------	--	-----

Dynamic

Turn-on delay time	$t_{d(on)}$					25 125 150		33,61 36,44 37,32		ns
Rise time	t_r					25 125 150		45,26 46,4 46,24		ns
Turn-off delay time	$t_{d(off)}$					25 125 150		294,96 327,11 335,09		ns
Fall time	t_f					25 125 150		38,77 29,31 30,78		ns
Turn-on energy (per pulse)	E_{on}	$Q_{tFWD} = 0,544$ μC $Q_{tFWD} = 1,23$ μC $Q_{tFWD} = 1,43$ μC				25 125 150		1,32 1,68 1,75		mWs
Turn-off energy (per pulse)	E_{off}					25 125 150		0,885 1,13 1,22		mWs



Vincotech

10-FU07PMA030I7-P546B66
datasheet

Characteristic Values

Parameter	Symbol	Conditions					Values			Unit
		V_{GE} [V] V_{GS} [V]	V_{CE} [V] V_{DS} [V] V_F [V]	I_C [A] I_D [A] I_F [A]	T_j [°C]	Min	Typ	Max		
Brake Diode										
Static										
Forward voltage	V_F				20	25 125 150		1,71 1,6 1,55	2 ⁽¹⁾	V
Reverse leakage current	I_R	$V_r = 650$ V				25			20	μA
Thermal										
Thermal resistance junction to sink ⁽²⁾	$R_{th(j-s)}$	$\lambda_{paste} = 3,4$ W/mK (PSX)						2,05		K/W
Dynamic										
Peak recovery current	I_{RM}					25 125 150		7,4 11,94 12,79		A
Reverse recovery time	t_{rr}					25 125 150		107,97 153,09 168,57		ns
Recovered charge	Q_r	$di/dt=547$ A/μs $di/dt=727$ A/μs $di/dt=652$ A/μs	0/15	400	40	25 125 150		0,544 1,23 1,43		μC
Reverse recovered energy	E_{rec}					25 125 150		0,117 0,282 0,338		mWs
Peak rate of fall of recovery current	$(di_r/dt)_{max}$					25 125 150		222,14 193,9 176,94		A/μs



Vincotech

Characteristic Values

Parameter	Symbol	Conditions					Values			Unit
		V_{GS} [V]	V_{GE} [V]	V_{DS} [V]	V_{CE} [V]	T_j [°C]	Min	Typ	Max	

Brake Sw. Protection Diode

Static

Forward voltage	V_F				20	25 125 150		1,71 1,6 1,55	2 ⁽¹⁾	V
Reverse leakage current	I_R	$V_r = 650$ V				25			20	μA

Thermal

Thermal resistance junction to sink ⁽²⁾	$R_{th(j-s)}$	$\lambda_{paste} = 3,4$ W/mK (PSX)						2,05		K/W
--	---------------	------------------------------------	--	--	--	--	--	------	--	-----

Rectifier Diode

Static

Forward voltage	V_F				5	25 125 150		0,874 0,753 0,723	1,1 ⁽¹⁾	V
Reverse leakage current	I_R	$V_r = 1600$ V				25 150			100 2000	μA

Thermal

Thermal resistance junction to sink ⁽²⁾	$R_{th(j-s)}$	$\lambda_{paste} = 3,4$ W/mK (PSX)						1,18		K/W
--	---------------	------------------------------------	--	--	--	--	--	------	--	-----



Vincotech

Characteristic Values

Parameter	Symbol	Conditions					Values			Unit
		V_{GS} [V]	V_{GE} [V]	V_{DS} [V]	V_{CE} [V]	T_j [°C]	Min	Typ	Max	

Thermistor

Static

Rated resistance	R					25		22		kΩ
Deviation of R100	$A_{R/R}$	$R_{100} = 1484 \Omega$				100	-5		5	%
Power dissipation	P					25		130		mW
Power dissipation constant	d					25		1,5		mW/K
B-value	$B_{(25/50)}$	Tol. $\pm 1 \%$						3962		K
B-value	$B_{(25/100)}$	Tol. $\pm 1 \%$						4000		K
Vincotech Thermistor Reference									I	

⁽¹⁾ Value at chip level

⁽²⁾ Only valid with pre-applied Vincotech thermal interface material.



Inverter Switch Characteristics

figure 1. IGBT

Typical output characteristics
 $I_C = f(V_{CE})$

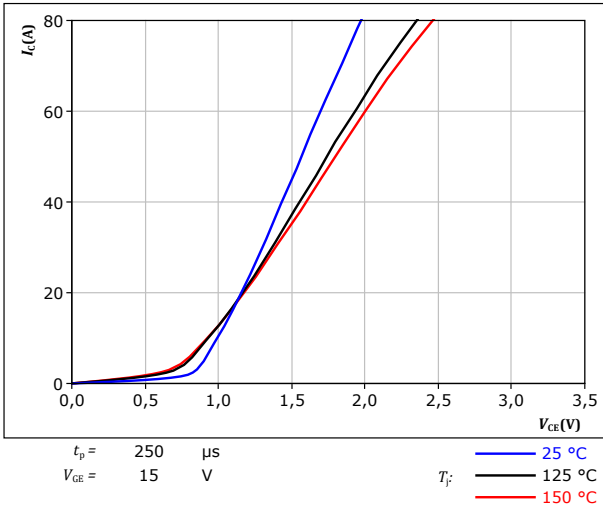

figure 2. IGBT

Typical output characteristics
 $I_C = f(V_{CE})$

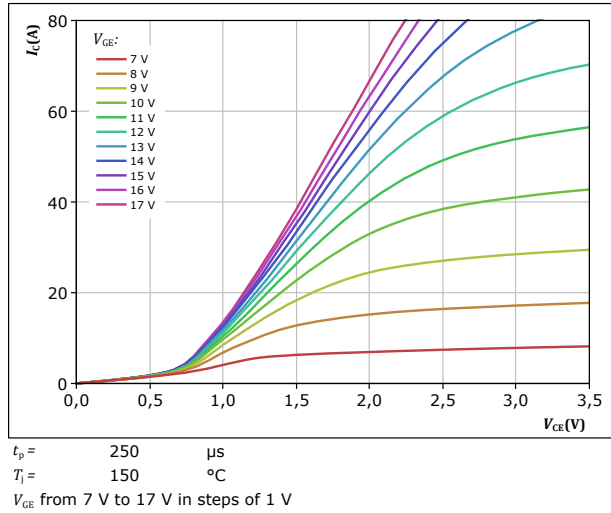

figure 3. IGBT

Typical transfer characteristics
 $I_C = f(V_{GE})$

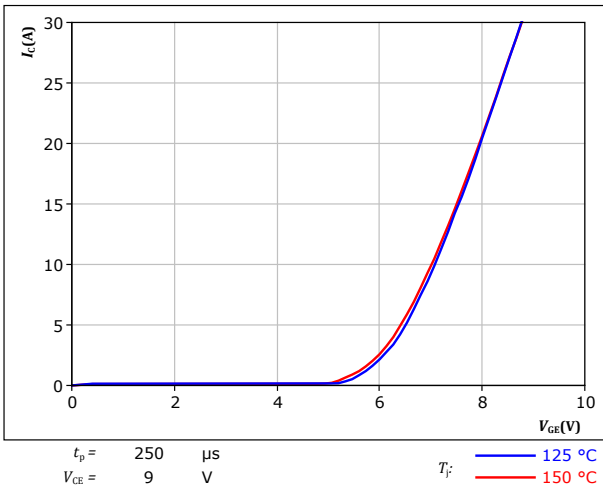
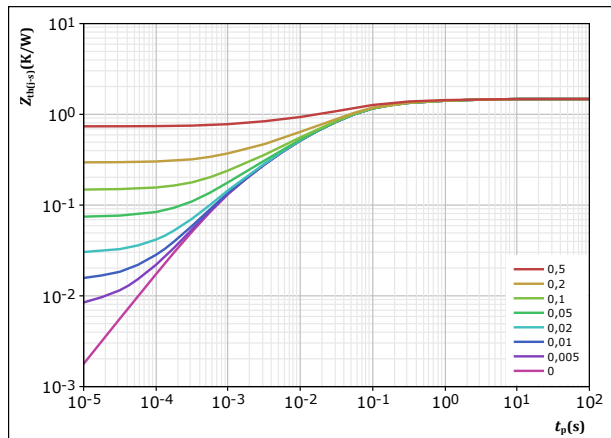

figure 4. IGBT

Transient thermal impedance as a function of pulse width
 $Z_{th(j-s)} = f(t_p)$



IGBT thermal model values

R (K/W)	τ (s)
9,19E-02	2,15E+00
2,02E-01	2,49E-01
7,11E-01	4,86E-02
3,53E-01	7,69E-03
1,16E-01	9,93E-04



Inverter Switch Characteristics

figure 5. IGBT

Safe operating area
 $I_C = f(V_{CE})$

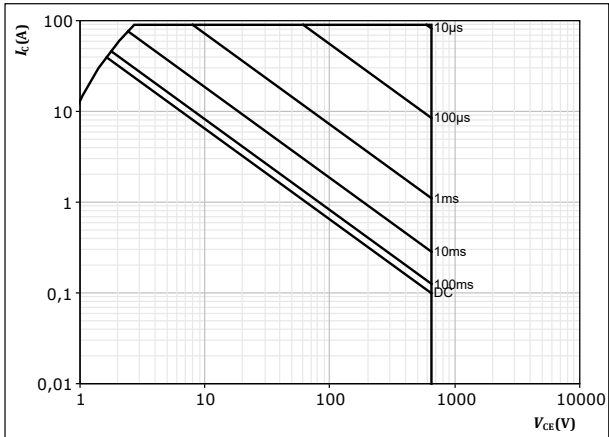

$D =$ single pulse
 $T_s = 80 \text{ } ^\circ\text{C}$
 $V_{GE} = 15 \text{ V}$
 $T_j = T_{jmax}$

figure 6. IGBT

Gate voltage vs gate charge
 $V_{GE} = f(Q_g)$

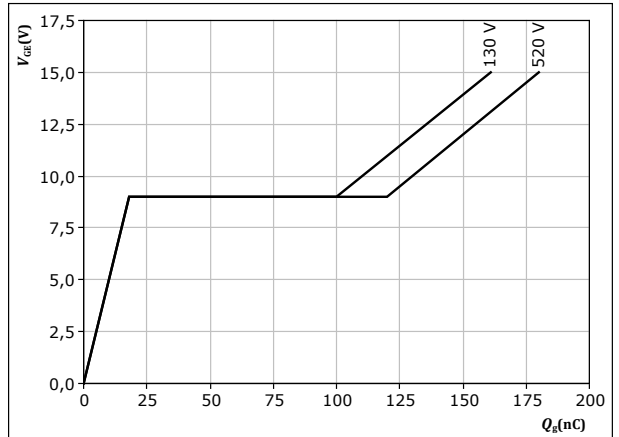

$I_C = 30 \text{ A}$
 $T_j = 25 \text{ } ^\circ\text{C}$



Inverter Diode Characteristics

figure 7. FWD

Typical forward characteristics

$$I_F = f(V_F)$$

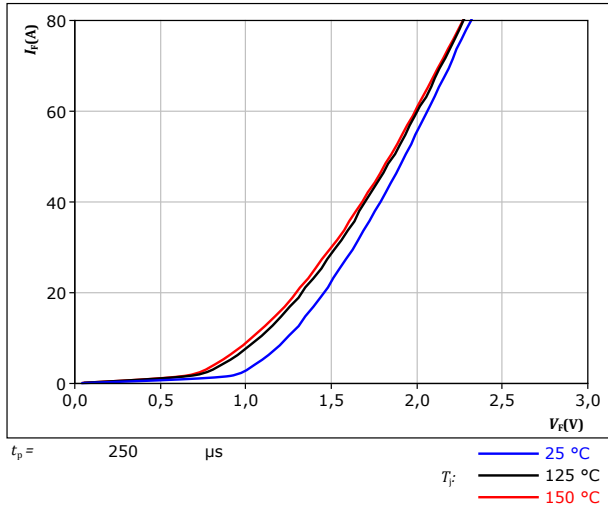
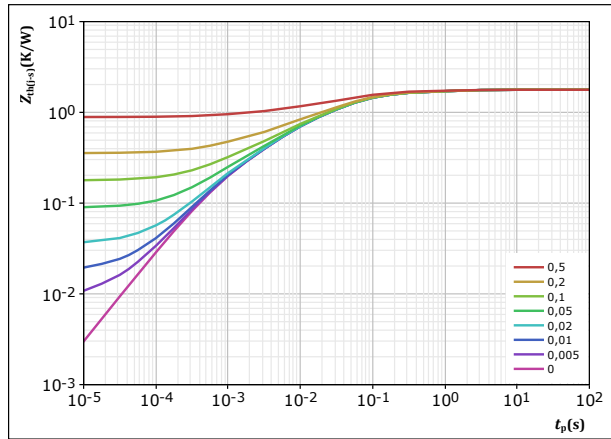

figure 8. FWD

Transient thermal impedance as a function of pulse width

$$Z_{th(j-s)} = f(t_p)$$



$D =$	t_p / T	
$R_{th(j-s)} =$	1,774	K/W
FWD thermal model values		
R (K/W)	τ (s)	
1,32E-01	1,37E+00	
4,18E-01	1,14E-01	
6,95E-01	3,10E-02	
3,92E-01	5,12E-03	
1,37E-01	6,90E-04	



Brake Switch Characteristics

figure 9. IGBT

Typical output characteristics
 $I_C = f(V_{CE})$

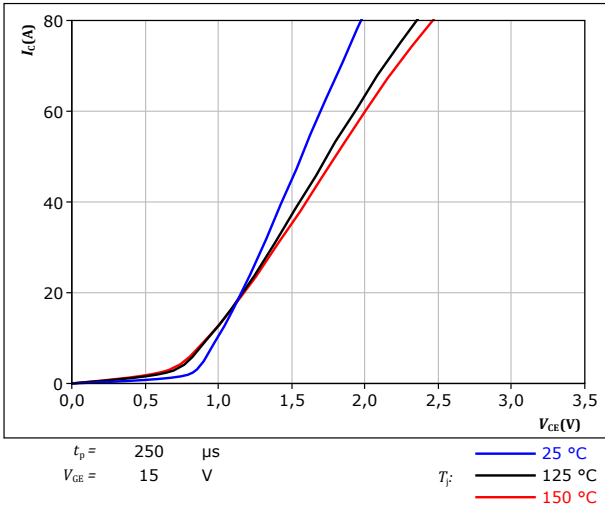

figure 10. IGBT

Typical output characteristics
 $I_C = f(V_{CE})$

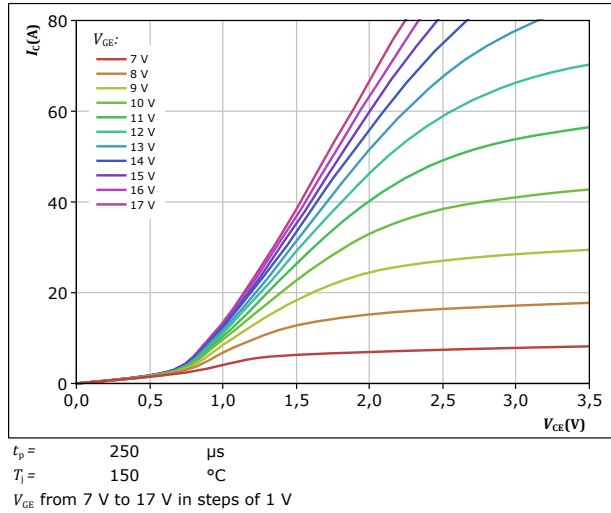

figure 11. IGBT

Typical transfer characteristics
 $I_C = f(V_{GE})$

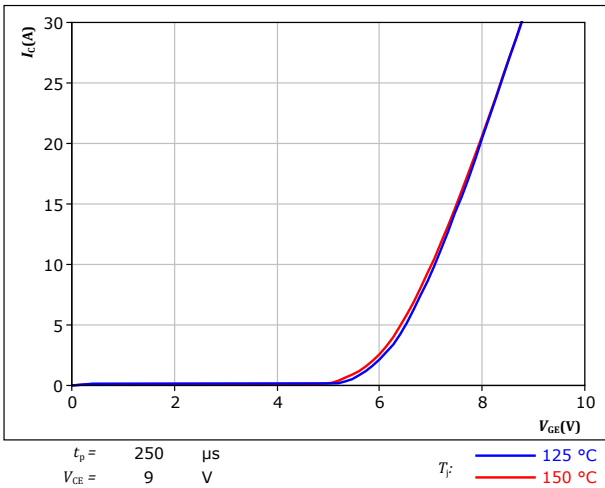
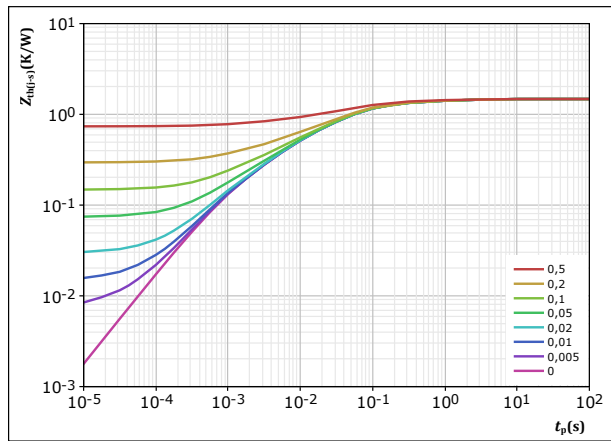

figure 12. IGBT

Transient thermal impedance as a function of pulse width
 $Z_{th(j-s)} = f(t_p)$



$D = t_p / T$
 $R_{th(j-s)} = 1,475 \text{ K/W}$

IGBT thermal model values

R (K/W)	τ (s)
9,19E-02	2,15E+00
2,02E-01	2,49E-01
7,11E-01	4,86E-02
3,53E-01	7,69E-03
1,16E-01	9,93E-04



Brake Switch Characteristics

figure 13. IGBT

Safe operating area
 $I_C = f(V_{CE})$

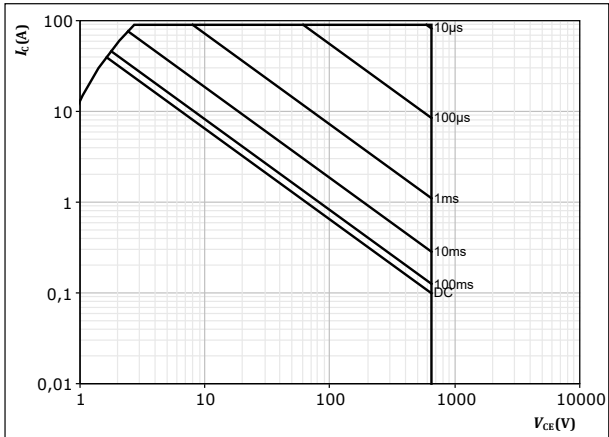

$D =$ single pulse
 $T_s = 80$ °C
 $V_{GE} = 15$ V
 $T_j = T_{jmax}$

figure 14. IGBT

Gate voltage vs gate charge
 $V_{GE} = f(Q_g)$

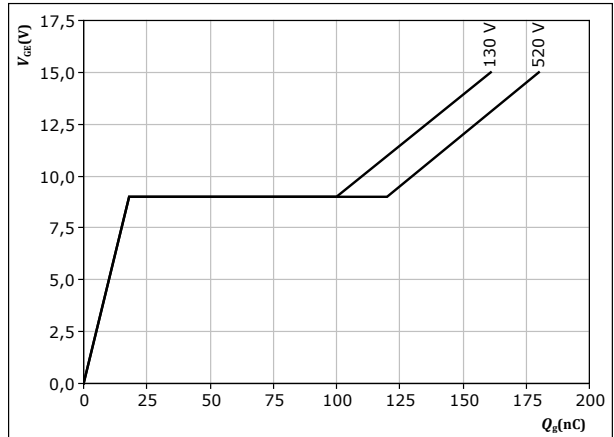

$I_C = 30$ A
 $T_j = 25$ °C



Brake Diode Characteristics

figure 15. FWD

Typical forward characteristics

$$I_F = f(V_F)$$

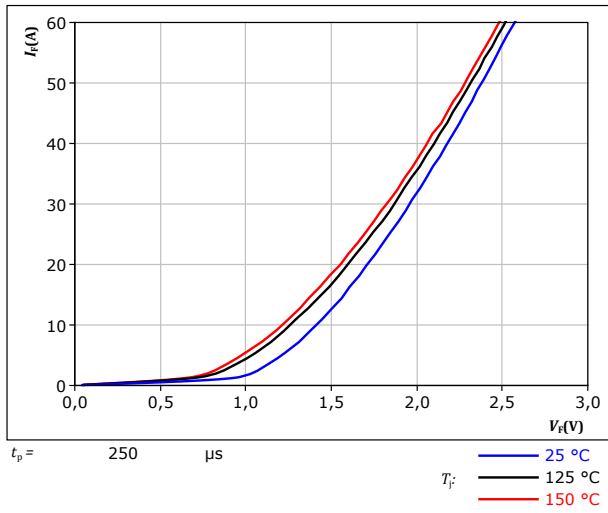
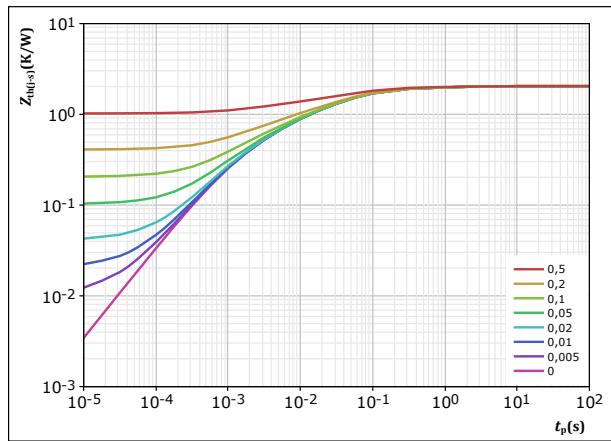

figure 16. FWD

Transient thermal impedance as a function of pulse width

$$Z_{th(j-s)} = f(t_p)$$



$D = \frac{t_p}{T}$
 $R_{th(j-s)} = 2,046 \text{ K/W}$
 FWD thermal model values

R (K/W)	τ (s)
1,18E-01	1,59E+00
4,10E-01	1,36E-01
7,87E-01	3,23E-02
4,93E-01	5,55E-03
2,39E-01	1,05E-03



Brake Sw. Protection Diode Characteristics

figure 17. FWD

Typical forward characteristics

$$I_F = f(V_F)$$

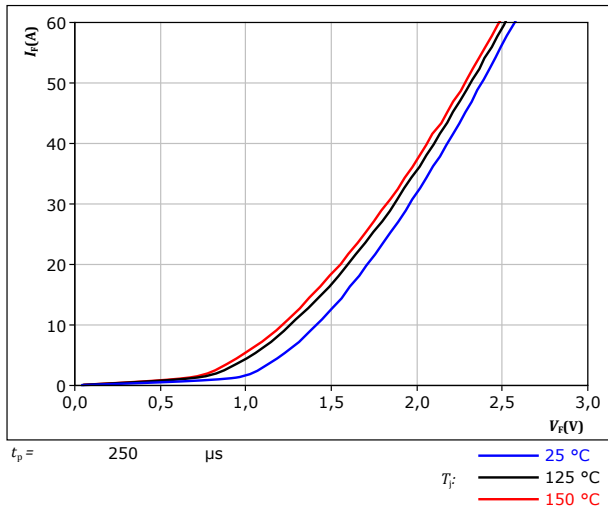
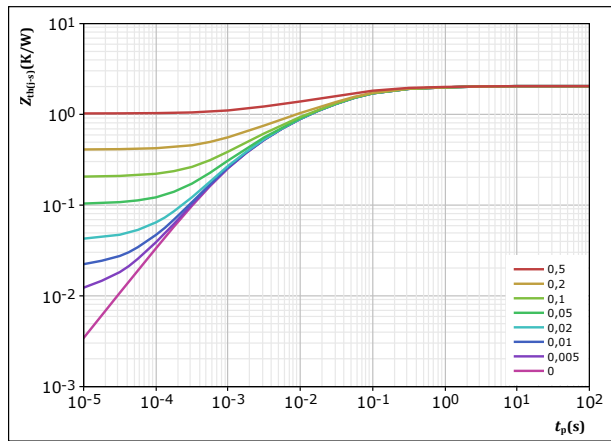

figure 18. FWD

Transient thermal impedance as a function of pulse width

$$Z_{th(j-s)} = f(t_p)$$



$D = \frac{t_p}{T}$
 $R_{th(j-s)} = 2,046 \text{ K/W}$
 FWD thermal model values

R (K/W)	τ (s)
1,18E-01	1,59E+00
4,10E-01	1,36E-01
7,87E-01	3,23E-02
4,93E-01	5,55E-03
2,39E-01	1,05E-03



Rectifier Diode Characteristics

figure 19. Rectifier

Typical forward characteristics

$$I_F = f(V_F)$$

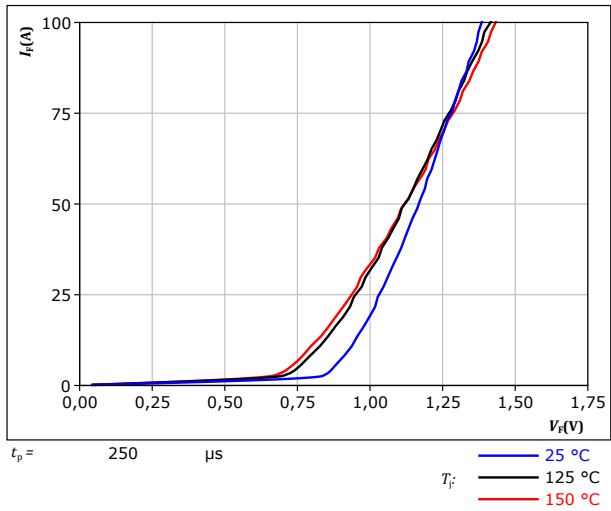
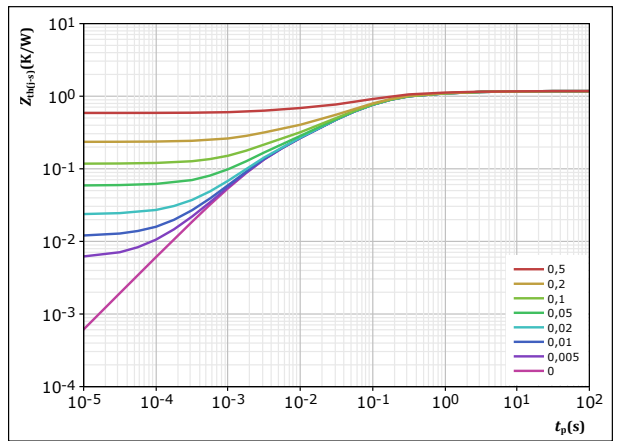

figure 20. Rectifier

Transient thermal impedance as a function of pulse width

$$Z_{th(j-s)} = f(t_p)$$



Rectifier thermal model values

R (K/W)	τ (s)
4,14E-02	6,95E+00
1,33E-01	9,25E-01
5,37E-01	1,26E-01
3,38E-01	2,82E-02
1,26E-01	2,80E-03



Thermistor Characteristics

figure 21. Thermistor

Typical NTC characteristic as function of temperature

$$R_T = f(T)$$

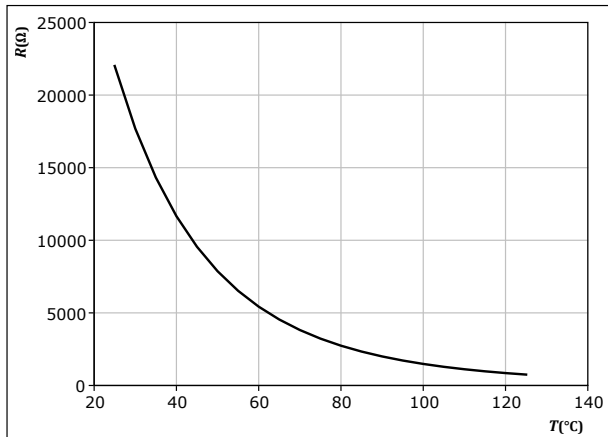



Inverter Switching Characteristics

figure 22. IGBT

Typical switching energy losses as a function of collector current
 $E = f(I_c)$

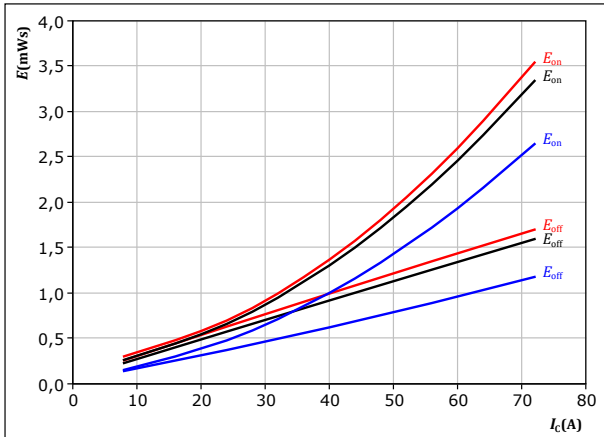

With an inductive load at

$V_{CE} =$	350	V	$T_j:$	—	25 °C
$V_{GE} =$	±15	V		—	125 °C
$R_{g(on)} =$	16	Ω		—	150 °C
$R_{g(off)} =$	16	Ω			

figure 23. IGBT

Typical switching energy losses as a function of IGBT turn on gate resistor
 $E = f(R_g)$

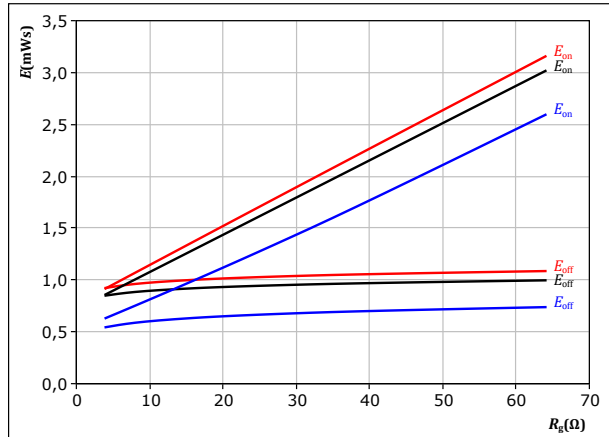

With an inductive load at

$V_{CE} =$	350	V	$T_j:$	—	25 °C
$V_{GE} =$	±15	V		—	125 °C
$I_c =$	40	A		—	150 °C

figure 24. FWD

Typical reverse recovered energy loss as a function of collector current
 $E_{rec} = f(I_c)$

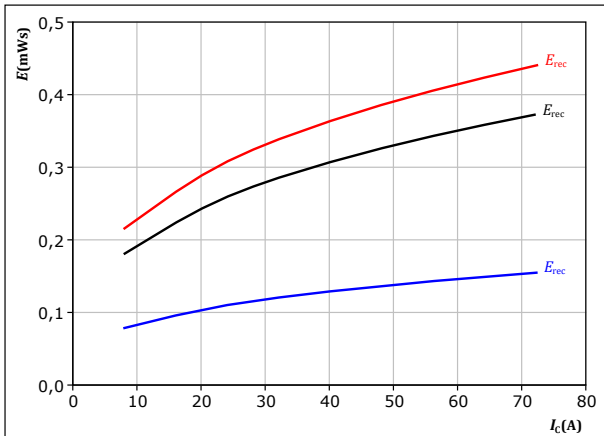

With an inductive load at

$V_{CE} =$	350	V	$T_j:$	—	25 °C
$V_{GE} =$	±15	V		—	125 °C
$R_{g(on)} =$	16	Ω		—	150 °C

figure 25. FWD

Typical reverse recovered energy loss as a function of IGBT turn on gate resistor
 $E_{rec} = f(R_g)$

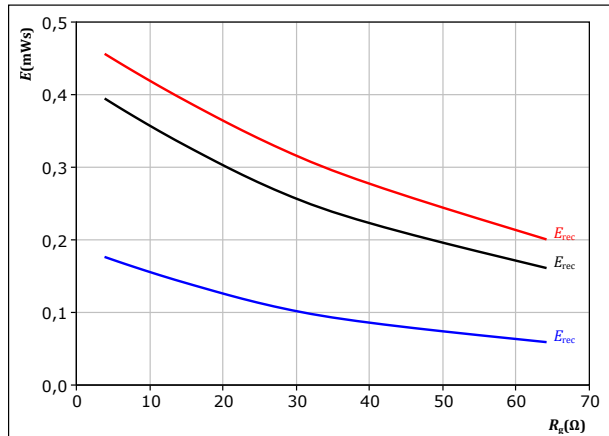

With an inductive load at

$V_{CE} =$	350	V	$T_j:$	—	25 °C
$V_{GE} =$	±15	V		—	125 °C
$I_c =$	40	A		—	150 °C



Inverter Switching Characteristics

figure 26. IGBT

Typical switching times as a function of collector current
 $t = f(I_c)$

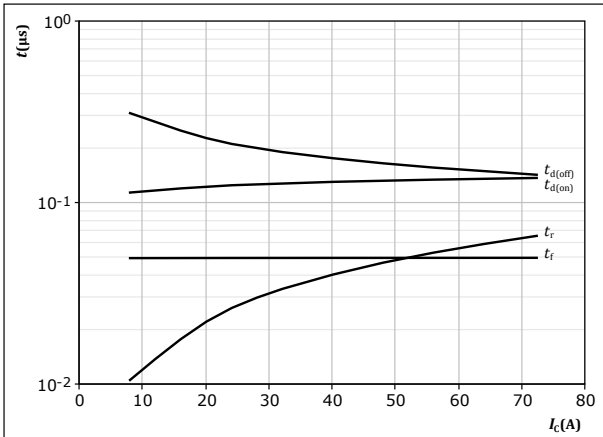

With an inductive load at
 $T_j = 150 \text{ }^\circ\text{C}$
 $V_{CE} = 350 \text{ V}$
 $V_{GE} = \pm 15 \text{ V}$
 $R_{g(on)} = 16 \text{ } \Omega$
 $R_{g(off)} = 16 \text{ } \Omega$

figure 27. IGBT

Typical switching times as a function of IGBT turn on gate resistor
 $t = f(R_g)$

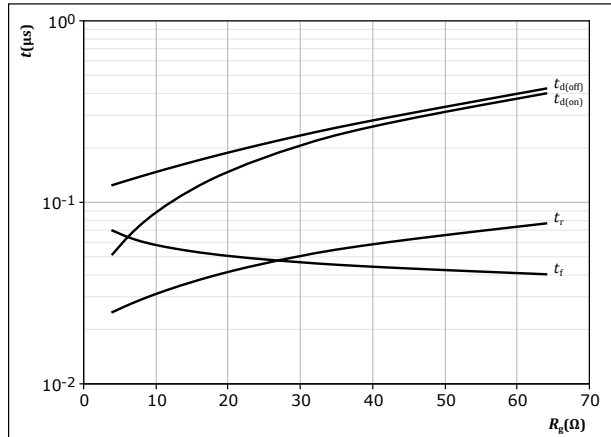

With an inductive load at
 $T_j = 150 \text{ }^\circ\text{C}$
 $V_{CE} = 350 \text{ V}$
 $V_{GE} = \pm 15 \text{ V}$
 $I_c = 40 \text{ A}$

figure 28. FWD

Typical reverse recovery time as a function of collector current
 $t_{rr} = f(I_c)$

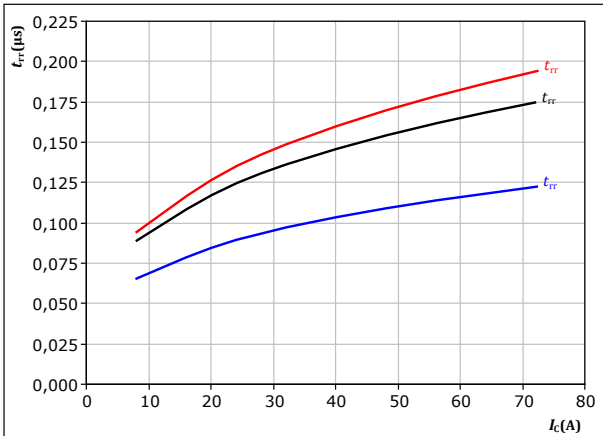

With an inductive load at
 $V_{CE} = 350 \text{ V}$
 $V_{GE} = \pm 15 \text{ V}$
 $R_{g(on)} = 16 \text{ } \Omega$
 $T_j: \text{ } \text{---} 25 \text{ }^\circ\text{C}$
 $\text{---} 125 \text{ }^\circ\text{C}$
 $\text{---} 150 \text{ }^\circ\text{C}$

figure 29. FWD

Typical reverse recovery time as a function of IGBT turn on gate resistor
 $t_{rr} = f(R_{g(on)})$

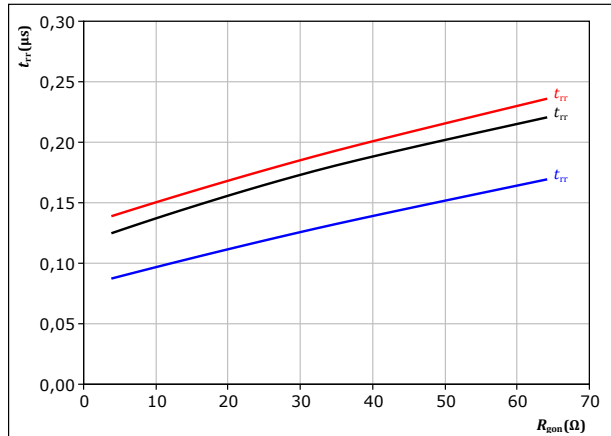

With an inductive load at
 $V_{CE} = 350 \text{ V}$
 $V_{GE} = \pm 15 \text{ V}$
 $I_c = 40 \text{ A}$
 $T_j: \text{ } \text{---} 25 \text{ }^\circ\text{C}$
 $\text{---} 125 \text{ }^\circ\text{C}$
 $\text{---} 150 \text{ }^\circ\text{C}$



Inverter Switching Characteristics

figure 30. FWD

Typical recovered charge as a function of collector current

$$Q_r = f(I_c)$$

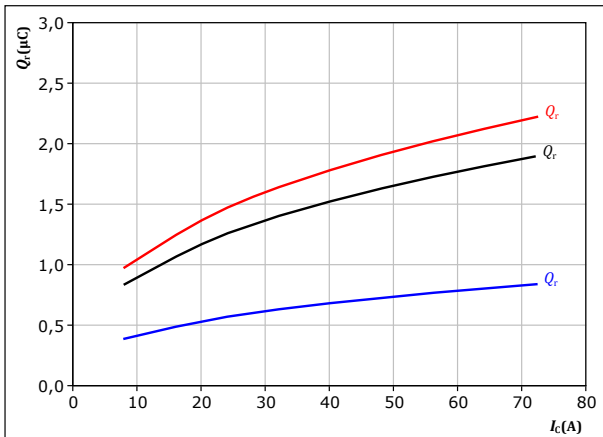

With an inductive load at

$V_{CE} = 350 \text{ V}$
 $V_{GE} = \pm 15 \text{ V}$
 $R_{gon} = 16 \ \Omega$

T_j : — 25 °C
— 125 °C
— 150 °C

figure 31. FWD

Typical recovered charge as a function of IGBT turn on gate resistor

$$Q_r = f(R_{gon})$$

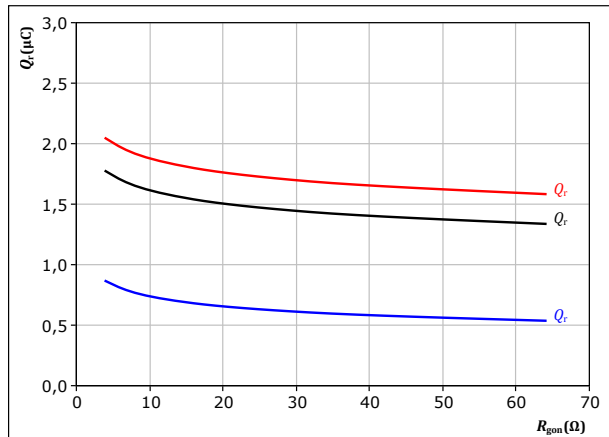

With an inductive load at

$V_{CE} = 350 \text{ V}$
 $V_{GE} = \pm 15 \text{ V}$
 $I_c = 40 \text{ A}$

T_j : — 25 °C
— 125 °C
— 150 °C

figure 32. FWD

Typical peak reverse recovery current as a function of collector current

$$I_{RM} = f(I_c)$$

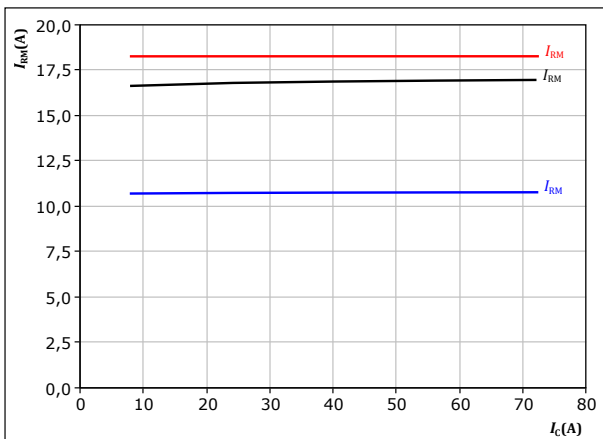

With an inductive load at

$V_{CE} = 350 \text{ V}$
 $V_{GE} = \pm 15 \text{ V}$
 $R_{gon} = 16 \ \Omega$

T_j : — 25 °C
— 125 °C
— 150 °C

figure 33. FWD

Typical peak reverse recovery current as a function of IGBT turn on gate resistor

$$I_{RM} = f(R_{gon})$$

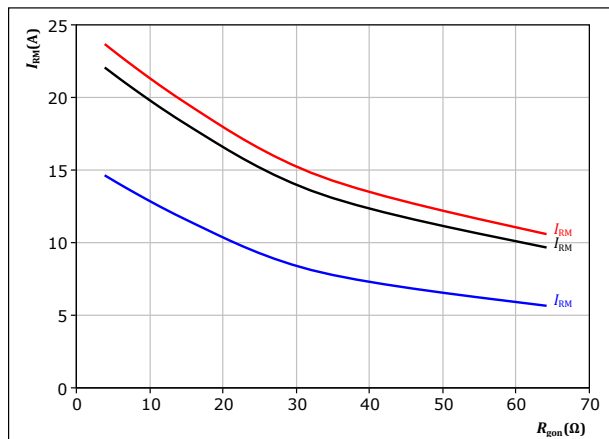

With an inductive load at

$V_{CE} = 350 \text{ V}$
 $V_{GE} = \pm 15 \text{ V}$
 $I_c = 40 \text{ A}$

T_j : — 25 °C
— 125 °C
— 150 °C



Inverter Switching Characteristics

figure 34. FWD

Typical rate of fall of forward and reverse recovery current as a function of collector current
 $di_f/dt, di_{rr}/dt = f(I_c)$

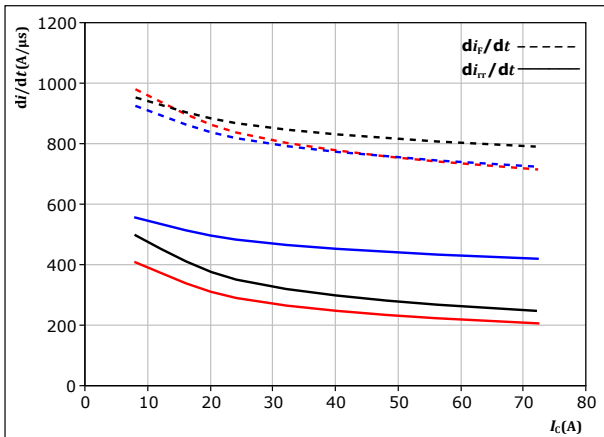

With an inductive load at

$V_{CE} = 350 \text{ V}$	$T_j = 25 \text{ }^\circ\text{C}$
$V_{GE} = \pm 15 \text{ V}$	$T_j = 125 \text{ }^\circ\text{C}$
$R_{gon} = 16 \text{ } \Omega$	$T_j = 150 \text{ }^\circ\text{C}$

figure 35. FWD

Typical rate of fall of forward and reverse recovery current as a function of turn on gate resistor
 $di_f/dt, di_{rr}/dt = f(R_{gon})$

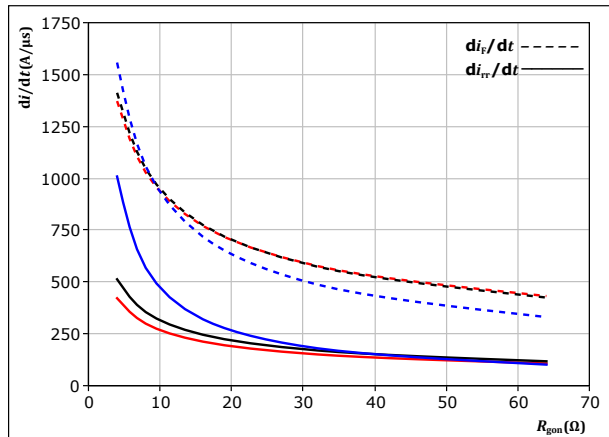

With an inductive load at

$V_{CE} = 350 \text{ V}$	$T_j = 25 \text{ }^\circ\text{C}$
$V_{GE} = \pm 15 \text{ V}$	$T_j = 125 \text{ }^\circ\text{C}$
$I_c = 40 \text{ A}$	$T_j = 150 \text{ }^\circ\text{C}$

figure 36. IGBT

Reverse bias safe operating area

$I_c = f(V_{CE})$

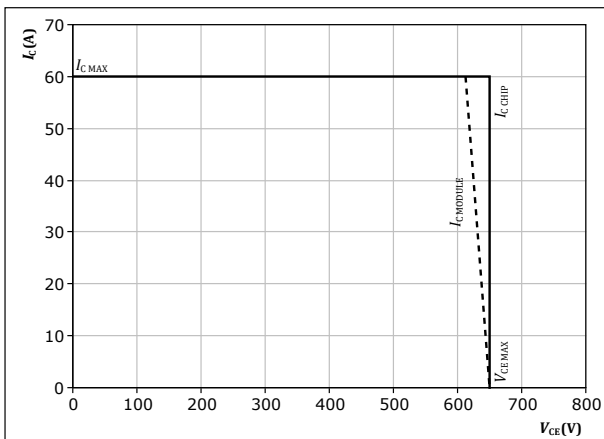

At $T_j = 150 \text{ }^\circ\text{C}$
 $R_{gon} = 16 \text{ } \Omega$
 $R_{goff} = 16 \text{ } \Omega$



Brake Switching Characteristics

figure 37. IGBT

Typical switching energy losses as a function of collector current
 $E = f(I_c)$

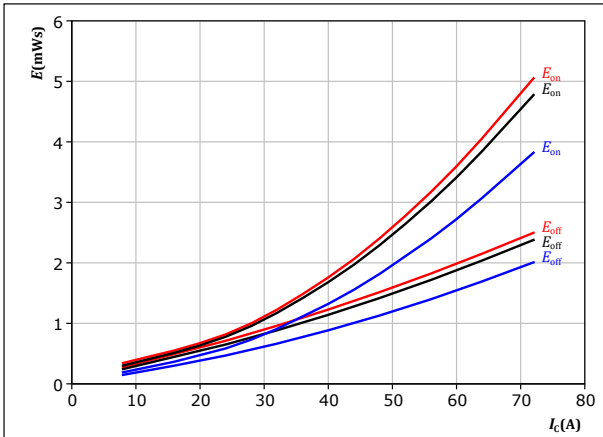

With an inductive load at

$V_{CE} = 400$ V	$T_j:$ — 25 °C
$V_{GE} = 0/15$ V	— 125 °C
$R_{g(on)} = 16$ Ω	— 150 °C
$R_{g(off)} = 16$ Ω	

figure 38. IGBT

Typical switching energy losses as a function of IGBT turn on gate resistor
 $E = f(R_g)$

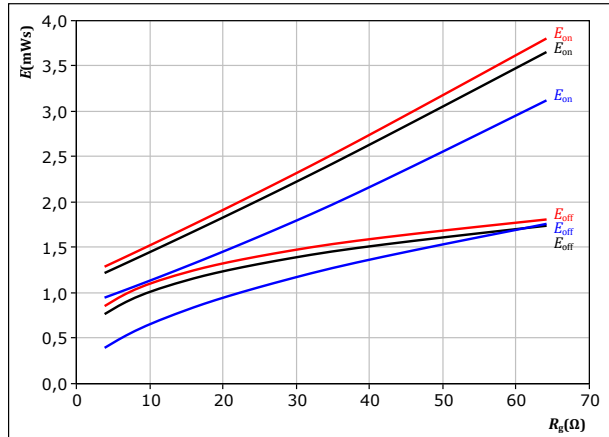

With an inductive load at

$V_{CE} = 400$ V	$T_j:$ — 25 °C
$V_{GE} = 0/15$ V	— 125 °C
$I_c = 40$ A	— 150 °C

figure 39. FWD

Typical reverse recovered energy loss as a function of collector current
 $E_{rec} = f(I_c)$

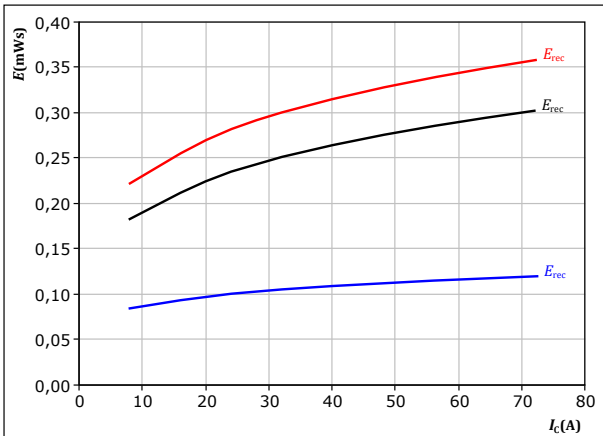

With an inductive load at

$V_{CE} = 400$ V	$T_j:$ — 25 °C
$V_{GE} = 0/15$ V	— 125 °C
$R_{g(on)} = 16$ Ω	— 150 °C

figure 40. FWD

Typical reverse recovered energy loss as a function of IGBT turn on gate resistor
 $E_{rec} = f(R_g)$

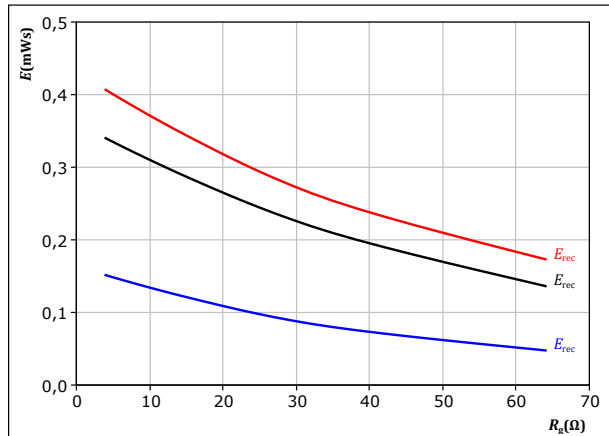

With an inductive load at

$V_{CE} = 400$ V	$T_j:$ — 25 °C
$V_{GE} = 0/15$ V	— 125 °C
$I_c = 40$ A	— 150 °C



Brake Switching Characteristics

figure 41. IGBT

Typical switching times as a function of collector current
 $t = f(I_c)$

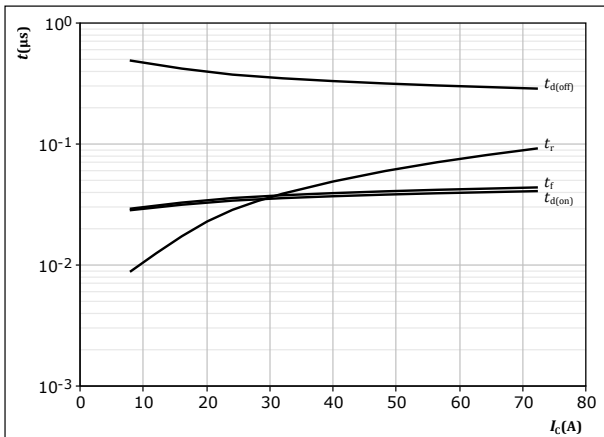

With an inductive load at
 $T_j = 150 \text{ }^\circ\text{C}$
 $V_{CE} = 400 \text{ V}$
 $V_{GE} = 0/15 \text{ V}$
 $R_{gon} = 16 \text{ } \Omega$
 $R_{goff} = 16 \text{ } \Omega$

figure 42. IGBT

Typical switching times as a function of IGBT turn on gate resistor
 $t = f(R_g)$

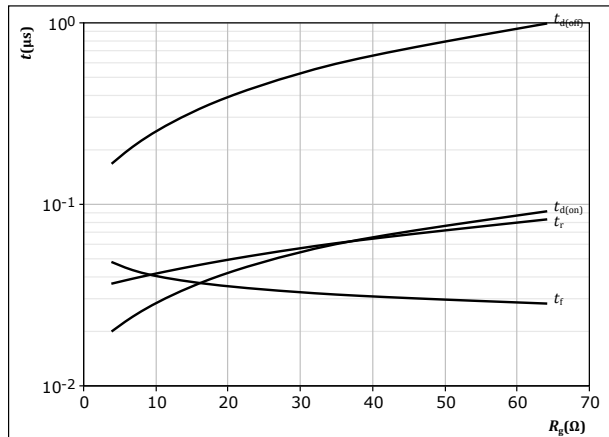

With an inductive load at
 $T_j = 150 \text{ }^\circ\text{C}$
 $V_{CE} = 400 \text{ V}$
 $V_{GE} = 0/15 \text{ V}$
 $I_c = 40 \text{ A}$

figure 43. FWD

Typical reverse recovery time as a function of collector current
 $t_{rr} = f(I_c)$

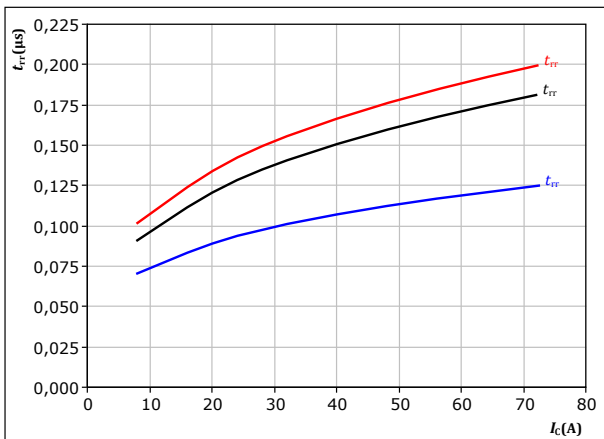

With an inductive load at
 $V_{CE} = 400 \text{ V}$
 $V_{GE} = 0/15 \text{ V}$
 $R_{gon} = 16 \text{ } \Omega$
 $T_j:$ — 25 °C
 — 125 °C
 — 150 °C

figure 44. FWD

Typical reverse recovery time as a function of IGBT turn on gate resistor
 $t_{rr} = f(R_{gon})$

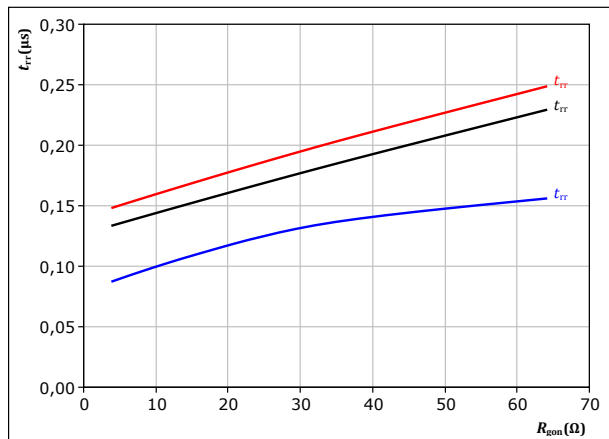

With an inductive load at
 $V_{CE} = 400 \text{ V}$
 $V_{GE} = 0/15 \text{ V}$
 $I_c = 40 \text{ A}$
 $T_j:$ — 25 °C
 — 125 °C
 — 150 °C



Brake Switching Characteristics

figure 45. FWD

Typical recovered charge as a function of collector current

$$Q_r = f(I_c)$$

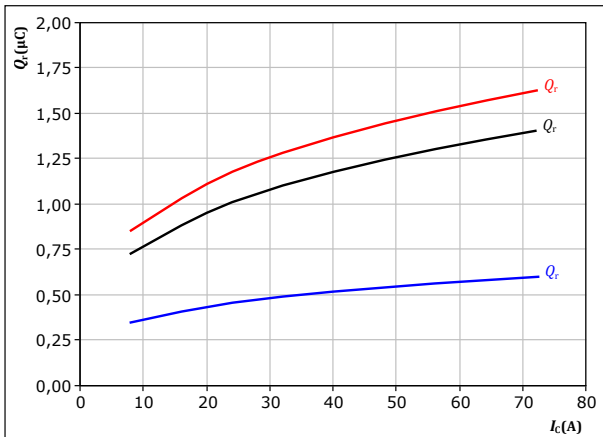

With an inductive load at

$V_{CE} = 400$ V
 $V_{GE} = 0/15$ V
 $R_{gon} = 16$ Ω

T_j : — 25 °C
— 125 °C
— 150 °C

figure 46. FWD

Typical recovered charge as a function of IGBT turn on gate resistor

$$Q_r = f(R_{gon})$$

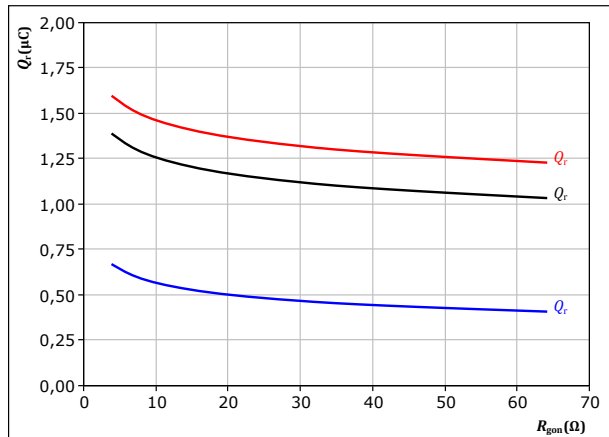

With an inductive load at

$V_{CE} = 400$ V
 $V_{GE} = 0/15$ V
 $I_c = 40$ A

T_j : — 25 °C
— 125 °C
— 150 °C

figure 47. FWD

Typical peak reverse recovery current as a function of collector current

$$I_{RM} = f(I_c)$$

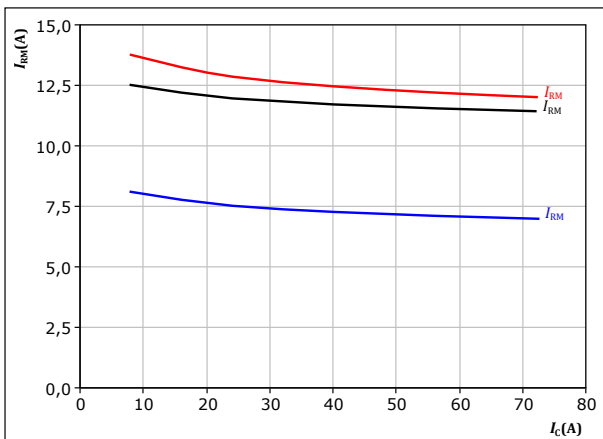

With an inductive load at

$V_{CE} = 400$ V
 $V_{GE} = 0/15$ V
 $R_{gon} = 16$ Ω

T_j : — 25 °C
— 125 °C
— 150 °C

figure 48. FWD

Typical peak reverse recovery current as a function of IGBT turn on gate resistor

$$I_{RM} = f(R_{gon})$$

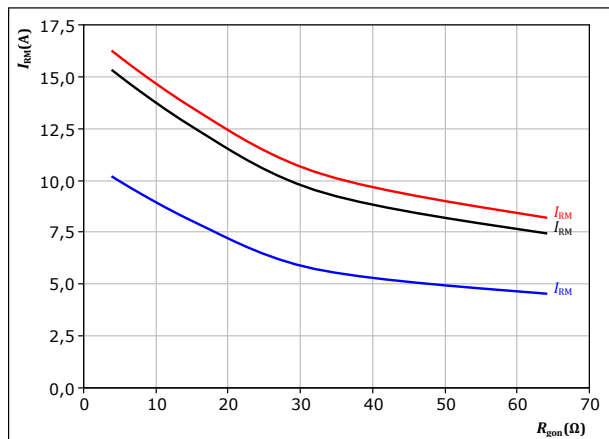

With an inductive load at

$V_{CE} = 400$ V
 $V_{GE} = 0/15$ V
 $I_c = 40$ A

T_j : — 25 °C
— 125 °C
— 150 °C



Brake Switching Characteristics

figure 49. FWD

Typical rate of fall of forward and reverse recovery current as a function of collector current
 $di_f/dt, di_{rr}/dt = f(I_c)$

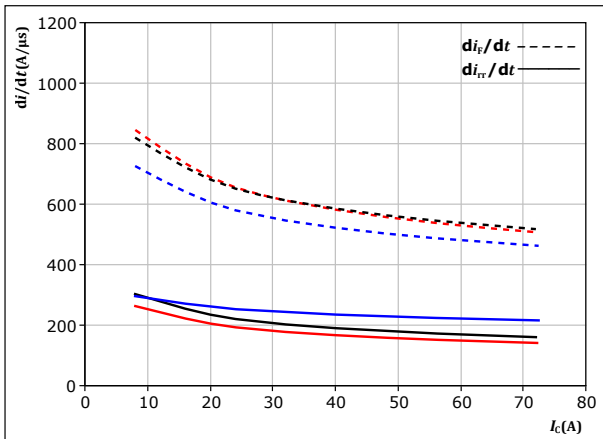

With an inductive load at
 $V_{CE} = 400$ V
 $V_{GE} = 0/15$ V
 $R_{gon} = 16$ Ω

T_j :
— 25 °C
— 125 °C
— 150 °C

figure 50. FWD

Typical rate of fall of forward and reverse recovery current as a function of turn on gate resistor
 $di_f/dt, di_{rr}/dt = f(R_{gon})$

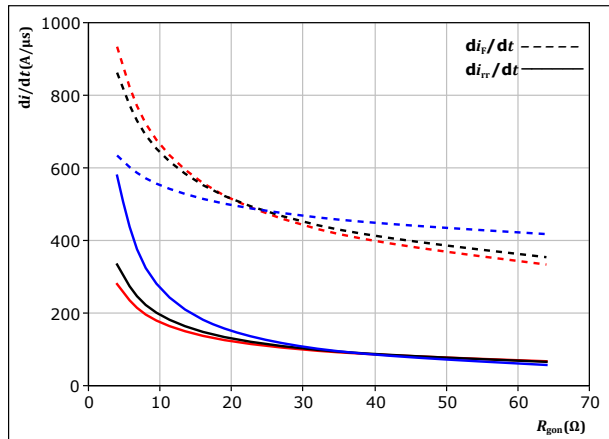

With an inductive load at
 $V_{CE} = 400$ V
 $V_{GE} = 0/15$ V
 $I_c = 40$ A

T_j :
— 25 °C
— 125 °C
— 150 °C

figure 51. IGBT

Reverse bias safe operating area

$I_c = f(V_{CE})$

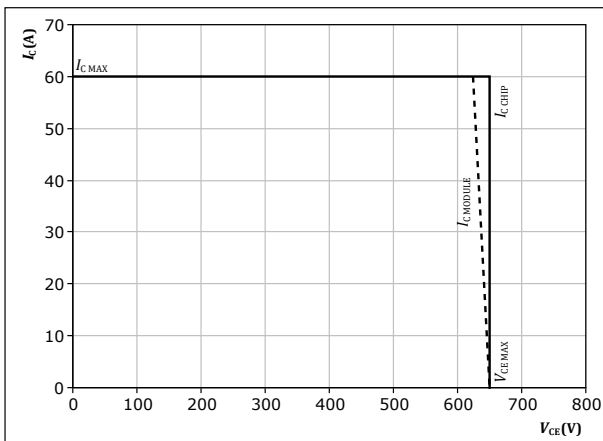

At $T_j = 150$ °C
 $R_{gon} = 16$ Ω
 $R_{goff} = 16$ Ω



Switching Definitions

figure 52. IGBT

Turn-off Switching Waveforms & definition of t_{doff} , t_{Eoff} (t_{Eoff} = integrating time for E_{off})

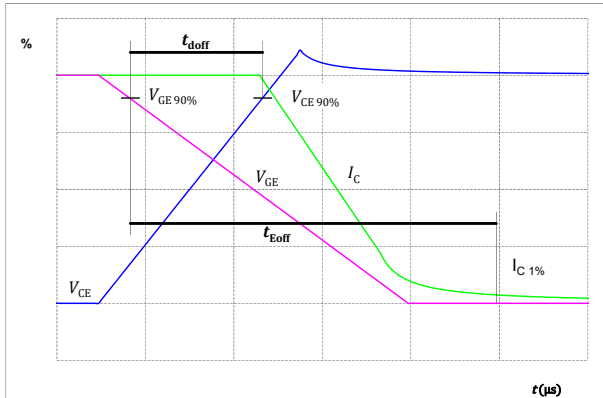

figure 53. IGBT

Turn-on Switching Waveforms & definition of t_{don} , t_{Eon} (t_{Eon} = integrating time for E_{on})

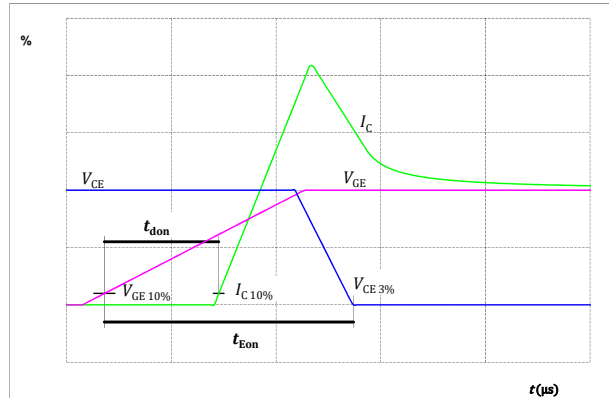

figure 54. IGBT

Turn-off Switching Waveforms & definition of t_f

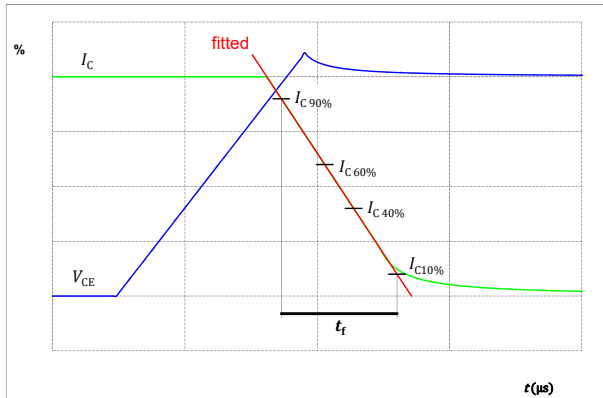
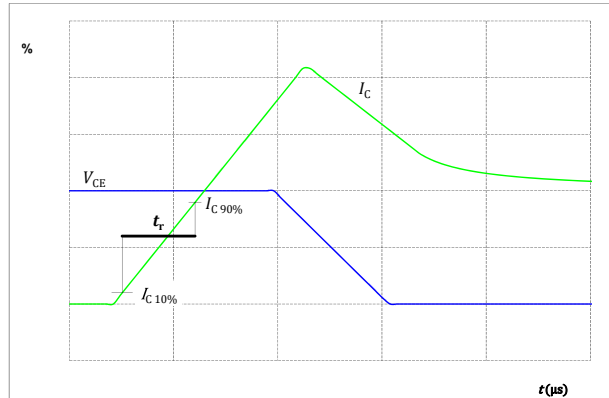

figure 55. IGBT

Turn-on Switching Waveforms & definition of t_r





Switching Definitions

figure 56. FWD

Turn-off Switching Waveforms & definition of t_{rr}

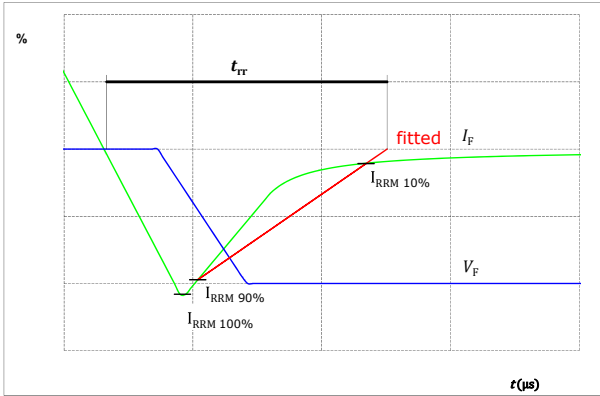
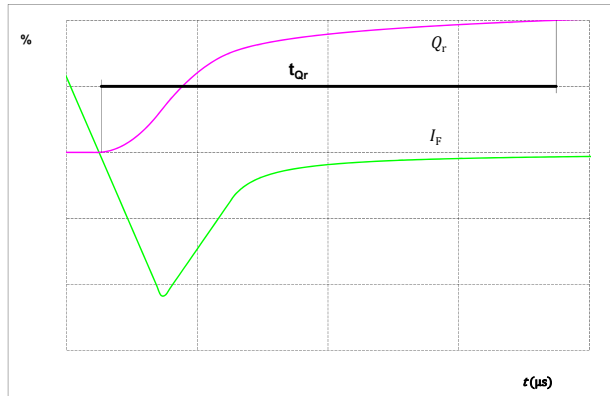

figure 57. FWD

Turn-on Switching Waveforms & definition of t_{Qr} (t_{Qr} = integrating time for Q_r)





Vincotech

10-FU07PMA030I7-P546B66
datasheet

Ordering Code	
Version	Ordering Code
Without thermal paste	10-FU07PMA030I7-P546B66
With thermal paste (5,2 W/mK, PTM6000HV)	10-FU07PMA030I7-P546B66-/-7/
With thermal paste (3,4 W/mK, PSX-P7)	10-FU07PMA030I7-P546B66-/-3/

Marking						
	Text	Name NN-NNNNNNNNNNNNNN- TTTTTIVV	Date code WWYY	UL & VIN UL VIN	Lot LLLLL	Serial SSSS
	Datamatrix	Type&Ver TTTTTIVV	Lot number LLLLL	Serial SSSS	Date code WWYY	

Outline			
Pin table [mm]			
Pin	X	Y	Function
1	25,5	2,7	Therm1
2	25,5	0	Therm2
3	22,8	0	DC-Rect
4	20,1	0	G27
5	16,2	0	DC-Br
6	13,5	0	G15
7	10,8	0	DC-3
8	8,1	0	G13
9	5,4	0	DC-2
10	2,7	0	G11
11	0	0	DC-1
12	0	19,8	G12
13	0	22,5	Ph1
14	7,5	19,8	G14
15	7,5	22,5	Ph2
16	15	19,8	G16
17	15	22,5	Ph3
18	22,8	22,5	DC+Inv
19	25,5	22,5	DC+Rect
20	33,5	22,5	Br
21	33,5	15	ACIn1
22	not assembled		
23	33,5	0	ACIn2

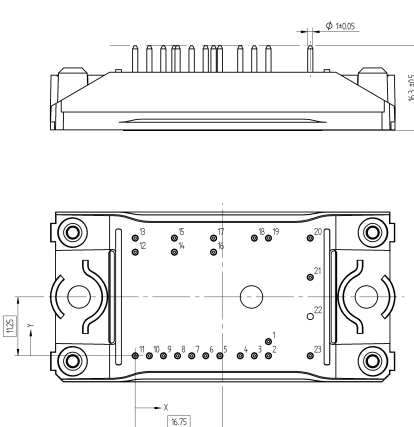

Tolerance of disposition: ±0.5mm at the end of pins
Dimension of coordinate axis is only offset without tolerance



Vincotech

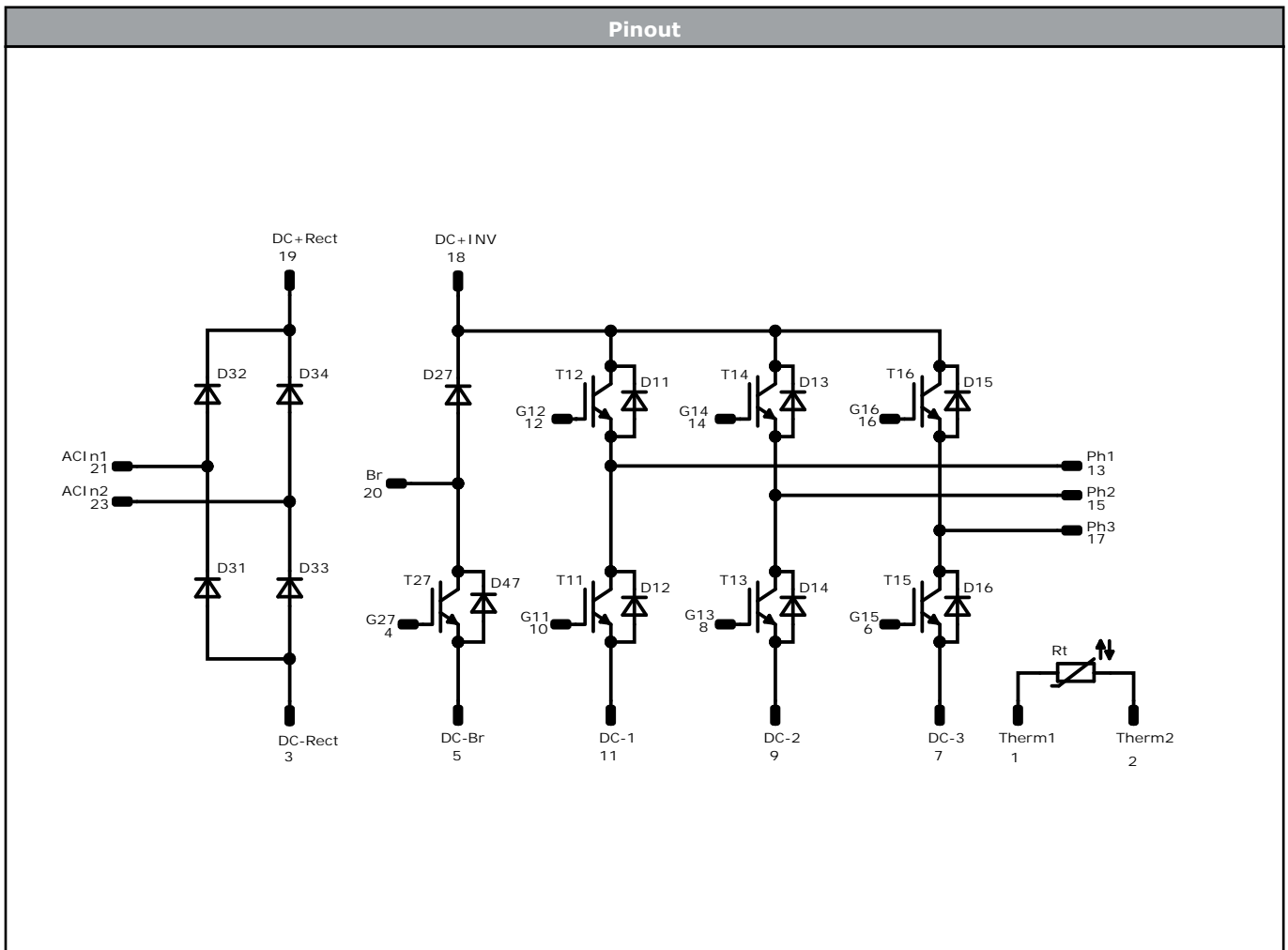

Identification					
ID	Component	Voltage	Current	Function	Comment
T11, T12, T13, T14, T15, T16	IGBT	650 V	30 A	Inverter Switch	
D11, D12, D13, D14, D15, D16	FWD	650 V	30 A	Inverter Diode	
T27	IGBT	650 V	30 A	Brake Switch	
D27	FWD	650 V	20 A	Brake Diode	
D47	FWD	650 V	20 A	Brake Sw. Protection Diode	
D31, D32, D33, D34	Rectifier	1600 V	35 A	Rectifier Diode	
Rt	Thermistor			Thermistor	



Packaging instruction				
Standard packaging quantity (SPQ) 135	>SPQ	Standard	<SPQ	Sample

Handling instruction
Handling instructions for <i>flow 0</i> packages see vincotech.com website.

Package data
Package data for <i>flow 0</i> packages see vincotech.com website.

Vincotech thermistor reference
See Vincotech thermistor reference table at vincotech.com website.

UL recognition and file number
This device is certified according to UL 1557 standard, UL file number E192116. For more information see vincotech.com website. 

Document No.:	Date:	Modification:	Pages
10-FU07PMA030I7-P546B66-D1-14	14 Dec. 2023		

DISCLAIMER

The information, specifications, procedures, methods and recommendations herein (together "information") are presented by Vincotech to reader in good faith, are believed to be accurate and reliable, but may well be incomplete and/or not applicable to all conditions or situations that may exist or occur. Vincotech reserves the right to make any changes without further notice to any products to improve reliability, function or design. No representation, guarantee or warranty is made to reader as to the accuracy, reliability or completeness of said information or that the application or use of any of the same will avoid hazards, accidents, losses, damages or injury of any kind to persons or property or that the same will not infringe third parties rights or give desired results. It is reader's sole responsibility to test and determine the suitability of the information and the product for reader's intended use.

LIFE SUPPORT POLICY

Vincotech products are not authorised for use as critical components in life support devices or systems without the express written approval of Vincotech.

As used herein:

1. Life support devices or systems are devices or systems which, (a) are intended for surgical implant into the body, or (b) support or sustain life, or (c) whose failure to perform when properly used in accordance with instructions for use provided in labelling can be reasonably expected to result in significant injury to the user.
2. A critical component is any component of a life support device or system whose failure to perform can be reasonably expected to cause the failure of the life support device or system, or to affect its safety or effectiveness.