



flowNPC 2

950 V / 400 A

Topology features

- Low side Kelvin Emitter for improved switching performance
- Neutral Point Clamped Topology (I-Type)
- Split topology
- Temperature sensor

Component features

- Low collector emitter saturation voltage
- High speed and smooth switching

Housing features

- Base isolation: AlN
- Convex shaped baseplate for superior thermal contact
- Cu baseplate
- Thermo-mechanical push-and-pull force relief
- Solder pin

Target applications

- Solar Inverters

Types

- 30-FT10NIA400S701-LP59F06

flow 2 13 mm housing

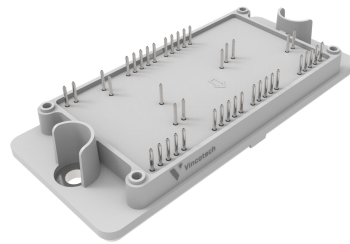

Schematic

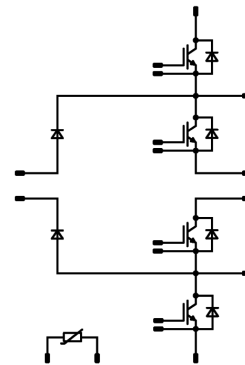



Vincotech

Maximum Ratings

$T_j = 25\text{ °C}$, unless otherwise specified

Parameter	Symbol	Conditions	Value	Unit
Buck Switch				
Collector-emitter voltage	V_{CES}		950	V
Collector current (DC current)	I_C	$T_j = T_{jmax}$ $T_s = 80\text{ °C}$	319	A
Repetitive peak collector current	I_{CRM}	t_p limited by T_{jmax}	800	A
Total power dissipation	P_{tot}	$T_j = T_{jmax}$ $T_s = 80\text{ °C}$	611	W
Gate-emitter voltage	V_{GES}		± 20	V
Maximum junction temperature	T_{jmax}		175	°C
Buck Diode				
Peak repetitive reverse voltage	V_{RRM}		1200	V
Forward current (DC current)	I_F	$T_j = T_{jmax}$ $T_s = 80\text{ °C}$	141	A
Surge (non-repetitive) forward current	I_{FSM}	Single Half Sine Wave, $t_p = 10\text{ ms}$ $T_j = 150\text{ °C}$	715	A
Surge current capability	I^2t		2550	A ² s
Total power dissipation	P_{tot}	$T_j = T_{jmax}$ $T_s = 80\text{ °C}$	325	W
Maximum junction temperature	T_{jmax}		175	°C
Boost Switch				
Collector-emitter voltage	V_{CES}		950	V
Collector current (DC current)	I_C	$T_j = T_{jmax}$ $T_s = 80\text{ °C}$	424	A
Repetitive peak collector current	I_{CRM}	t_p limited by T_{jmax}	800	A
Total power dissipation	P_{tot}	$T_j = T_{jmax}$ $T_s = 80\text{ °C}$	536	W
Gate-emitter voltage	V_{GES}		± 20	V
Maximum junction temperature	T_{jmax}		175	°C

**Maximum Ratings** $T_j = 25\text{ °C}$, unless otherwise specified

Parameter	Symbol	Conditions	Value	Unit
Boost Diode				
Peak repetitive reverse voltage	V_{RRM}		950	V
Forward current (DC current)	I_F	$T_j = T_{jmax}$ $T_s = 80\text{ °C}$	140	A
Repetitive peak forward current	I_{FRM}	t_p limited by T_{jmax}	400	A
Total power dissipation	P_{tot}	$T_j = T_{jmax}$ $T_s = 80\text{ °C}$	279	W
Maximum junction temperature	T_{jmax}		175	°C

Boost Sw. Inv. Diode

Peak repetitive reverse voltage	V_{RRM}		950	V
Forward current (DC current)	I_F	$T_j = T_{jmax}$ $T_s = 80\text{ °C}$	140	A
Repetitive peak forward current	I_{FRM}	t_p limited by T_{jmax}	400	A
Total power dissipation	P_{tot}	$T_j = T_{jmax}$ $T_s = 80\text{ °C}$	279	W
Maximum junction temperature	T_{jmax}		175	°C

Module Properties**Thermal Properties**

Storage temperature	T_{stg}		-40...+125	°C
Operation temperature under switching condition	T_{jop}		-40...+($T_{jmax} - 25$)	°C

Isolation Properties

Isolation voltage	V_{isol}	DC Test Voltage* $t_p = 2\text{ s}$	6000	V
Creepage distance			>12,7	mm
Clearance			>12,7	mm
Comparative Tracking Index	CTI		≥ 600	

*100 % tested in production



Vincotech

Characteristic Values

Parameter	Symbol	Conditions					Values			Unit
		V_{GS} [V]	V_{GE} [V]	V_{DS} [V]	I_D [A]	T_j [°C]	Min	Typ	Max	

Buck Switch

Static

Gate-emitter threshold voltage	$V_{GE(th)}$	$V_{CE} = V_{GE}$			0,00668	25	4,35	5,1	5,85	V
Collector-emitter saturation voltage	$V_{CE(sat)}$		15		400	25 125 150		1,67 1,94 2,01	2,35 ⁽¹⁾	V
Collector-emitter cut-off current	I_{CES}		0	950		25			8	μA
Gate-emitter leakage current	I_{GES}		20	0		25			400	nA
Internal gate resistance	r_g							0,375		Ω
Input capacitance	C_{ies}							26000		pF
Output capacitance	C_{oes}	$f = 100$ kHz	0	25		25		556		pF
Reverse transfer capacitance	C_{res}							80		pF
Gate charge	Q_g		±15		0	25		920		nC

Thermal

Thermal resistance junction to sink ⁽²⁾	$R_{th(j-s)}$	$\lambda_{paste} = 3,4$ W/mK (PSX)						0,16		K/W
--	---------------	---------------------------------------	--	--	--	--	--	------	--	-----

Dynamic

Turn-on delay time	$t_{d(on)}$					25 125 150		139,85 141,27 141,53		ns
Rise time	t_r					25 125 150		27,94 29,79 30,14		ns
Turn-off delay time	$t_{d(off)}$					25 125 150		122,56 146,8 153,43		ns
Fall time	t_f					25 125 150		27,45 45,51 51,93		ns
Turn-on energy (per pulse)	E_{on}	$Q_{tFWD} = 0,975$ μC $Q_{tFWD} = 1,01$ μC $Q_{tFWD} = 1,07$ μC				25 125 150		9,42 9,56 9,69		mWs
Turn-off energy (per pulse)	E_{off}					25 125 150		10,38 17,96 20,25		mWs



Vincotech

Characteristic Values

Parameter	Symbol	Conditions					Values			Unit
		V_{GE} [V] V_{GS} [V]	V_{CE} [V] V_{DS} [V] V_F [V]	I_C [A] I_D [A] I_F [A]	T_j [°C]	Min	Typ	Max		

Buck Diode

Static

Forward voltage	V_F				100	25 125 150		1,44 1,71 1,81	1,6 ⁽¹⁾	V
Reverse leakage current	I_R	$V_r = 1200$ V				25 150		1 70	400	μA

Thermal

Thermal resistance junction to sink ⁽²⁾	$R_{th(j-s)}$	$\lambda_{paste} = 3,4$ W/mK (PSX)						0,29		K/W
--	---------------	---------------------------------------	--	--	--	--	--	------	--	-----

Dynamic

Peak recovery current	I_{RM}					25 125 150		89,49 92,42 93,12		A
Reverse recovery time	t_{rr}					25 125 150		18,47 18,7 19,91		ns
Recovered charge	Q_r	$di/dt=8622$ A/μs $di/dt=9063$ A/μs $di/dt=9748$ A/μs	±15	600	400	25 125 150		0,975 1,01 1,07		μC
Reverse recovered energy	E_{rec}					25 125 150		0,2 0,215 0,234		mWs
Peak rate of fall of recovery current	$(di_r/dt)_{max}$					25 125 150		13105,2 13542,13 14636,48		A/μs



Vincotech

Characteristic Values

Parameter	Symbol	Conditions					Values			Unit
		V_{GS} [V]	V_{GE} [V]	V_{DS} [V]	I_D [A]	T_j [°C]	Min	Typ	Max	

Boost Switch

Static

Gate-emitter threshold voltage	$V_{GE(th)}$	$V_{CE} = V_{GE}$			0,0065	25	4,15	4,85	5,65	V
Collector-emitter saturation voltage	$V_{CE(sat)}$		15		400	25 125 150		1,21 1,23 1,24	1,4 ⁽¹⁾	V
Collector-emitter cut-off current	I_{CES}		0	950		25			8	μA
Gate-emitter leakage current	I_{GES}		20	0		25			200	nA
Internal gate resistance	r_g							0,75		Ω
Input capacitance	C_{ies}							49200		pF
Output capacitance	C_{oes}	$f = 100$ kHz	0	25		25		530		pF
Reverse transfer capacitance	C_{res}							220		pF
Gate charge	Q_g		±15		0	25		4100		nC

Thermal

Thermal resistance junction to sink ⁽²⁾	$R_{th(j-s)}$	$\lambda_{paste} = 3,4$ W/mK (PSX)						0,18		K/W
--	---------------	------------------------------------	--	--	--	--	--	------	--	-----

Dynamic

Turn-on delay time	$t_{d(on)}$					25 125 150		350,79 357,58 359,52		ns
Rise time	t_r					25 125 150		33,96 37,07 38,17		ns
Turn-off delay time	$t_{d(off)}$					25 125 150		323,89 373,74 386,34		ns
Fall time	t_f					25 125 150		263,26 364,29 383,57		ns
Turn-on energy (per pulse)	E_{on}	$Q_{tFWD} = 6,17$ μC $Q_{tFWD} = 15,31$ μC $Q_{tFWD} = 18,06$ μC				25 125 150		8,2 10,02 10,86		mWs
Turn-off energy (per pulse)	E_{off}					25 125 150		50,11 71,74 76,66		mWs



Vincotech

30-FT10NIA400S701-LP59F06
datasheet

Characteristic Values

Parameter	Symbol	Conditions					Values			Unit
		V_{GE} [V] V_{GS} [V]	V_{CE} [V] V_{DS} [V] V_F [V]	I_C [A] I_D [A] I_F [A]	T_j [°C]	Min	Typ	Max		
Boost Diode										
Static										
Forward voltage	V_F			200	25 125 150	2,1	2,64 2,44 2,36	2,8 ⁽¹⁾		V
Reverse leakage current	I_R	$V_r = 950$ V			25			8		μA
Thermal										
Thermal resistance junction to sink ⁽²⁾	$R_{th(j-s)}$	$\lambda_{paste} = 3,4$ W/mK (PSX)					0,34			K/W
Dynamic										
Peak recovery current	I_{RM}	$di/dt=10226$ A/μs $di/dt=9659$ A/μs $di/dt=9779$ A/μs	±15	600	400	25	209,43		A	
Reverse recovery time	t_{rr}					125	261,92			
						150	279,24			
						25	56,49			
Recovered charge	Q_r					125	164,87			ns
						150	182,42			
		25	6,17							
Reverse recovered energy	E_{rec}	125	15,31		μC					
		150	18,06							
		25	2,5							
Peak rate of fall of recovery current	$(di_r/dt)_{max}$	125	6,62		mWs					
		150	7,85							
		25	7421,55							
						125	7019,14		A/μs	
						150	6599,04			



Vincotech

Characteristic Values

Parameter	Symbol	Conditions					Values			Unit
		V_{GE} [V] V_{GS} [V]	V_{CE} [V] V_{DS} [V] V_F [V]	I_C [A] I_D [A] I_F [A]	T_j [°C]	Min	Typ	Max		

Boost Sw. Inv. Diode

Static

Forward voltage	V_F				200	25 125 150	2,1	2,64 2,44 2,36	2,8 ⁽¹⁾	V
Reverse leakage current	I_R	$V_r = 950$ V				25			8	μA

Thermal

Thermal resistance junction to sink ⁽²⁾	$R_{th(j-s)}$	$\lambda_{paste} = 3,4$ W/mK (PSX)						0,34		K/W
--	---------------	---------------------------------------	--	--	--	--	--	------	--	-----

Thermistor

Static

Rated resistance	R					25		22		kΩ
Deviation of R100	$\Delta_{R/R}$	$R_{100} = 1484$ Ω				100	-5		5	%
Power dissipation	P					25		130		mW
Power dissipation constant	d					25		1,5		mW/K
B-value	$B_{(25/50)}$	Tol. ±1 %						3962		K
B-value	$B_{(25/100)}$	Tol. ±1 %						4000		K
Vincotech Thermistor Reference									I	

⁽¹⁾ Value at chip level

⁽²⁾ Only valid with pre-applied Vincotech thermal interface material.



Buck Switch Characteristics

figure 1. IGBT

Typical output characteristics

$$I_C = f(V_{CE})$$

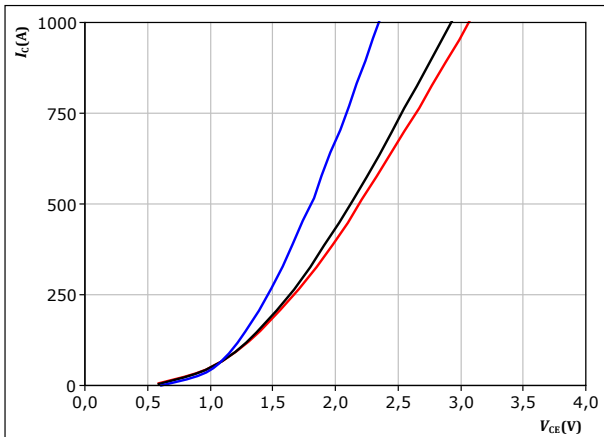

$t_p = 250 \mu s$
 $V_{GE} = 15 V$

T_j : 25 °C (blue), 125 °C (black), 150 °C (red)

figure 2. IGBT

Typical output characteristics

$$I_C = f(V_{CE})$$

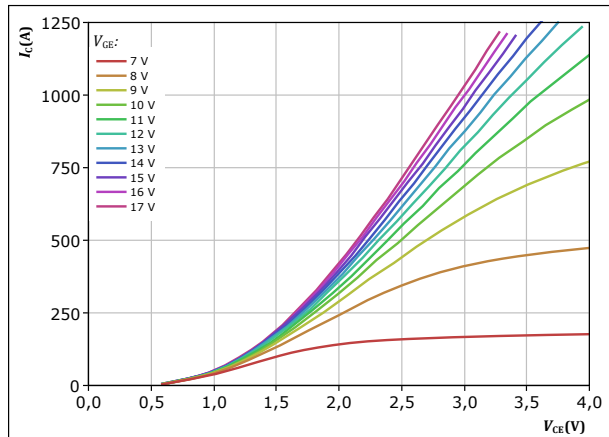

$t_p = 250 \mu s$
 $T_j = 150 \text{ °C}$
 V_{GE} from 7 V to 17 V in steps of 1 V

figure 3. IGBT

Typical transfer characteristics

$$I_C = f(V_{GE})$$

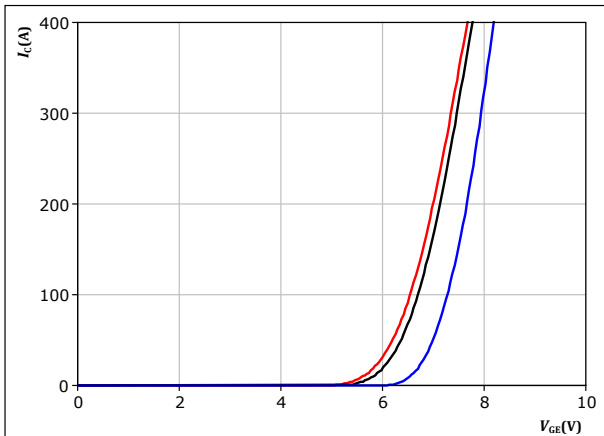

$t_p = 250 \mu s$
 $V_{CE} = 10 V$

T_j : 25 °C (blue), 125 °C (black), 150 °C (red)

figure 4. IGBT

Transient thermal impedance as a function of pulse width

$$Z_{th(j-s)} = f(t_p)$$

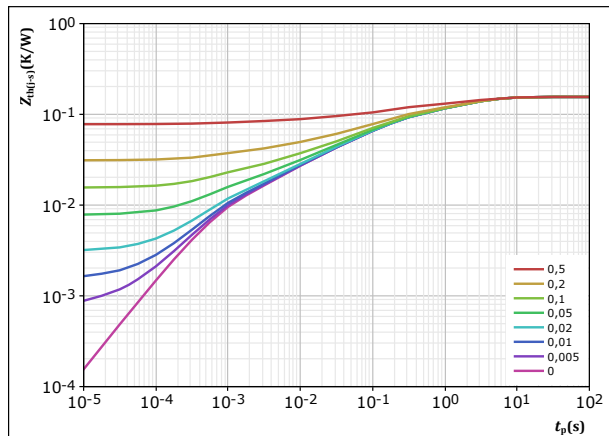

$D = t_p / T$
 $R_{th(j-s)} = 0,156 K/W$

IGBT thermal model values

R (K/W)	τ (s)
3,83E-02	3,47E+00
3,82E-02	7,68E-01
5,06E-02	1,03E-01
1,90E-02	9,60E-03
9,58E-03	7,32E-04



Buck Switch Characteristics

figure 5. IGBT

Safe operating area

$$I_C = f(V_{CE})$$

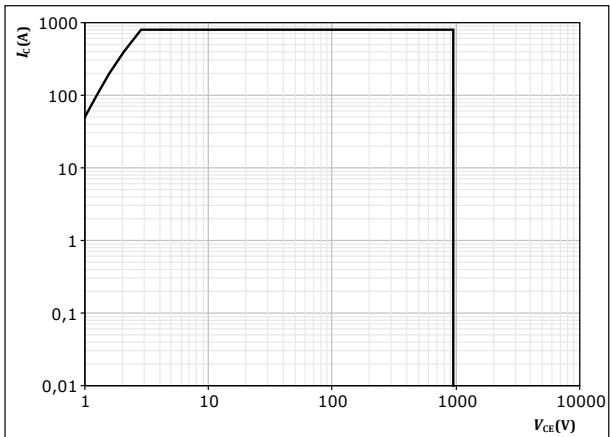

D = single pulse
T_s = 80 °C
V_{CE} = 15 V
T_j = T_{jmax}



Buck Diode Characteristics

figure 6. FWD

Typical forward characteristics

$$I_F = f(V_F)$$

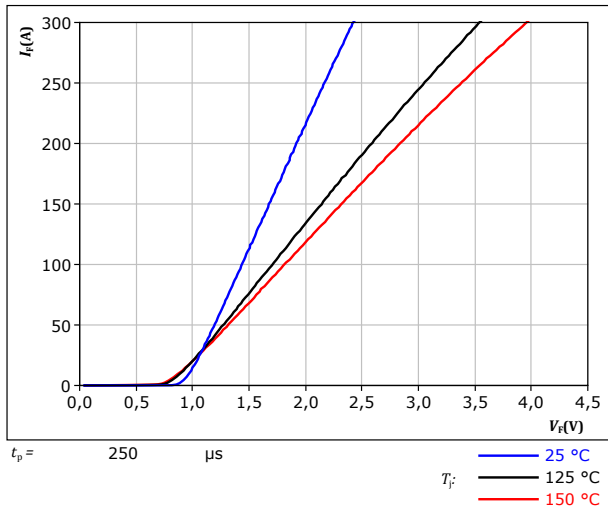
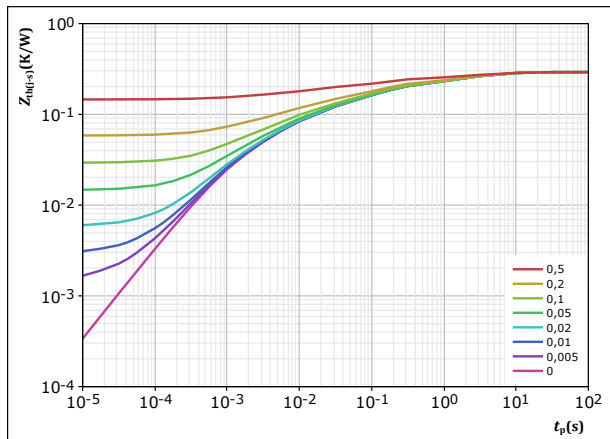

figure 7. FWD

Transient thermal impedance as a function of pulse width

$$Z_{th(j-s)} = f(t_p)$$



$D = t_p / T$
 $R_{th(j-s)} = 0,292$ K/W
 FWD thermal model values

R (K/W)	τ (s)
4,49E-02	5,08E+00
5,20E-02	1,22E+00
9,84E-02	1,03E-01
6,95E-02	8,82E-03
2,71E-02	1,08E-03



Boost Switch Characteristics

figure 8. IGBT

Typical output characteristics

$I_C = f(V_{CE})$

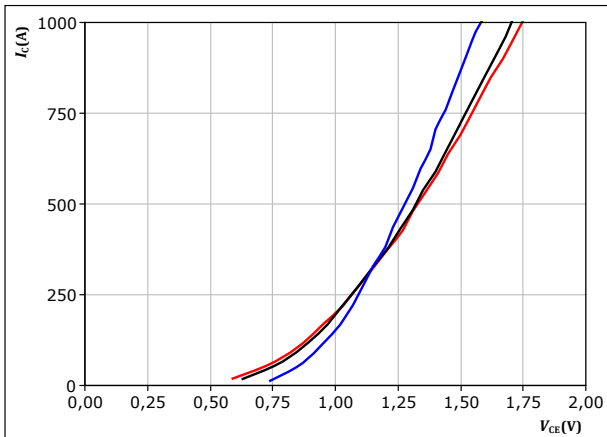

$t_p = 250 \mu s$
 $V_{GE} = 15 V$
 $T_j:$ 25 °C, 125 °C, 150 °C

figure 9. IGBT

Typical output characteristics

$I_C = f(V_{CE})$

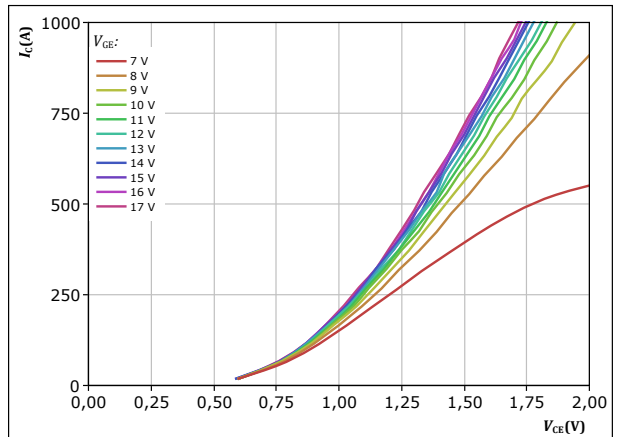

$t_p = 250 \mu s$
 $T_j = 150 \text{ °C}$
 V_{GE} from 7 V to 17 V in steps of 1 V

figure 10. IGBT

Typical transfer characteristics

$I_C = f(V_{GE})$

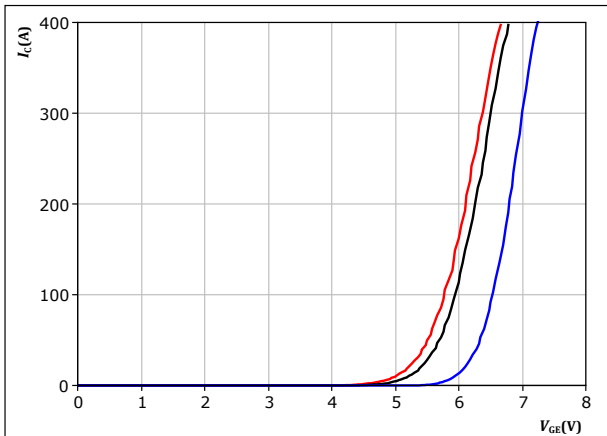

$t_p = 250 \mu s$
 $V_{CE} = 10 V$
 $T_j:$ 25 °C, 125 °C, 150 °C

figure 11. IGBT

Transient thermal impedance as a function of pulse width

$Z_{th(j-s)} = f(t_p)$

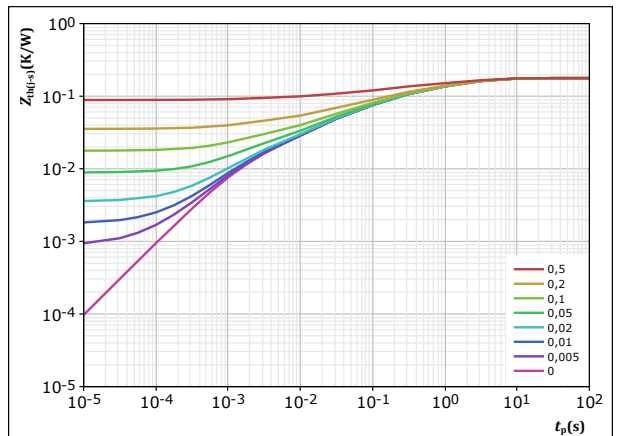

$D = t_p / T$
 $R_{th(j-s)} = 0,177 \text{ K/W}$
 IGBT thermal model values

R (K/W)	τ (s)
4,04E-02	3,18E+00
4,73E-02	7,03E-01
5,13E-02	1,16E-01
2,69E-02	1,67E-02
1,14E-02	1,50E-03



Boost Switch Characteristics

figure 12. IGBT

Safe operating area

$$I_C = f(V_{CE})$$

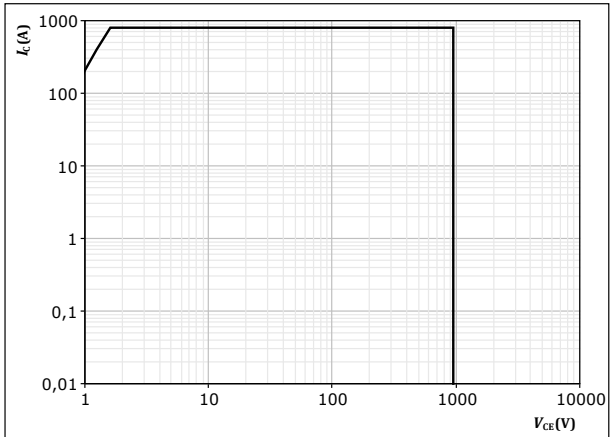

$D =$ single pulse
 $T_s = 80$ °C
 $V_{CE} = 15$ V
 $T_j = T_{jmax}$



Boost Diode Characteristics

figure 13. FWD

Typical forward characteristics

$$I_F = f(V_F)$$

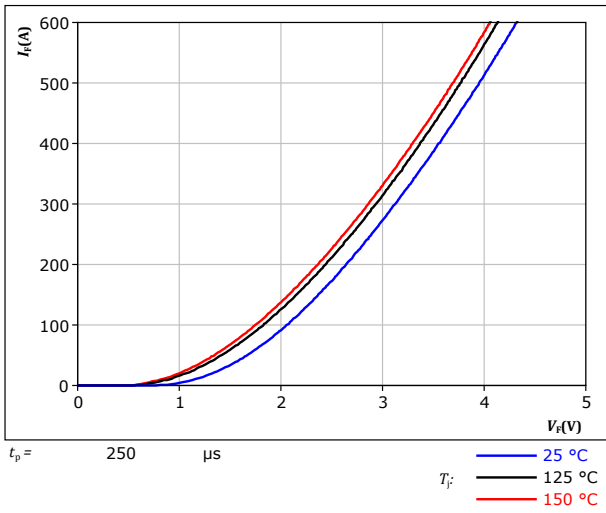
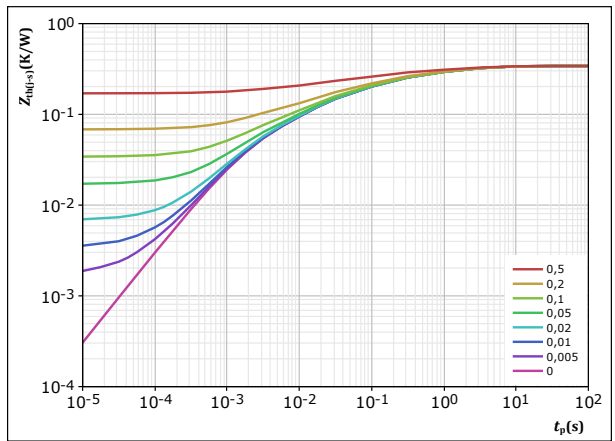

figure 14. FWD

Transient thermal impedance as a function of pulse width

$$Z_{th(j-s)} = f(t_p)$$



$D = t_p / T$
 $R_{th(j-s)} = 0,341 \text{ K/W}$
 FWD thermal model values

R (K/W)	τ (s)
4,43E-02	3,49E+00
7,04E-02	6,20E-01
1,03E-01	9,42E-02
8,39E-02	1,36E-02
3,93E-02	1,70E-03



Boost Sw. Inv. Diode Characteristics

figure 15. FWD

Typical forward characteristics

$$I_F = f(V_F)$$

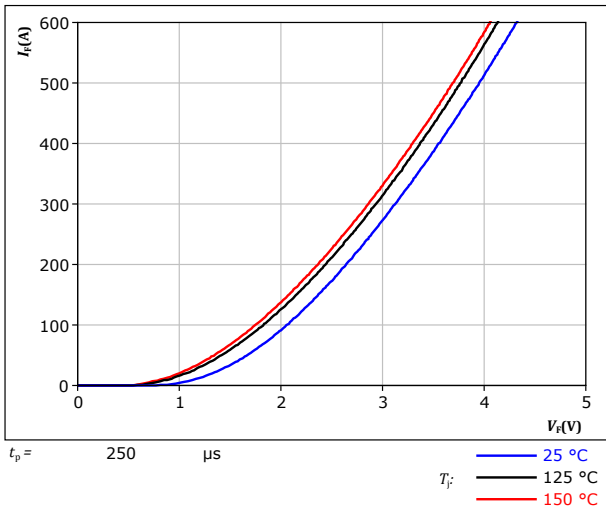
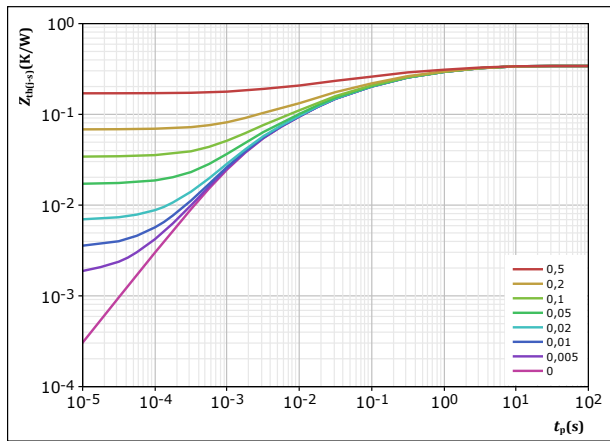

figure 16. FWD

Transient thermal impedance as a function of pulse width

$$Z_{th(j-s)} = f(t_p)$$



$D = t_p / T$
 $R_{th(j-s)} = 0,341 \text{ K/W}$
 FWD thermal model values

R (K/W)	τ (s)
4,43E-02	3,49E+00
7,04E-02	6,20E-01
1,03E-01	9,42E-02
8,39E-02	1,36E-02
3,93E-02	1,70E-03



Thermistor Characteristics

figure 17. Thermistor

Typical NTC characteristic as function of temperature

$$R_T = f(T)$$

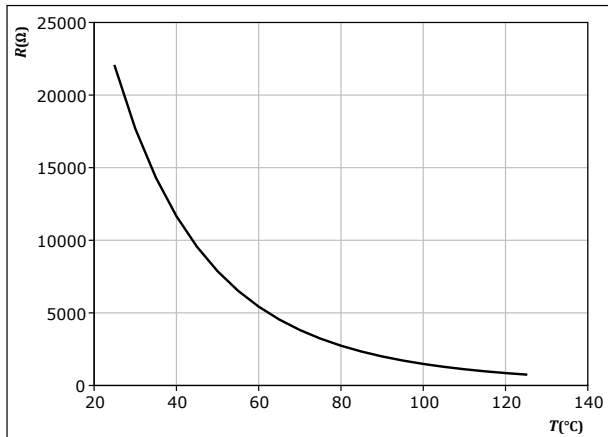



Buck Switching Characteristics

figure 18. IGBT

Typical switching energy losses as a function of collector current
 $E = f(I_c)$

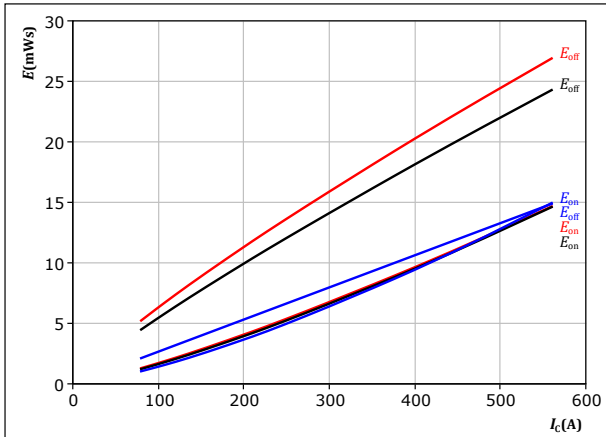

With an inductive load at

$V_{CE} = 600 \text{ V}$
 $V_{GE} = \pm 15 \text{ V}$
 $R_{gon} = 2 \text{ } \Omega$
 $R_{goff} = 2 \text{ } \Omega$

T_j : — 25 °C
 — 125 °C
 — 150 °C

figure 19. IGBT

Typical switching energy losses as a function of IGBT turn on gate resistor
 $E = f(R_g)$

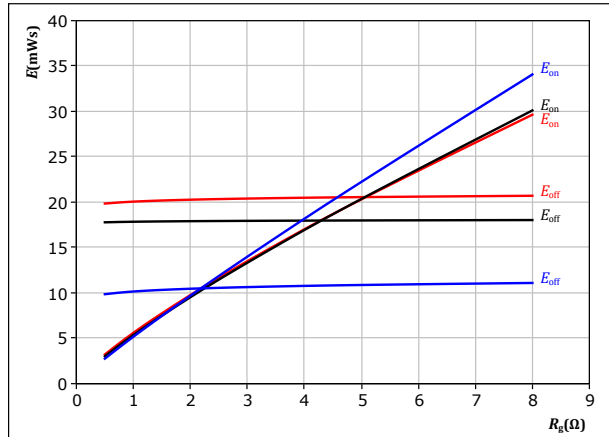

With an inductive load at

$V_{CE} = 600 \text{ V}$
 $V_{GE} = \pm 15 \text{ V}$
 $I_c = 400 \text{ A}$

T_j : — 25 °C
 — 125 °C
 — 150 °C

figure 20. FWD

Typical reverse recovered energy loss as a function of collector current
 $E_{rec} = f(I_c)$

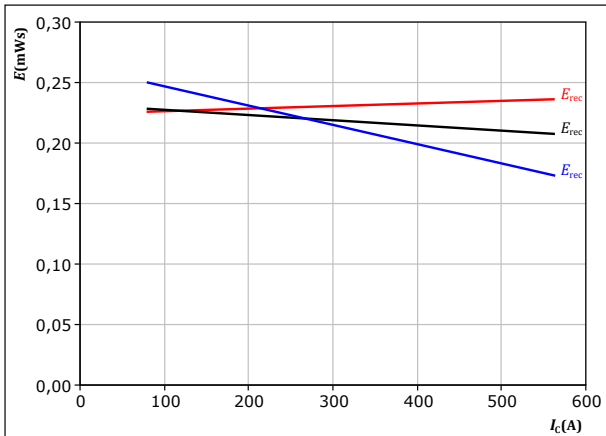

With an inductive load at

$V_{CE} = 600 \text{ V}$
 $V_{GE} = \pm 15 \text{ V}$
 $R_{gon} = 2 \text{ } \Omega$

T_j : — 25 °C
 — 125 °C
 — 150 °C

figure 21. FWD

Typical reverse recovered energy loss as a function of IGBT turn on gate resistor
 $E_{rec} = f(R_g)$

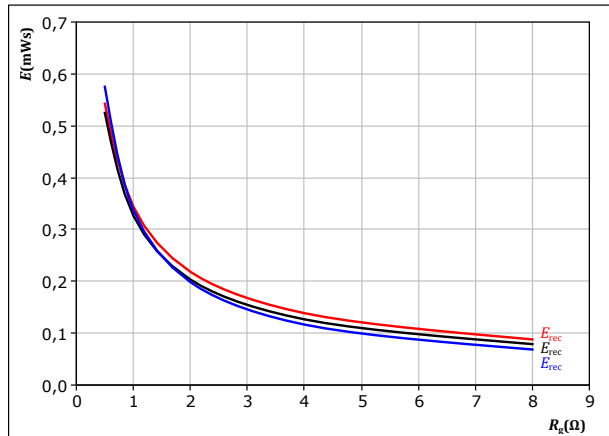

With an inductive load at

$V_{CE} = 600 \text{ V}$
 $V_{GE} = \pm 15 \text{ V}$
 $I_c = 400 \text{ A}$

T_j : — 25 °C
 — 125 °C
 — 150 °C



Buck Switching Characteristics

figure 22. IGBT

Typical switching times as a function of collector current
 $t = f(I_c)$

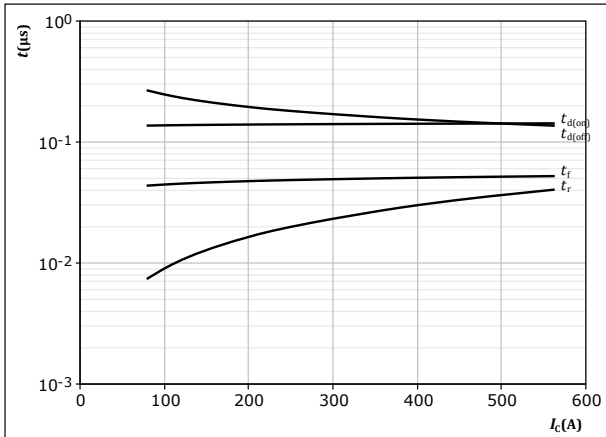

With an inductive load at
 $T_j = 150 \text{ }^\circ\text{C}$
 $V_{CE} = 600 \text{ V}$
 $V_{GE} = \pm 15 \text{ V}$
 $R_{gon} = 2 \text{ } \Omega$
 $R_{goff} = 2 \text{ } \Omega$

figure 23. IGBT

Typical switching times as a function of IGBT turn on gate resistor
 $t = f(R_g)$

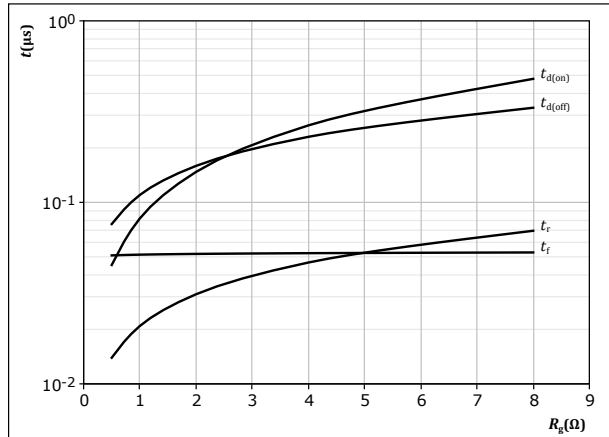

With an inductive load at
 $T_j = 150 \text{ }^\circ\text{C}$
 $V_{CE} = 600 \text{ V}$
 $V_{GE} = \pm 15 \text{ V}$
 $I_c = 400 \text{ A}$

figure 24. FWD

Typical reverse recovery time as a function of collector current
 $t_{rr} = f(I_c)$

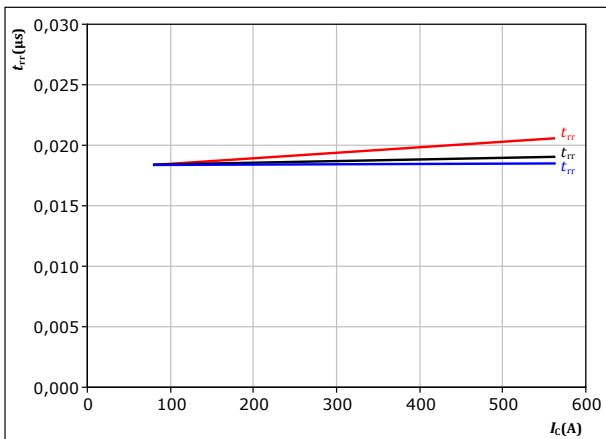

With an inductive load at
 $V_{CE} = 600 \text{ V}$
 $V_{GE} = \pm 15 \text{ V}$
 $R_{gon} = 2 \text{ } \Omega$
 $T_j:$ — 25 °C
— 125 °C
— 150 °C

figure 25. FWD

Typical reverse recovery time as a function of IGBT turn on gate resistor
 $t_{rr} = f(R_{gon})$

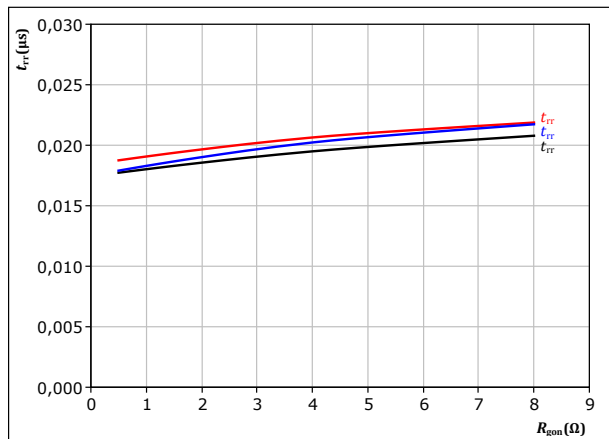

With an inductive load at
 $V_{CE} = 600 \text{ V}$
 $V_{GE} = \pm 15 \text{ V}$
 $I_c = 400 \text{ A}$
 $T_j:$ — 25 °C
— 125 °C
— 150 °C



Buck Switching Characteristics

figure 26. FWD

Typical recovered charge as a function of collector current

$$Q_r = f(I_c)$$

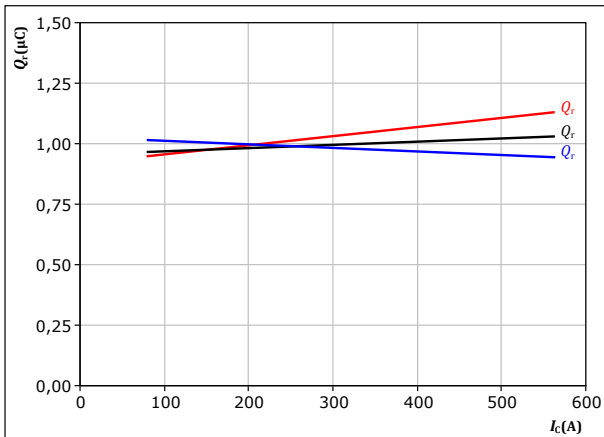

With an inductive load at

$V_{CE} = 600 \text{ V}$
 $V_{GE} = \pm 15 \text{ V}$
 $R_{gon} = 2 \ \Omega$

T_j : 25 °C
125 °C
150 °C

figure 27. FWD

Typical recovered charge as a function of IGBT turn on gate resistor

$$Q_r = f(R_{gon})$$

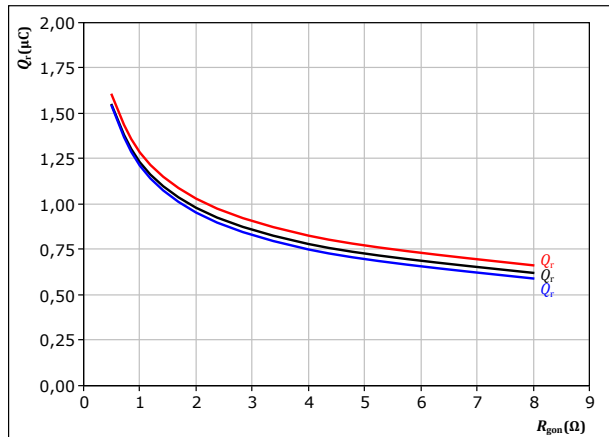

With an inductive load at

$V_{CE} = 600 \text{ V}$
 $V_{GE} = \pm 15 \text{ V}$
 $I_c = 400 \text{ A}$

T_j : 25 °C
125 °C
150 °C

figure 28. FWD

Typical peak reverse recovery current as a function of collector current

$$I_{RM} = f(I_c)$$

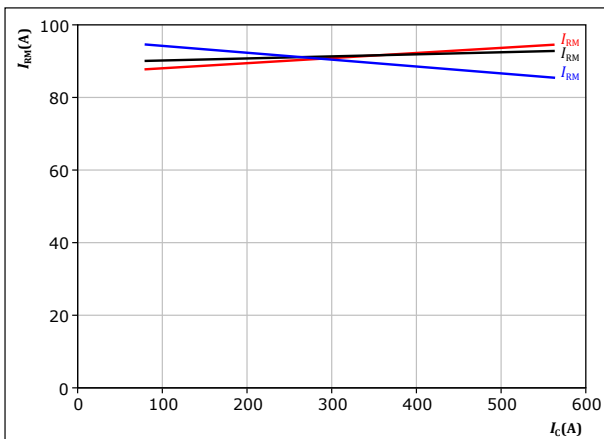

With an inductive load at

$V_{CE} = 600 \text{ V}$
 $V_{GE} = \pm 15 \text{ V}$
 $R_{gon} = 2 \ \Omega$

T_j : 25 °C
125 °C
150 °C

figure 29. FWD

Typical peak reverse recovery current as a function of IGBT turn on gate resistor

$$I_{RM} = f(R_{gon})$$

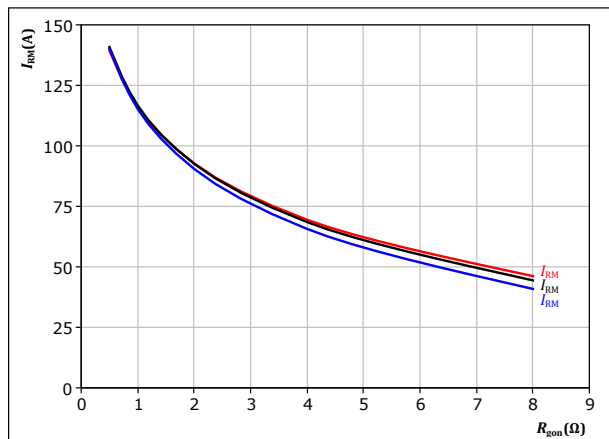

With an inductive load at

$V_{CE} = 600 \text{ V}$
 $V_{GE} = \pm 15 \text{ V}$
 $I_c = 400 \text{ A}$

T_j : 25 °C
125 °C
150 °C



Buck Switching Characteristics

figure 30. FWD

Typical rate of fall of forward and reverse recovery current as a function of collector current
 $di_f/dt, di_r/dt = f(I_c)$

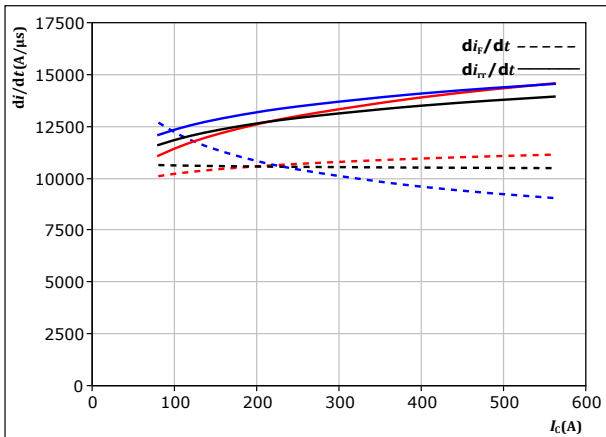

With an inductive load at

$V_{CE} = 600 \text{ V}$
 $V_{GE} = \pm 15 \text{ V}$
 $R_{gon} = 2 \text{ } \Omega$

T_j :
— 25 °C
— 125 °C
— 150 °C

figure 31. FWD

Typical rate of fall of forward and reverse recovery current as a function of turn on gate resistor
 $di_f/dt, di_r/dt = f(R_{gon})$

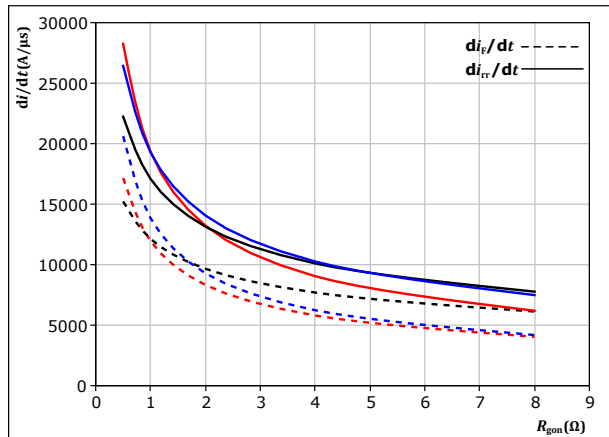

With an inductive load at

$V_{CE} = 600 \text{ V}$
 $V_{GE} = \pm 15 \text{ V}$
 $I_c = 400 \text{ A}$

T_j :
— 25 °C
— 125 °C
— 150 °C

figure 32. IGBT

Reverse bias safe operating area

$I_c = f(V_{CE})$

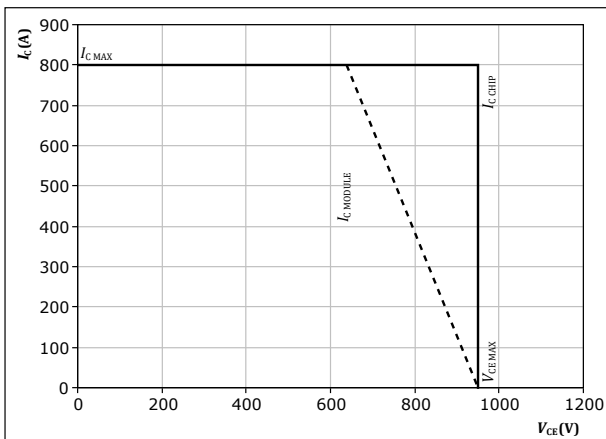

At $T_j = 150 \text{ } ^\circ\text{C}$
 $R_{gon} = 2 \text{ } \Omega$
 $R_{goff} = 2 \text{ } \Omega$



Boost Switching Characteristics

figure 33. IGBT

Typical switching energy losses as a function of collector current
 $E = f(I_c)$

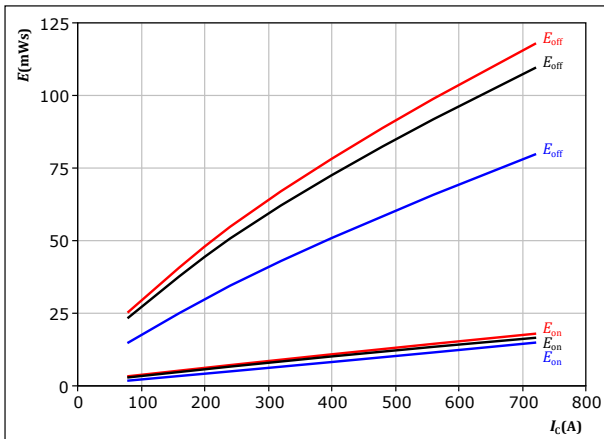

With an inductive load at
 $V_{CE} = 600$ V
 $V_{GE} = \pm 15$ V
 $R_{gon} = 2$ Ω
 $R_{goff} = 2$ Ω
 T_j : 25 °C (blue), 125 °C (black), 150 °C (red)

figure 34. IGBT

Typical switching energy losses as a function of IGBT turn on gate resistor
 $E = f(R_g)$

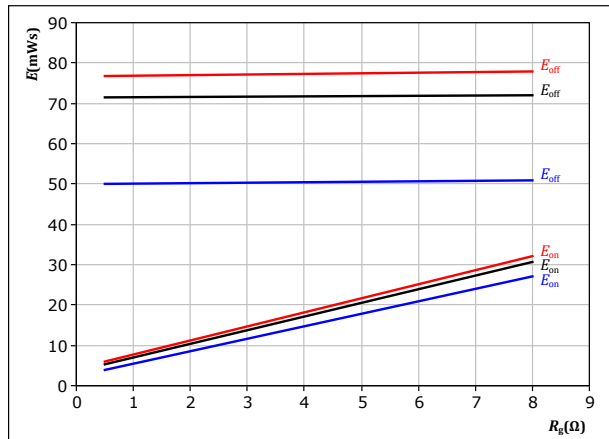

With an inductive load at
 $V_{CE} = 600$ V
 $V_{GE} = \pm 15$ V
 $I_c = 400$ A
 T_j : 25 °C (blue), 125 °C (black), 150 °C (red)

figure 35. FWD

Typical reverse recovered energy loss as a function of collector current
 $E_{rec} = f(I_c)$

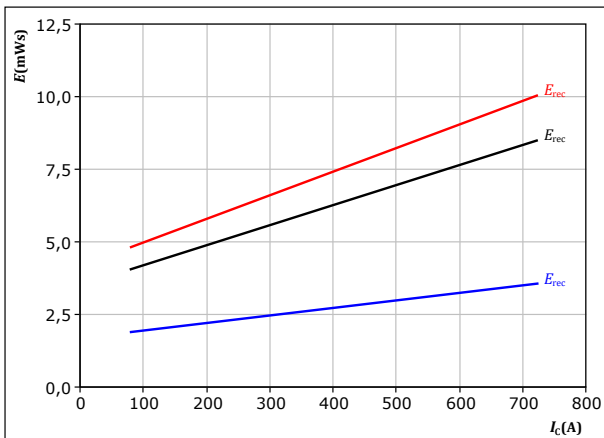

With an inductive load at
 $V_{CE} = 600$ V
 $V_{GE} = \pm 15$ V
 $R_{gon} = 2$ Ω
 T_j : 25 °C (blue), 125 °C (black), 150 °C (red)

figure 36. FWD

Typical reverse recovered energy loss as a function of IGBT turn on gate resistor
 $E_{rec} = f(R_g)$

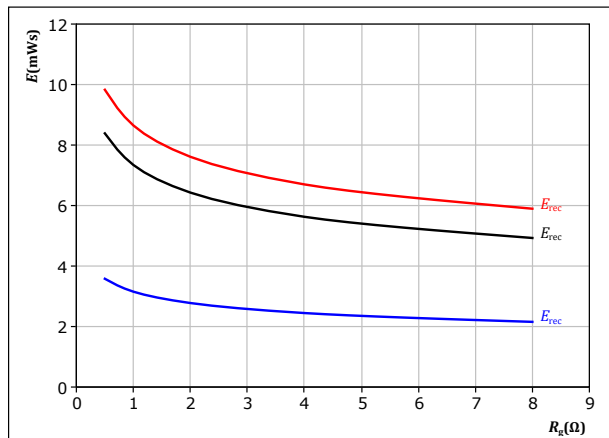

With an inductive load at
 $V_{CE} = 600$ V
 $V_{GE} = \pm 15$ V
 $I_c = 400$ A
 T_j : 25 °C (blue), 125 °C (black), 150 °C (red)



Boost Switching Characteristics

figure 37. IGBT

Typical switching times as a function of collector current
 $t = f(I_c)$

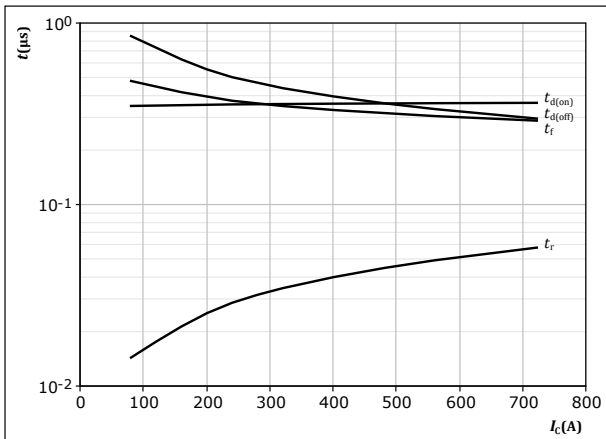

With an inductive load at

$T_j = 150 \text{ }^\circ\text{C}$
 $V_{CE} = 600 \text{ V}$
 $V_{GE} = \pm 15 \text{ V}$
 $R_{gon} = 2 \text{ } \Omega$
 $R_{goff} = 2 \text{ } \Omega$

figure 38. IGBT

Typical switching times as a function of IGBT turn on gate resistor
 $t = f(R_g)$

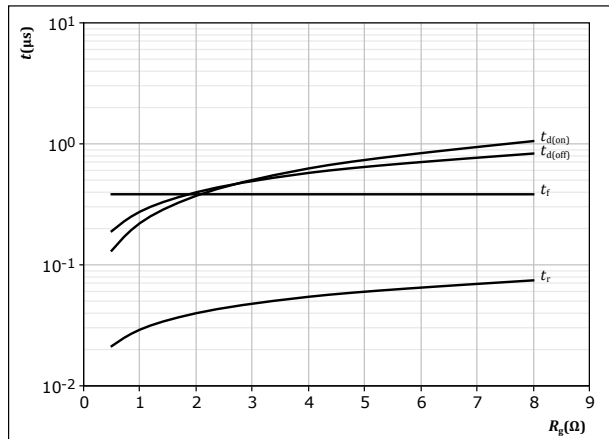

With an inductive load at

$T_j = 150 \text{ }^\circ\text{C}$
 $V_{CE} = 600 \text{ V}$
 $V_{GE} = \pm 15 \text{ V}$
 $I_c = 400 \text{ A}$

figure 39. FWD

Typical reverse recovery time as a function of collector current
 $t_{rr} = f(I_c)$

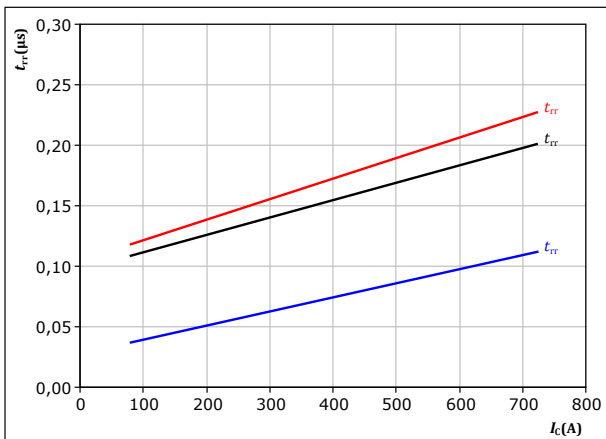

With an inductive load at

$V_{CE} = 600 \text{ V}$
 $V_{GE} = \pm 15 \text{ V}$
 $R_{gon} = 2 \text{ } \Omega$

T_j : — 25 °C
— 125 °C
— 150 °C

figure 40. FWD

Typical reverse recovery time as a function of IGBT turn on gate resistor
 $t_{rr} = f(R_{gon})$

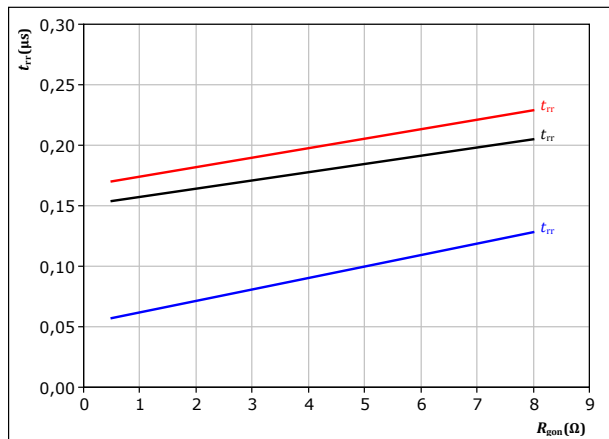

With an inductive load at

$V_{CE} = 600 \text{ V}$
 $V_{GE} = \pm 15 \text{ V}$
 $I_c = 400 \text{ A}$

T_j : — 25 °C
— 125 °C
— 150 °C



Boost Switching Characteristics

figure 41. FWD

Typical recovered charge as a function of collector current

$$Q_r = f(I_c)$$

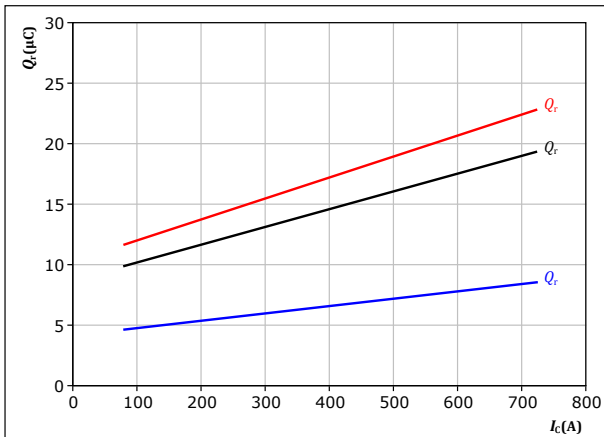

With an inductive load at

$V_{CE} = 600 \text{ V}$
 $V_{GE} = \pm 15 \text{ V}$
 $R_{gon} = 2 \ \Omega$

T_j : — 25 °C
— 125 °C
— 150 °C

figure 42. FWD

Typical recovered charge as a function of IGBT turn on gate resistor

$$Q_r = f(R_{gon})$$

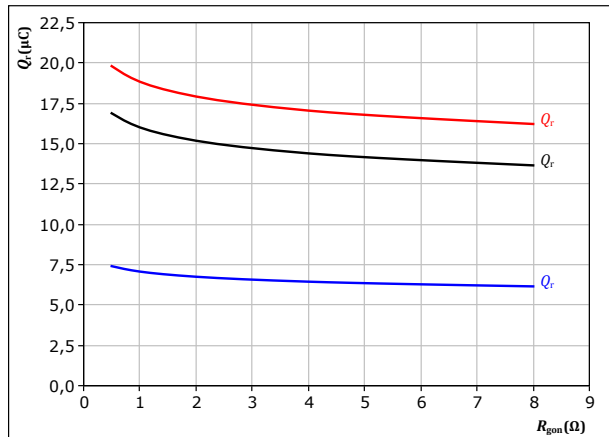

With an inductive load at

$V_{CE} = 600 \text{ V}$
 $V_{GE} = \pm 15 \text{ V}$
 $I_c = 400 \text{ A}$

T_j : — 25 °C
— 125 °C
— 150 °C

figure 43. FWD

Typical peak reverse recovery current as a function of collector current

$$I_{RM} = f(I_c)$$

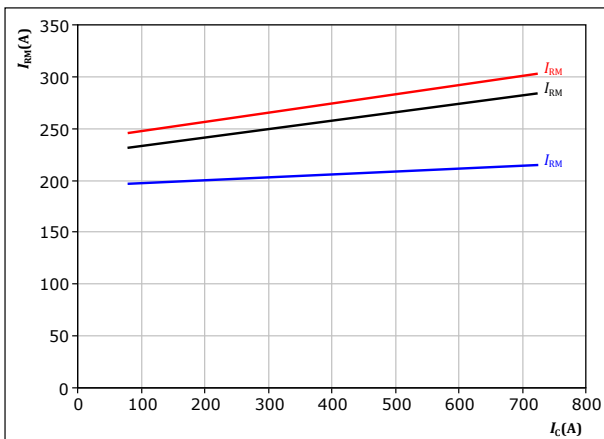

With an inductive load at

$V_{CE} = 600 \text{ V}$
 $V_{GE} = \pm 15 \text{ V}$
 $R_{gon} = 2 \ \Omega$

T_j : — 25 °C
— 125 °C
— 150 °C

figure 44. FWD

Typical peak reverse recovery current as a function of IGBT turn on gate resistor

$$I_{RM} = f(R_{gon})$$

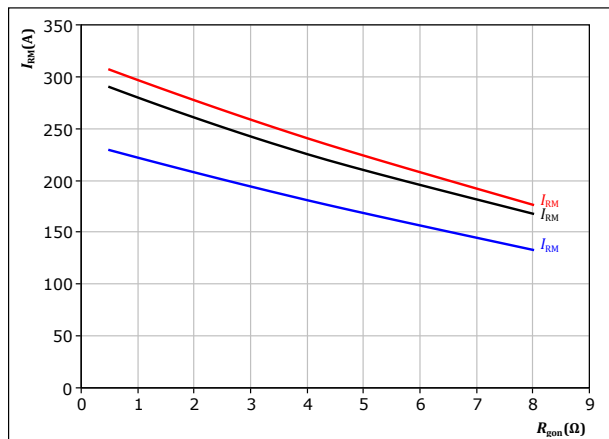

With an inductive load at

$V_{CE} = 600 \text{ V}$
 $V_{GE} = \pm 15 \text{ V}$
 $I_c = 400 \text{ A}$

T_j : — 25 °C
— 125 °C
— 150 °C



Boost Switching Characteristics

figure 45. FWD

Typical rate of fall of forward and reverse recovery current as a function of collector current
 $di_f/dt, di_r/dt = f(I_C)$

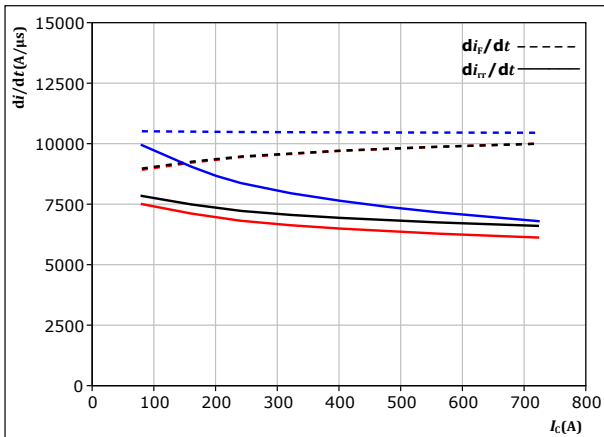

With an inductive load at

$V_{CE} = 600 \text{ V}$
 $V_{GE} = \pm 15 \text{ V}$
 $R_{gon} = 2 \text{ } \Omega$

T_j :
— 25 °C
— 125 °C
— 150 °C

figure 46. FWD

Typical rate of fall of forward and reverse recovery current as a function of turn on gate resistor
 $di_f/dt, di_r/dt = f(R_{gon})$

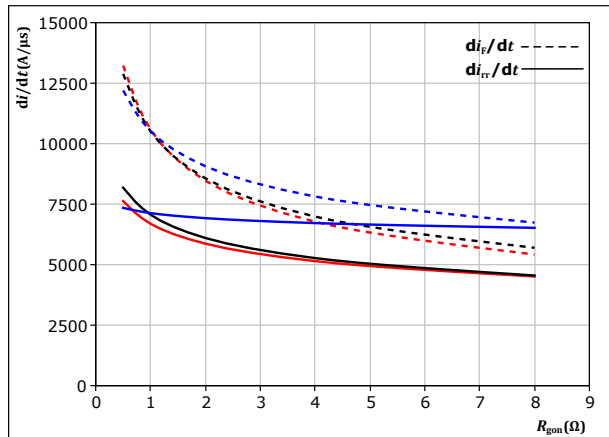

With an inductive load at

$V_{CE} = 600 \text{ V}$
 $V_{GE} = \pm 15 \text{ V}$
 $I_C = 400 \text{ A}$

T_j :
— 25 °C
— 125 °C
— 150 °C

figure 47. IGBT

Reverse bias safe operating area

$I_C = f(V_{CE})$

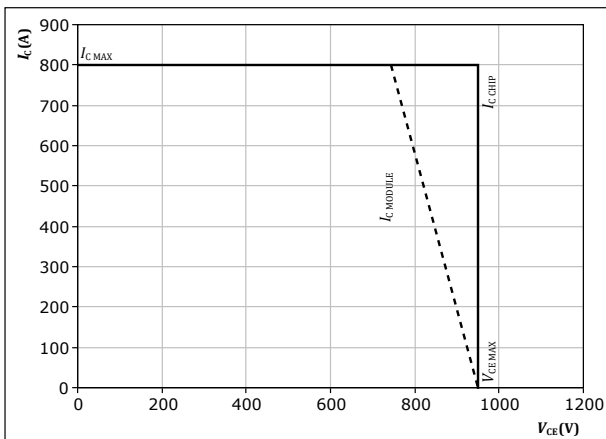

At $T_j = 150 \text{ } ^\circ\text{C}$
 $R_{gon} = 2 \text{ } \Omega$
 $R_{goff} = 2 \text{ } \Omega$



Switching Definitions

figure 48. IGBT

Turn-off Switching Waveforms & definition of t_{doff} , t_{Eoff} (t_{Eoff} = integrating time for E_{off})

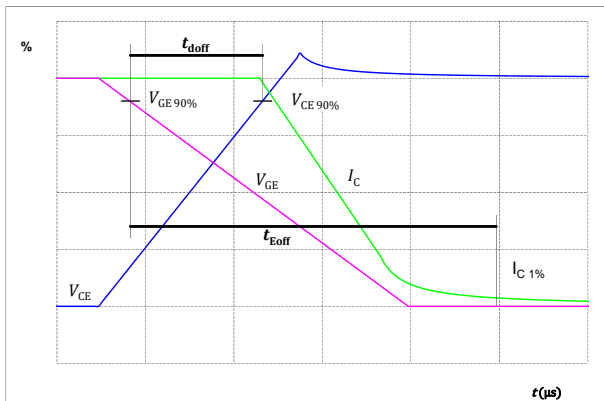

figure 49. IGBT

Turn-on Switching Waveforms & definition of t_{don} , t_{Eon} (t_{Eon} = integrating time for E_{on})

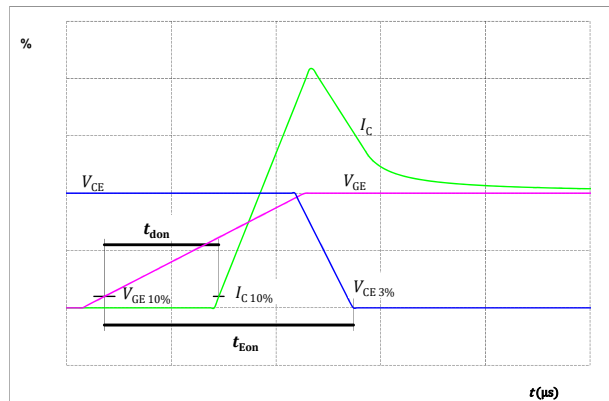

figure 50. IGBT

Turn-off Switching Waveforms & definition of t_f

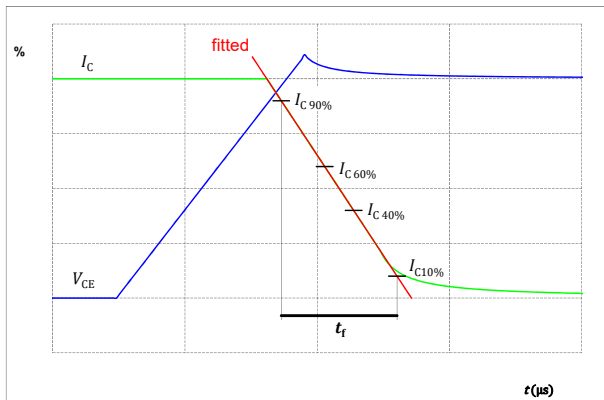
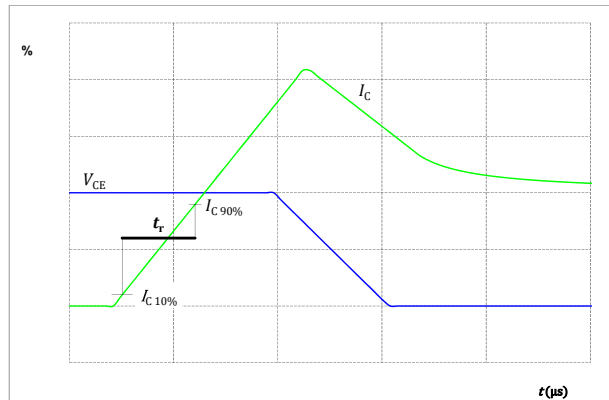

figure 51. IGBT

Turn-on Switching Waveforms & definition of t_r





Switching Definitions

figure 52. FWD

Turn-off Switching Waveforms & definition of t_{rr}

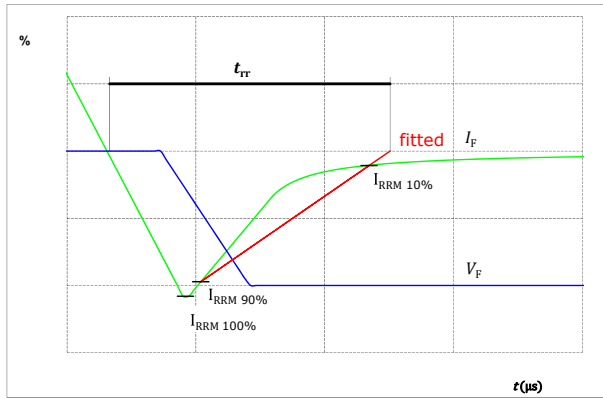
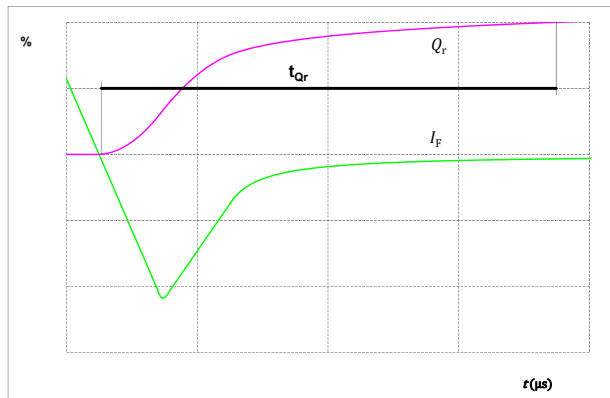

figure 53. FWD

Turn-on Switching Waveforms & definition of t_{Qr} (t_{Qr} = integrating time for Q_r)





30-FT10NIA400S701-LP59F06

datasheet

Vincotech

Ordering Code	
Version	Ordering Code
Without thermal paste	30-FT10NIA400S701-LP59F06
With thermal paste (3,4 W/mK, PSX-P7)	30-FT10NIA400S701-LP59F06-/3/

Marking							
	Text	Name NN-NNNNNNNNNNNNNNNN- TTTTTTVV		Date code WWYY	UL & VIN UL VIN	Lot LLLLL	Serial SSSS
	Datamatrix	Type&Ver TTTTTTVV	Lot number LLLLL	Serial SSSS	Date code WWYY		

Outline				
Pin table [mm]				
Pin	X	Y	Function	
1	70,9	0	DC-	
2	68,2	0	DC-	
3	65,5	0	DC-	
4	62,8	0	DC-	
5	60,1	0	DC-	
6	70,9	10,8	S12	
7	67,85	10,8	G12	
8	48,8	0	GND1	
9	46,1	0	GND1	
10	43,4	0	GND1	
11	40,7	0	GND1	
12	38	0	GND1	
13	32,9	0	GND2	
14	30,2	0	GND2	
15	27,5	0	GND2	
16	24,8	0	GND2	
17	22,1	0	GND2	
18	19,35	9,1	S11	
19	16,3	9,1	G11	
20	10,8	0	DC+	
21	8,1	0	DC+	
22	5,4	0	DC+	
23	2,7	0	DC+	
24	0	0	DC+	
25	19,75	18,7	P	
26	0	36,9	Therm1	
27	3	36,9	Therm2	
28	12,2	35,95	S13	
29	12,15	32,35	G13	
30	22,2	36,9	Ph2	
31	24,9	36,9	Ph2	
32	27,6	36,9	Ph2	
33	30,3	36,9	Ph2	
34	33	36,9	Ph2	
35	37,9	36,9	Ph1	
36	40,6	36,9	Ph1	
37	43,3	36,9	Ph1	
38	46	36,9	Ph1	
39	48,7	36,9	Ph1	
40	52,3	20,7	G14	
41	49,1	20,7	S14	
42	45,55	19,35	N	

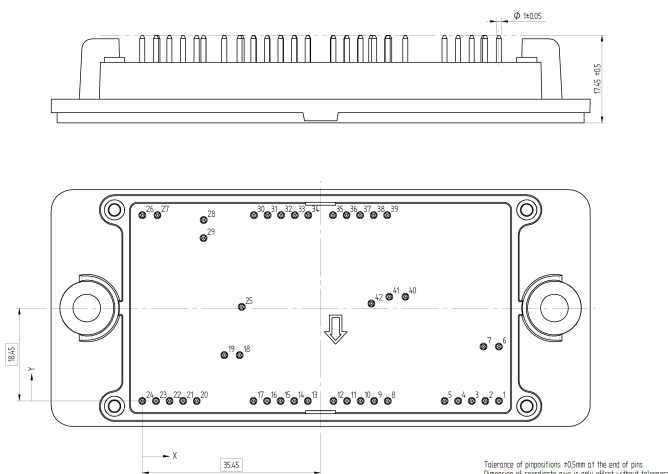

Tolerance of positions: ±0,5mm at the end of pins.
Dimension of coordinate axis is only offset without tolerance



Vincotech

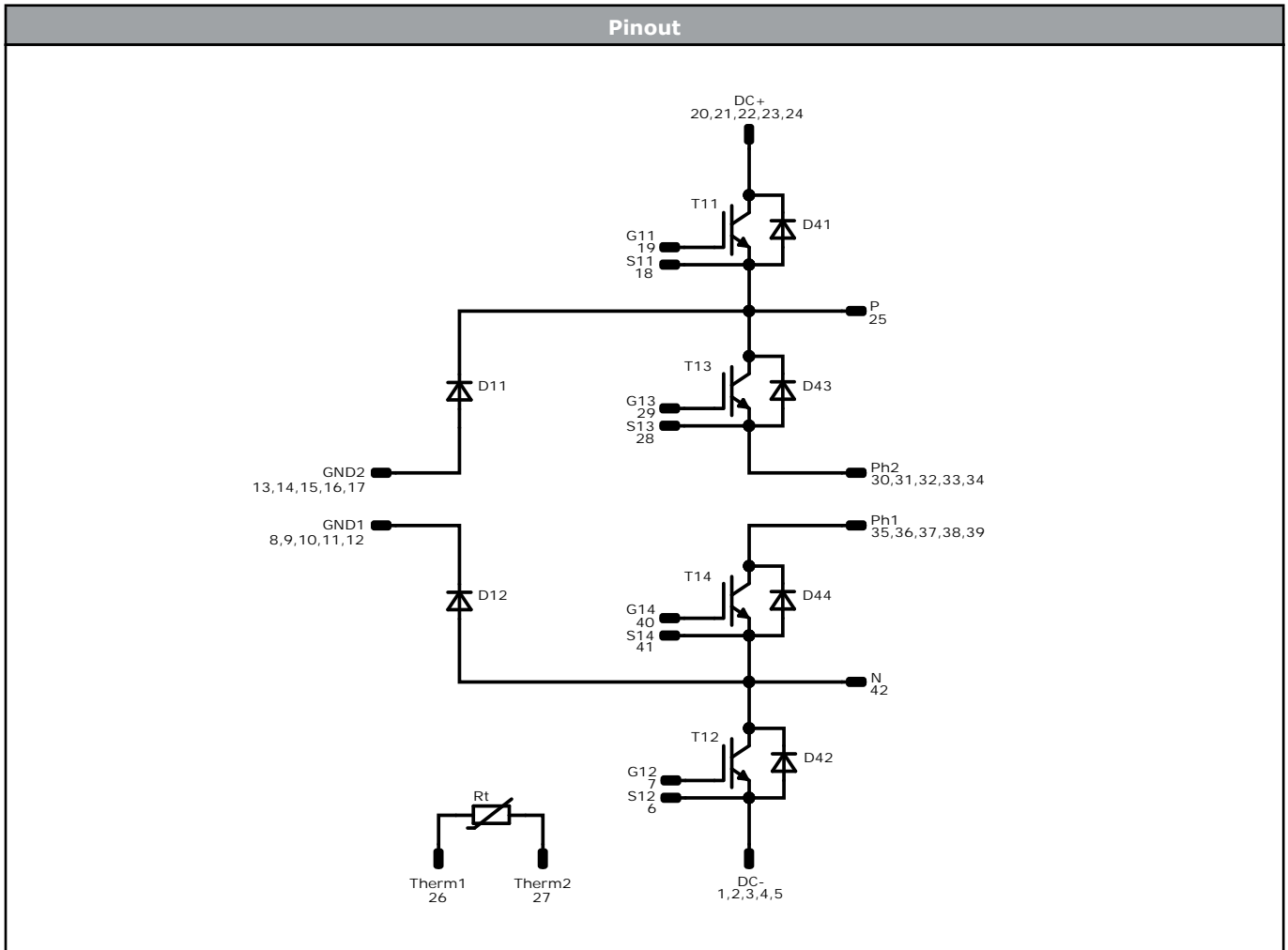

Identification					
ID	Component	Voltage	Current	Function	Comment
T11, T12	IGBT	950 V	400 A	Buck Switch	
D11, D12	FWD	1200 V	100 A	Buck Diode	
T13, T14	IGBT	950 V	400 A	Boost Switch	
D42, D41	FWD	950 V	200 A	Boost Diode	
D43, D44	FWD	950 V	200 A	Boost Sw. Inv. Diode	
Rt	NTC			Thermistor	



Packaging instruction				
Standard packaging quantity (SPQ) 36	>SPQ	Standard	<SPQ	Sample

Handling instruction
Handling instructions for <i>flow 2</i> packages see vincotech.com website.

Package data
Package data for <i>flow 2</i> packages see vincotech.com website.

Vincotech thermistor reference
See Vincotech thermistor reference table at vincotech.com website.

UL recognition and file number
This device is certified according to UL 1557 standard, UL file number E192116. For more information see vincotech.com website. 

Document No.:	Date:	Modification:	Pages
30-FT10NIA400S701-LP59F06-D4-14	31 Aug. 2023	Change Buck Diode	

DISCLAIMER

The information, specifications, procedures, methods and recommendations herein (together "information") are presented by Vincotech to reader in good faith, are believed to be accurate and reliable, but may well be incomplete and/or not applicable to all conditions or situations that may exist or occur. Vincotech reserves the right to make any changes without further notice to any products to improve reliability, function or design. No representation, guarantee or warranty is made to reader as to the accuracy, reliability or completeness of said information or that the application or use of any of the same will avoid hazards, accidents, losses, damages or injury of any kind to persons or property or that the same will not infringe third parties rights or give desired results. It is reader's sole responsibility to test and determine the suitability of the information and the product for reader's intended use.

LIFE SUPPORT POLICY

Vincotech products are not authorised for use as critical components in life support devices or systems without the express written approval of Vincotech.

As used herein:

1. Life support devices or systems are devices or systems which, (a) are intended for surgical implant into the body, or (b) support or sustain life, or (c) whose failure to perform when properly used in accordance with instructions for use provided in labelling can be reasonably expected to result in significant injury to the user.
2. A critical component is any component of a life support device or system whose failure to perform can be reasonably expected to cause the failure of the life support device or system, or to affect its safety or effectiveness.