

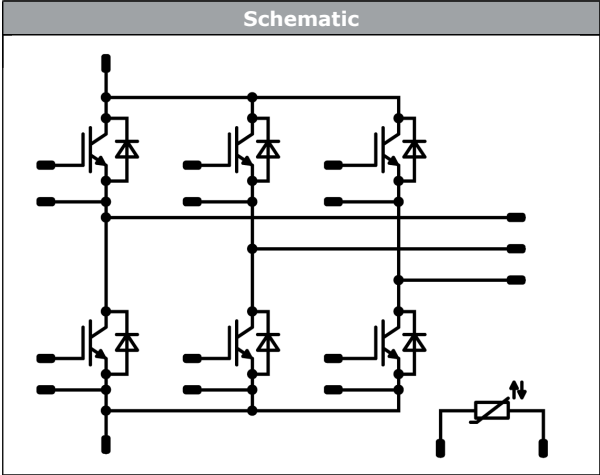

<b>VINcoPACK E3</b>		<b>1200 V / 200 A</b>	
<b>Features</b>		<b>VINco E3 17 mm housing</b>	
<ul style="list-style-type: none"><li>• IGBT Mitsubishi gen 7 technology with low VCesat and improved EMC behavior</li><li>• New SoLid Cover Technology for higher reliability</li><li>• Industry standard housing</li><li>• Press-fit pin and pre-applied phase-change Thermal Interface Material available</li></ul>			
<b>Target applications</b>		<b>Schematic</b>	
Industrial Drives			
<b>Types</b>			
<ul style="list-style-type: none"><li>• A0-VP126PA200M7-L999F70T</li></ul>			



Vincotech

## Maximum Ratings

$T_j = 25\text{ °C}$ , unless otherwise specified

Parameter	Symbol	Conditions	Value	Unit
<b>Inverter Switch</b>				
Collector-emitter voltage	$V_{CES}$		1200	V
Collector current (DC current)	$I_C$	$T_j = T_{jmax}$ $T_s = 80\text{ °C}$	173	A
Repetitive peak collector current	$I_{CRM}$	$t_p$ limited by $T_{jmax}$	400	A
Total power dissipation	$P_{tot}$	$T_j = T_{jmax}$ $T_s = 80\text{ °C}$	318	W
Gate-emitter voltage	$V_{GES}$		$\pm 20$	V
Short circuit ratings	$t_{SC}$	$V_{GE} = 15\text{ V}$ , $V_{CC} = 800\text{ V}$ $T_j = 150\text{ °C}$	9,5	$\mu\text{s}$
Maximum junction temperature	$T_{jmax}$		175	$^{\circ}\text{C}$

## Inverter Diode

Peak repetitive reverse voltage	$V_{RRM}$		1200	V
Forward current (DC current)	$I_F$	$T_j = T_{jmax}$ $T_s = 80\text{ °C}$	137	A
Repetitive peak forward current	$I_{FRM}$	$t_p$ limited by $T_{jmax}$	400	A
Total power dissipation	$P_{tot}$	$T_j = T_{jmax}$ $T_s = 80\text{ °C}$	235	W
Maximum junction temperature	$T_{jmax}$		175	$^{\circ}\text{C}$

## Module Properties

### Thermal Properties

Storage temperature	$T_{stg}$		-40...+125	$^{\circ}\text{C}$
Operation temperature under switching condition	$T_{jop}$		-40...+( $T_{jmax} - 25$ )	$^{\circ}\text{C}$

### Isolation Properties

Isolation voltage	$V_{isol}$	DC Test Voltage* $t_p = 2\text{ s}$	6000	V
Isolation voltage	$V'_{isol}$	AC Voltage $t_p = 1\text{ min}$	2500	V
Creepage distance			>12,7	mm
Clearance			9	mm
Comparative Tracking Index	CTI		$\geq 200$	

\*100 % tested in production



Vincotech

### Characteristic Values

Parameter	Symbol	Conditions					Values			Unit
		$V_{GS}$ [V]	$V_{GE}$ [V]	$V_{DS}$ [V]	$V_F$ [V]	$I_C$ [A] $I_D$ [A] $I_F$ [A]	$T_j$ [°C]	Min	Typ	

#### Inverter Switch

##### Static

Gate-emitter threshold voltage	$V_{GE(th)}$			10	0,02	25	5,4	6	6,6	V
Collector-emitter saturation voltage	$V_{CE(sat)}$		15		200	25 125 150		1,69 1,88 1,93	1,85 <sup>(1)</sup>	V
Collector-emitter cut-off current	$I_{CES}$		0	1200		25			100	μA
Gate-emitter leakage current	$I_{GES}$		20	0		25			500	nA
Internal gate resistance	$r_g$							2		Ω
Input capacitance	$C_{ies}$							37000		pF
Output capacitance	$C_{oes}$		0	10		25		1100		pF
Reverse transfer capacitance	$C_{res}$							420		pF
Gate charge	$Q_g$	$V_{CC} = 600$ V	15		200	25		1200		nC

##### Thermal

Thermal resistance junction to sink <sup>(2)</sup>	$R_{th(j-s)}$	$\lambda_{paste} = 3,4$ W/mK (PSX)						0,3		K/W
--	---------------	---------------------------------------	--	--	--	--	--	-----	--	-----

##### Dynamic

Turn-on delay time	$t_{d(on)}$					25 125 150		283,2 300 305,6		ns
Rise time	$t_r$					25 125 150		47,4 58,6 61		ns
Turn-off delay time	$t_{d(off)}$					25 125 150		232,8 263,4 273,2		ns
Fall time	$t_f$					25 125 150		76,7 94,25 96,24		ns
Turn-on energy (per pulse)	$E_{on}$	$Q_{tFWD} = 21,43$ μC $Q_{tFWD} = 31,96$ μC $Q_{tFWD} = 36,25$ μC				25 125 150		16,28 22,83 25,08		mWs
Turn-off energy (per pulse)	$E_{off}$					25 125 150		13,25 17,54 18,99		mWs



Vincotech

**A0-VP126PA200M7-L999F70T**  
datasheet

### Characteristic Values

Parameter	Symbol	Conditions					Values			Unit
		$V_{GE}$ [V] $V_{GS}$ [V]	$V_{CE}$ [V] $V_{DS}$ [V] $V_F$ [V]	$I_C$ [A] $I_D$ [A] $I_F$ [A]	$T_j$ [°C]	Min	Typ	Max		

#### Inverter Diode

##### Static

Forward voltage	$V_F$				200	25 125 150		1,86 1,99 1,98	2,1 <sup>(1)</sup>	V
Reverse leakage current	$I_R$	$V_i = 1200$ V				25			40	μA

##### Thermal

Thermal resistance junction to sink <sup>(2)</sup>	$R_{th(j-s)}$	$\lambda_{paste} = 3,4$ W/mK (PSX)						0,4		K/W
--	---------------	---------------------------------------	--	--	--	--	--	-----	--	-----

##### Dynamic

Peak recovery current	$I_{RRM}$					25 125 150		166,92 163,7 164,58		A
Reverse recovery time	$t_{rr}$					25 125 150		309,66 479,84 520,58		ns
Recovered charge	$Q_r$	$di/dt=4313$ A/μs $di/dt=4301$ A/μs $di/dt=3318$ A/μs	±15	600	200	25 125 150		21,43 31,96 36,25		μC
Reverse recovered energy	$E_{rec}$					25 125 150		8,05 12,25 13,92		mWs
Peak rate of fall of recovery current	$(di_r/dt)_{max}$					25 125 150		1395 924,44 854,82		A/μs



Vincotech

### Characteristic Values

Parameter	Symbol	Conditions					Values			Unit
		$V_{GS}$ [V]	$V_{GE}$ [V]	$V_{DS}$ [V]	$V_{CE}$ [V]	$T_j$ [°C]	Min	Typ	Max	

### Thermistor

#### Static

Rated resistance	$R$					25		5		kΩ
Deviation of $R_{100}$	$A_{R/R}$	$R_{100} = 493 \Omega$				100	-5		5	%
Power dissipation	$P$							245		mW
Power dissipation constant	$d$					25		1,4		mW/K
B-value	$B_{(25/50)}$	Tol. $\pm 2 \%$						3375		K
B-value	$B_{(25/100)}$	Tol. $\pm 2 \%$						3437		K
Vincotech Thermistor Reference									K	

<sup>(1)</sup> Value at chip level

<sup>(2)</sup> Only valid with pre-applied Vincotech thermal interface material.



## Inverter Switch Characteristics

**figure 1.** IGBT

Typical output characteristics

$$I_C = f(V_{CE})$$

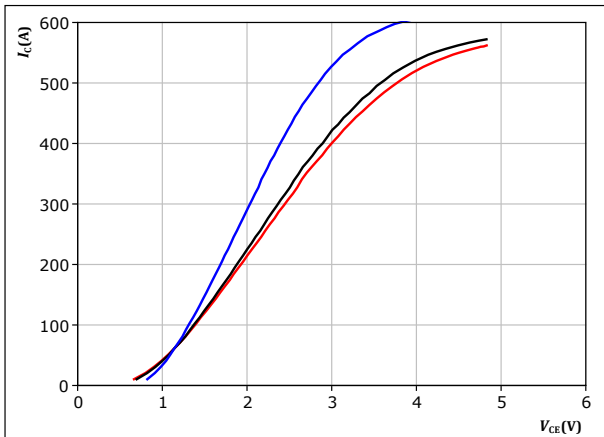

$t_p = 250 \mu s$   
 $V_{GE} = 15 V$

$T_j$ : 25 °C (blue), 125 °C (black), 150 °C (red)

**figure 2.** IGBT

Typical output characteristics

$$I_C = f(V_{CE})$$

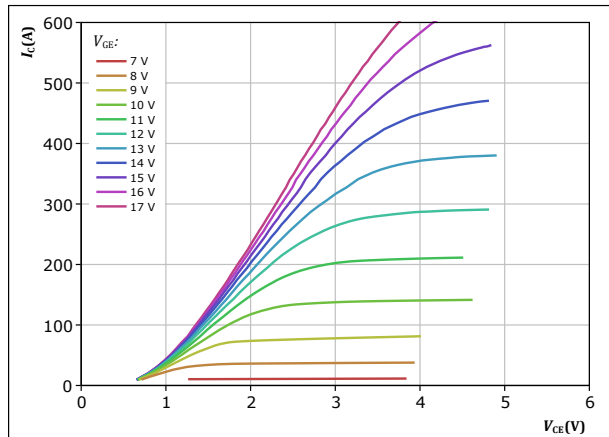

$t_p = 250 \mu s$   
 $T_j = 150 \text{ °C}$   
 $V_{GE}$  from 7 V to 17 V in steps of 1 V

**figure 3.** IGBT

Typical transfer characteristics

$$I_C = f(V_{GE})$$

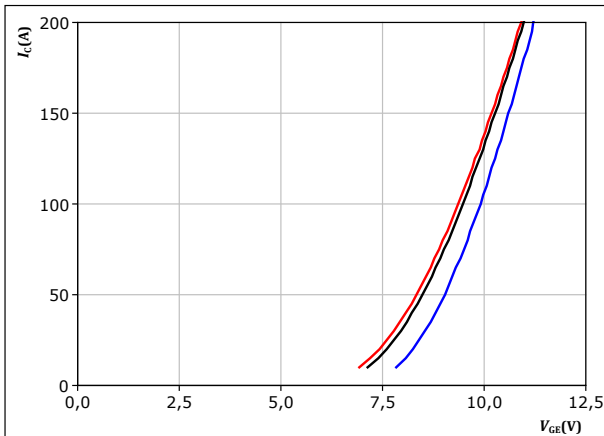

$t_p = 250 \mu s$   
 $V_{CE} = 10 V$

$T_j$ : 25 °C (blue), 125 °C (black), 150 °C (red)

**figure 4.** IGBT

Transient thermal impedance as a function of pulse width

$$Z_{th(j-s)} = f(t_p)$$

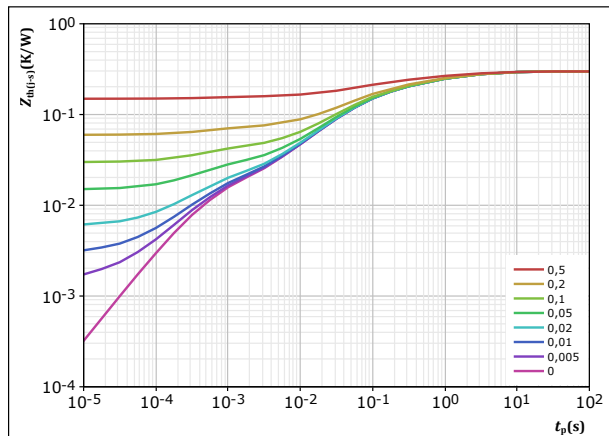

$D = t_p / T$   
 $R_{th(j-s)} = 0,298 \text{ K/W}$

IGBT thermal model values

R (K/W)	$\tau$ (s)
2,88E-02	5,48E+00
6,08E-02	1,14E+00
8,17E-02	2,27E-01
9,49E-02	4,76E-02
1,90E-02	1,06E-02
1,33E-02	4,72E-04



### Inverter Switch Characteristics

figure 5. IGBT

Safe operating area

$$I_C = f(V_{CE})$$

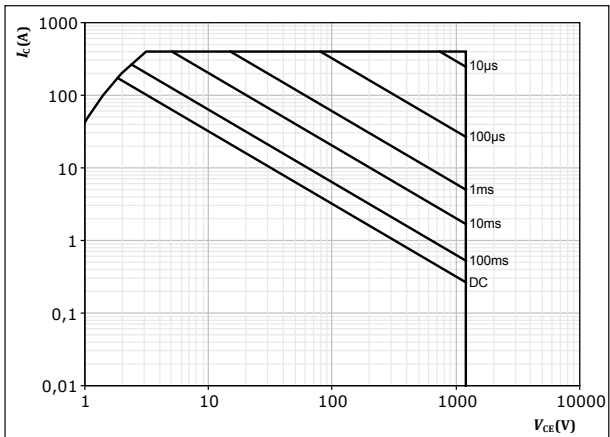

D = single pulse  
T<sub>s</sub> = 80 °C  
V<sub>GE</sub> = 15 V  
T<sub>j</sub> = T<sub>jmax</sub>



## Inverter Diode Characteristics

figure 6. FWD

Typical forward characteristics

$$I_F = f(V_F)$$

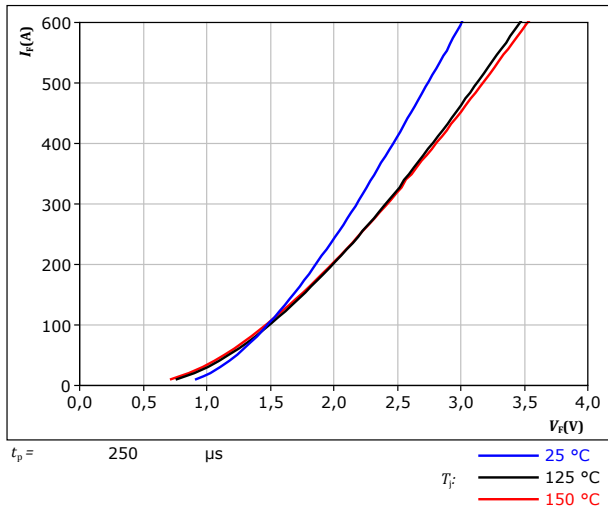
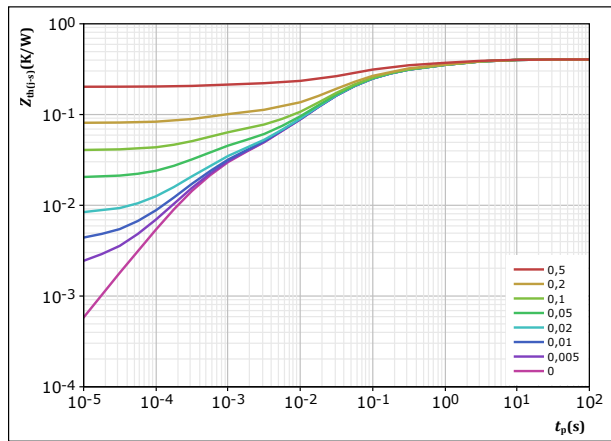

figure 7. FWD

Transient thermal impedance as a function of pulse width

$$Z_{th(j-s)} = f(t_p)$$



$D = \frac{t_p}{T}$   
 $R_{th(j-s)} = 0,405 \text{ K/W}$   
 FWD thermal model values

R (K/W)	$\tau$ (s)
2,18E-02	6,58E+00
7,39E-02	1,24E+00
1,19E-01	1,47E-01
1,51E-01	3,00E-02
1,42E-02	4,40E-03
2,45E-02	4,95E-04





## Thermistor Characteristics

**figure 8.** Thermistor

Typical NTC characteristic as function of temperature

$$R_T = f(T)$$

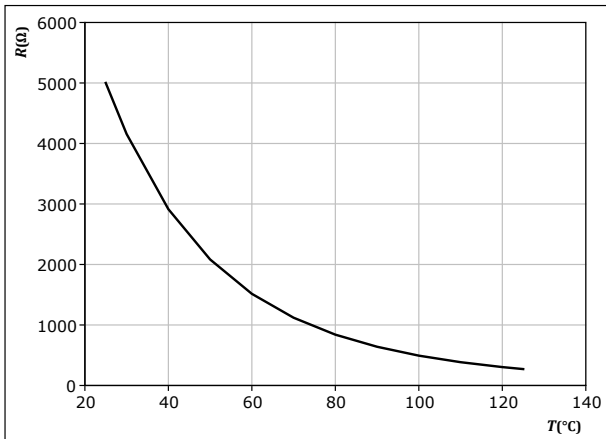



## Inverter Switching Characteristics

**figure 9.** IGBT

Typical switching energy losses as a function of collector current

$$E = f(I_c)$$

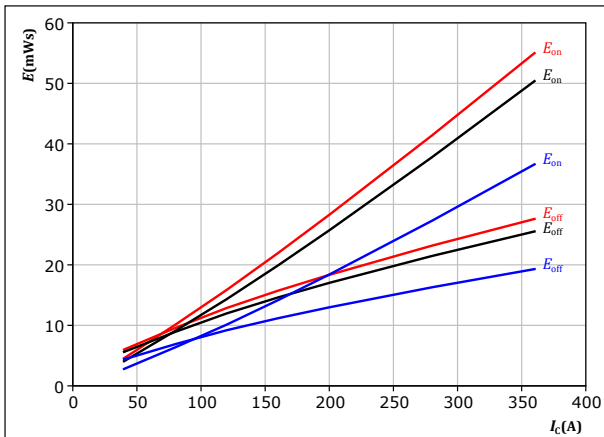

With an inductive load at

$V_{CE} = 600$  V  
 $V_{GE} = \pm 15$  V  
 $R_{gon} = 1$   $\Omega$   
 $R_{goff} = 1$   $\Omega$

$T_j$ : — 25 °C  
— 125 °C  
— 150 °C

**figure 10.** IGBT

Typical switching energy losses as a function of gate resistor

$$E = f(R_g)$$

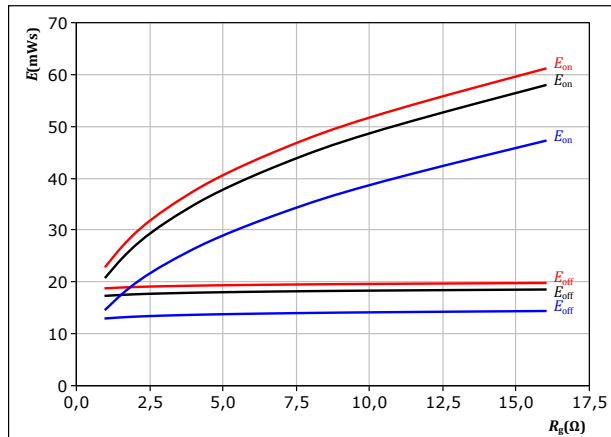

With an inductive load at

$V_{CE} = 600$  V  
 $V_{GE} = \pm 15$  V  
 $I_c = 200$  A

$T_j$ : — 25 °C  
— 125 °C  
— 150 °C

**figure 11.** FWD

Typical reverse recovered energy loss as a function of collector current

$$E_{rec} = f(I_c)$$

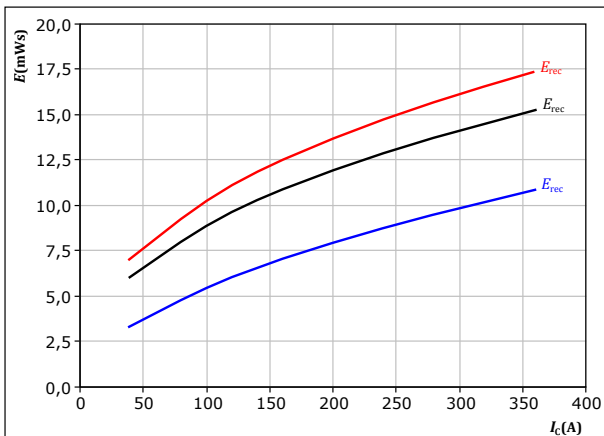

With an inductive load at

$V_{CE} = 600$  V  
 $V_{GE} = \pm 15$  V  
 $R_{gon} = 1$   $\Omega$

$T_j$ : — 25 °C  
— 125 °C  
— 150 °C

**figure 12.** FWD

Typical reverse recovered energy loss as a function of gate resistor

$$E_{rec} = f(R_g)$$

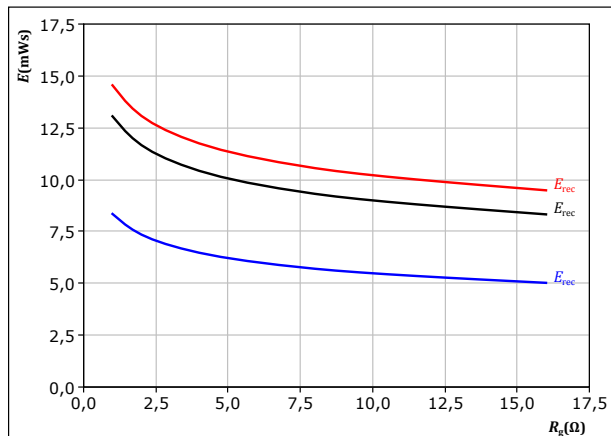

With an inductive load at

$V_{CE} = 600$  V  
 $V_{GE} = \pm 15$  V  
 $I_c = 200$  A

$T_j$ : — 25 °C  
— 125 °C  
— 150 °C



## Inverter Switching Characteristics

**figure 13.** IGBT

Typical switching times as a function of collector current  
 $t = f(I_C)$

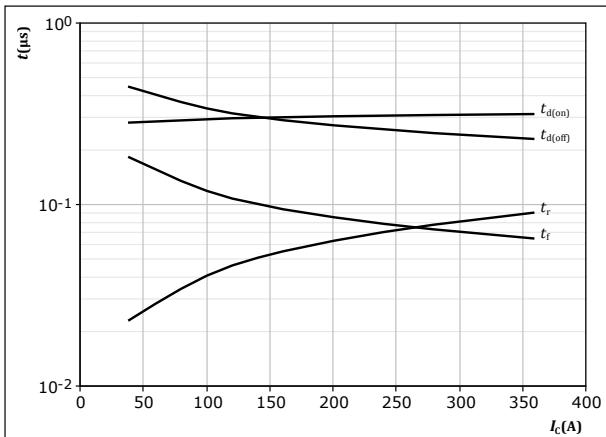

With an inductive load at  
 $T_j = 150$  °C  
 $V_{CE} = 600$  V  
 $V_{GE} = \pm 15$  V  
 $R_{g(on)} = 1$  Ω  
 $R_{g(off)} = 1$  Ω

**figure 14.** IGBT

Typical switching times as a function of gate resistor  
 $t = f(R_g)$

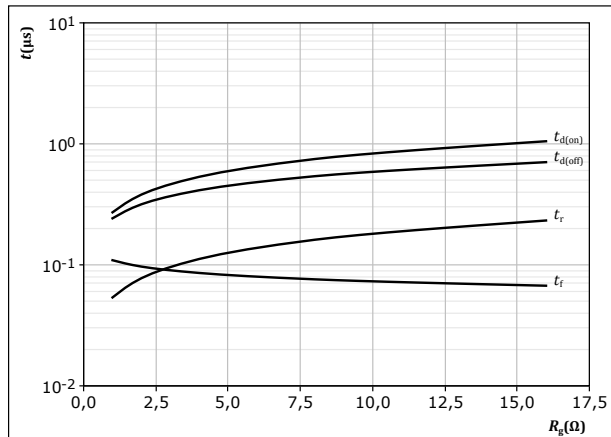

With an inductive load at  
 $T_j = 150$  °C  
 $V_{CE} = 600$  V  
 $V_{GE} = \pm 15$  V  
 $I_C = 200$  A

**figure 15.** FWD

Typical reverse recovery time as a function of collector current  
 $t_{rr} = f(I_C)$

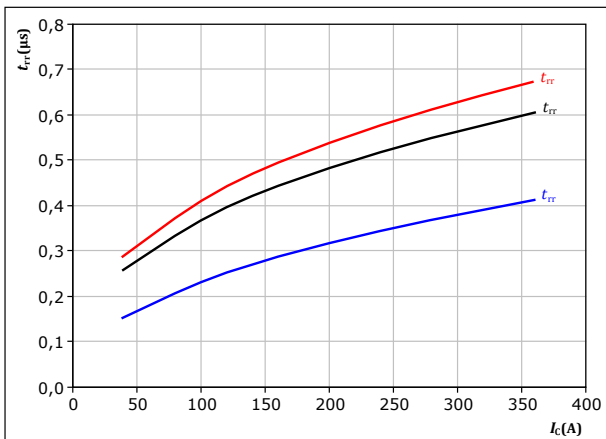

With an inductive load at  
 $V_{CE} = 600$  V  
 $V_{GE} = \pm 15$  V  
 $R_{g(on)} = 1$  Ω  
 $T_j$ : — 25 °C  
— 125 °C  
— 150 °C

**figure 16.** FWD

Typical reverse recovery time as a function of IGBT turn off gate resistor  
 $t_{rr} = f(R_{g(off)})$

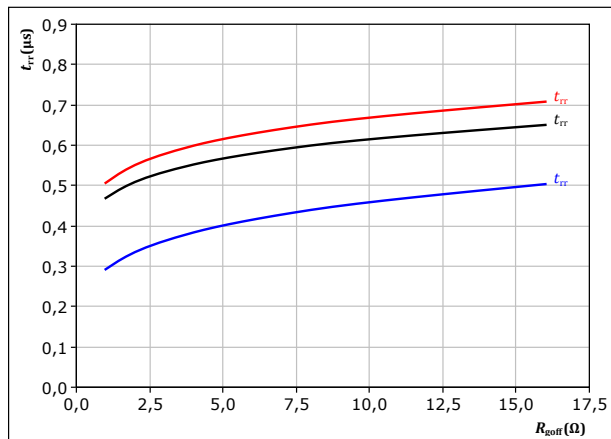

With an inductive load at  
 $V_{CE} = 600$  V  
 $V_{GE} = \pm 15$  V  
 $I_C = 200$  A  
 $T_j$ : — 25 °C  
— 125 °C  
— 150 °C



## Inverter Switching Characteristics

**figure 17.** FWD

Typical recovered charge as a function of collector current

$$Q_r = f(I_c)$$

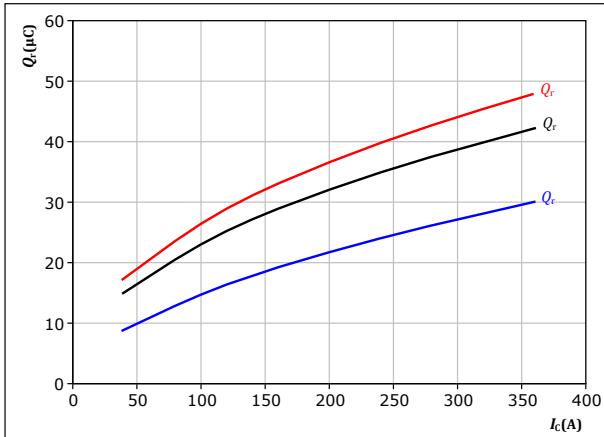

With an inductive load at

$V_{CE} = 600 \text{ V}$   
 $V_{GE} = \pm 15 \text{ V}$   
 $R_{goff} = 1 \ \Omega$

$T_j$ : — 25 °C  
— 125 °C  
— 150 °C

**figure 18.** FWD

Typical recovered charge as a function of turn off gate resistor

$$Q_r = f(R_{goff})$$

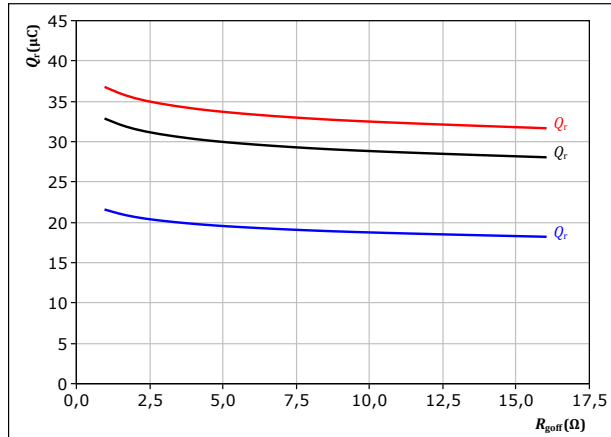

With an inductive load at

$V_{CE} = 600 \text{ V}$   
 $V_{GE} = \pm 15 \text{ V}$   
 $I_c = 200 \text{ A}$

$T_j$ : — 25 °C  
— 125 °C  
— 150 °C

**figure 19.** FWD

Typical peak reverse recovery current as a function of collector current

$$I_{RM} = f(I_c)$$

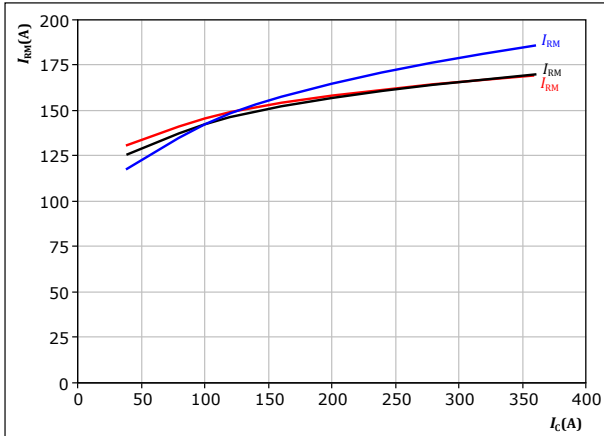

With an inductive load at

$V_{CE} = 600 \text{ V}$   
 $V_{GE} = \pm 15 \text{ V}$   
 $R_{goff} = 1 \ \Omega$

$T_j$ : — 25 °C  
— 125 °C  
— 150 °C

**figure 20.** FWD

Typical peak reverse recovery current as a function of turn off gate resistor

$$I_{RM} = f(R_{goff})$$

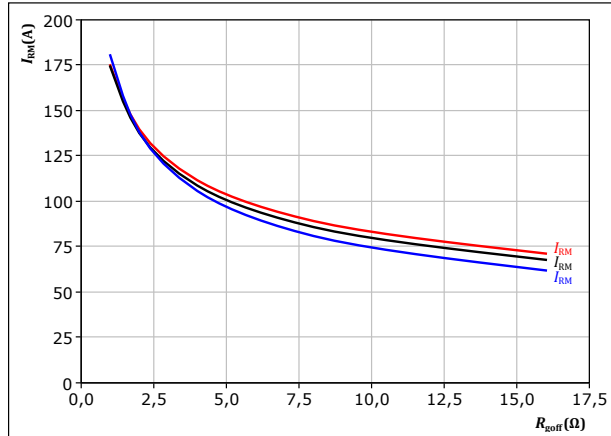

With an inductive load at

$V_{CE} = 600 \text{ V}$   
 $V_{GE} = \pm 15 \text{ V}$   
 $I_c = 200 \text{ A}$

$T_j$ : — 25 °C  
— 125 °C  
— 150 °C



## Inverter Switching Characteristics

**figure 21.** FWD

Typical rate of fall of forward and reverse recovery current as a function of collector current  
 $di_i/dt, di_r/dt = f(I_c)$

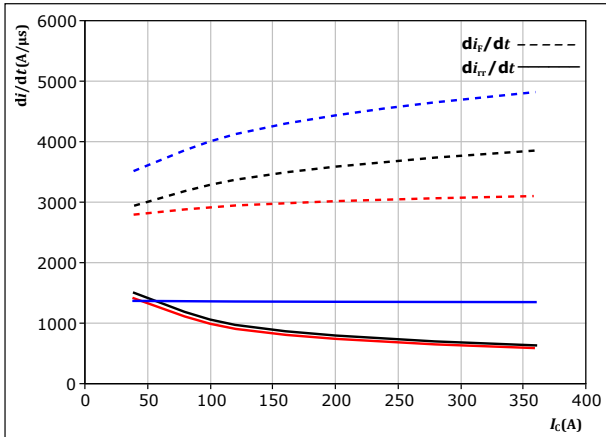

With an inductive load at

$V_{CE} =$	600	V	$T_j =$	25 °C
$V_{GE} =$	±15	V		125 °C
$R_{goff} =$	1	Ω		150 °C

**figure 22.** FWD

Typical rate of fall of forward and reverse recovery current as a function of turn off gate resistor  
 $di_i/dt, di_r/dt = f(R_{goff})$

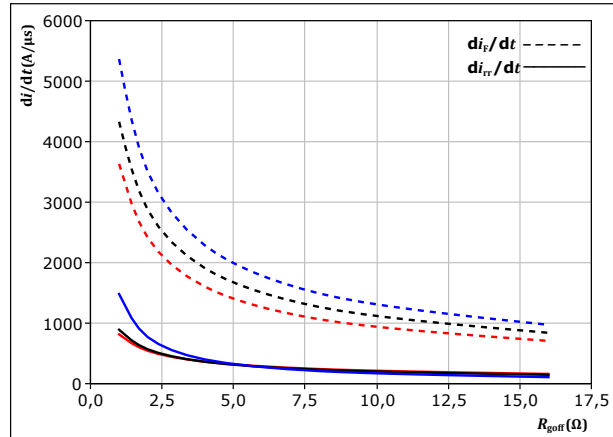

With an inductive load at

$V_{CE} =$	600	V	$T_j =$	25 °C
$V_{GE} =$	±15	V		125 °C
$I_c =$	200	A		150 °C

**figure 23.** IGBT

Reverse bias safe operating area

$I_c = f(V_{CE})$

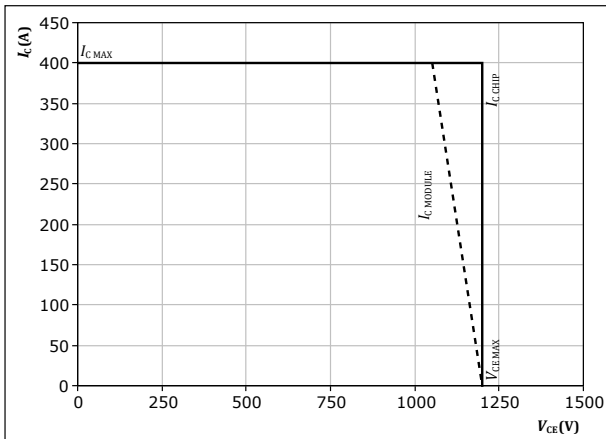

At

$T_j =$	150	°C
$R_{goff} =$	1	Ω
$R_{goff} =$	1	Ω



## Inverter Switching Definitions

**figure 24.** IGBT  
Turn-off Switching Waveforms & definition of  $t_{doff}$ ,  $t_{Eoff}$  ( $t_{Eoff}$  = integrating time for  $E_{off}$ )

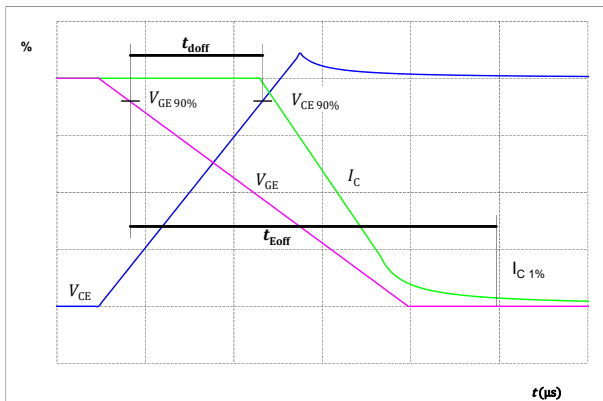

**figure 25.** IGBT  
Turn-on Switching Waveforms & definition of  $t_{don}$ ,  $t_{Eon}$  ( $t_{Eon}$  = integrating time for  $E_{on}$ )



**figure 26.** IGBT  
Turn-off Switching Waveforms & definition of  $t_f$

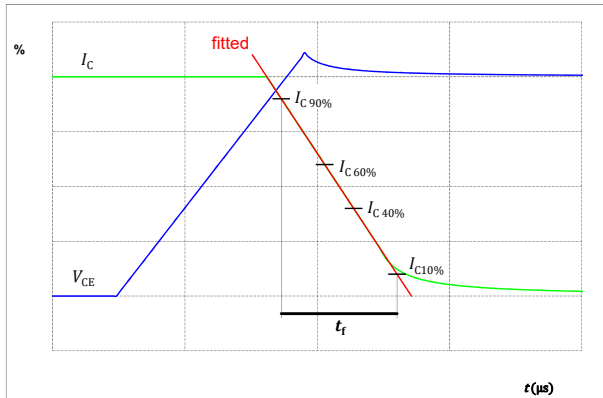

**figure 27.** IGBT  
Turn-on Switching Waveforms & definition of  $t_r$

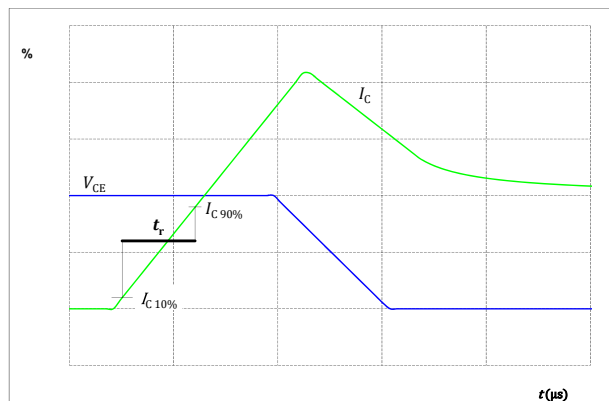



### Inverter Switching Definitions

figure 28. FWD

Turn-off Switching Waveforms & definition of  $t_{rr}$



figure 29. FWD

Turn-on Switching Waveforms & definition of  $t_{Qr}$  ( $t_{Qr}$  = integrating time for  $Q_r$ )

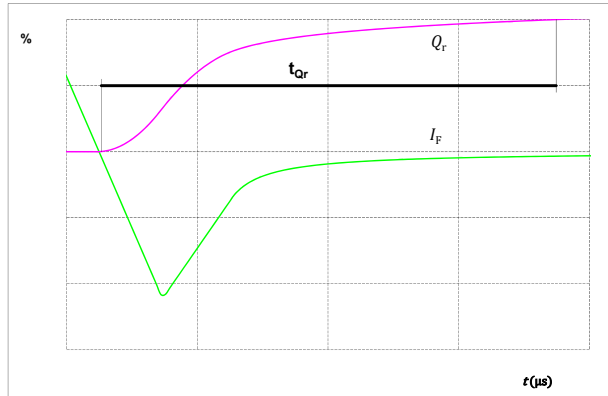



# A0-VP126PA200M7-L999F70T

datasheet

Vincotech

Ordering Code	
<b>Version</b>	<b>Ordering Code</b>
Without thermal paste	A0-VP126PA200M7-L999F70T
With thermal paste (3,4 W/mK, PSX-P7)	A0-VP126PA200M7-L999F70T-/3/

Marking						
 NN-NNNNNNNNNN-TTTTTTVV VIN WWYY LLLLL SSSS	<b>Text</b>	<b>Name</b> NN-NNNNNNNNNNNNNNNN- TTTTTVV	<b>VIN</b> VIN	<b>Date code</b> WWYY	<b>Lot</b> LLLLL	<b>Serial</b> SSSS
	<b>Datamatrix</b>	<b>Type&amp;Ver</b> TTTTTVV	<b>Lot number</b> LLLLL	<b>Serial</b> SSSS	<b>Date code</b> WWYY	

Outline				
Pin table [mm]				
Pin	X	Y	Function	
1	19,05	0	G12	
2	22,86	0	S12	
3	34,29	0	G11	
4	38,1	0	S11	
5	49,53	0	G14	
6	53,34	0	S14	
7	64,77	0	G13	
8	68,58	0	S13	
9	80,01	0	G16	
10	83,82	0	S16	
11	95,25	0	G15	
12	99,06	0	S15	
13	118,11	15,865	DC-123	
14	118,11	19,675	DC-123	
15	118,11	23,485	DC-123	
16	118,11	34,915	DC+123	
17	118,11	38,725	DC+123	
18	118,11	42,535	DC+123	
19	100,965	58,4	Therm1	
20	97,155	58,4	Therm2	
21	81,915	58,4	Ph3	
22	78,105	58,4	Ph3	
23	74,295	58,4	Ph3	
24	59,055	58,4	Ph2	
25	55,245	58,4	Ph2	
26	51,435	58,4	Ph2	
27	36,195	58,4	Ph1	
28	32,385	58,4	Ph1	
29	28,575	58,4	Ph1	
30	0	42,535	DC+123	
31	0	38,725	DC+123	
32	0	34,915	DC+123	
33	0	23,485	DC-123	
34	0	19,675	DC-123	
35	0	15,865	DC-123	

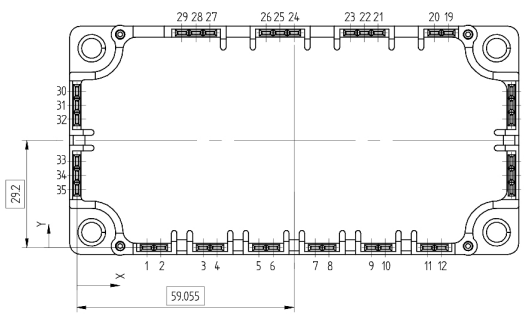



Vincotech

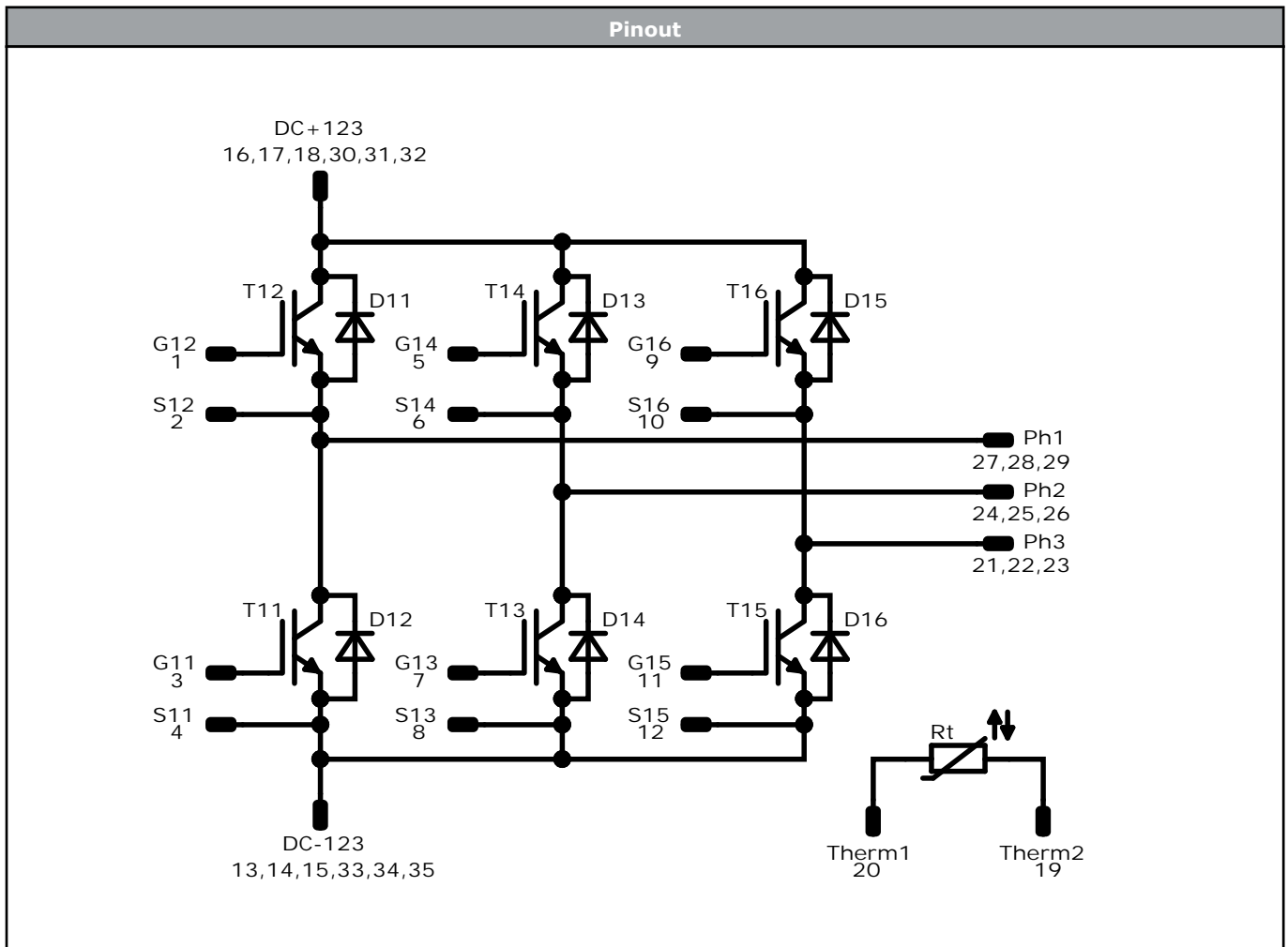

Identification					
ID	Component	Voltage	Current	Function	Comment
T11, T12, T13, T14, T15, T16	IGBT	1200 V	200 A	Inverter Switch	
D11, D12, D13, D14, D15, D16	FWD	1200 V	200 A	Inverter Diode	
Rt	NTC			Thermistor	



Packaging instruction				
Standard packaging quantity (SPQ) 24	>SPQ	Standard	<SPQ	Sample

Handling instruction
Handling instructions for VINco E3 packages see vincotech.com website.

Package data
Package data for VINco E3 packages see vincotech.com website.

Vincotech thermistor reference
See Vincotech thermistor reference table at vincotech.com website.

UL recognition and file number
This device is certified according to UL 1557 standard, UL file number E192116. For more information see vincotech.com website. 

Document No.:	Date:	Modification:	Pages
A0-VP126PA200M7-L999F70T-D2-14	26 Sep. 2021	Thermal characteristics are updated Separated datasheet for press-fit version New datasheet format, module is unchanged	

**DISCLAIMER**

The information, specifications, procedures, methods and recommendations herein (together "information") are presented by Vincotech to reader in good faith, are believed to be accurate and reliable, but may well be incomplete and/or not applicable to all conditions or situations that may exist or occur. Vincotech reserves the right to make any changes without further notice to any products to improve reliability, function or design. No representation, guarantee or warranty is made to reader as to the accuracy, reliability or completeness of said information or that the application or use of any of the same will avoid hazards, accidents, losses, damages or injury of any kind to persons or property or that the same will not infringe third parties rights or give desired results. It is reader's sole responsibility to test and determine the suitability of the information and the product for reader's intended use.

**LIFE SUPPORT POLICY**

Vincotech products are not authorised for use as critical components in life support devices or systems without the express written approval of Vincotech.

As used herein:

1. Life support devices or systems are devices or systems which, (a) are intended for surgical implant into the body, or (b) support or sustain life, or (c) whose failure to perform when properly used in accordance with instructions for use provided in labelling can be reasonably expected to result in significant injury to the user.
2. A critical component is any component of a life support device or system whose failure to perform can be reasonably expected to cause the failure of the life support device or system, or to affect its safety or effectiveness.