

PAGE 1/2	ISSUE 15-04-22A	SERIES TERMINATION	PART NUMBER R404505000
----------	---------------------------	------------------------------	-------------------------------

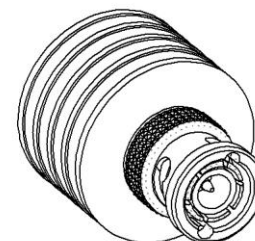

All dimensions are in mm. Tolerances according ISO 2768 c-K

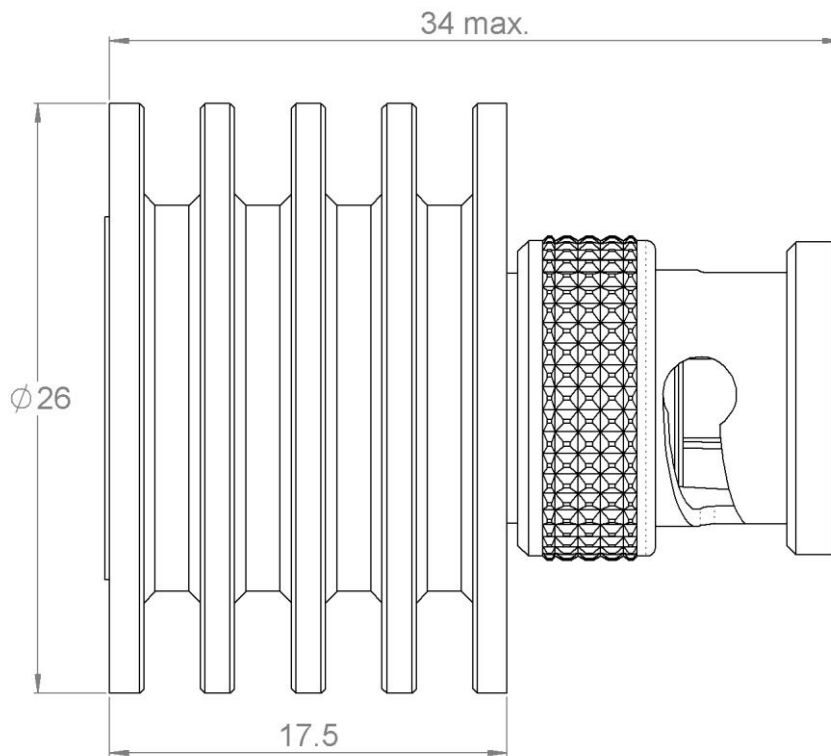
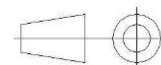

COMPONENTS	MATERIALS	PLATING (μm)
Body	BRASS	NICKEL 5
Center contact	BRASS	GOLD 2.5 OVER NICKEL 1
Outer contact		
Insulator	PTFE	
Gasket	SILICONE RUBBER	
Substrate	ALUMINA	
Resistor	THICK FILM	
Others parts	ALUMINIUM	BLACK ANODIZATION

PAGE 2/2	ISSUE 15-04-22A	SERIES TERMINATION	PART NUMBER R404505000
----------	---------------------------	------------------------------	-------------------------------

ELECTRICAL CHARACTERISTICS

Frequency (GHz)	DC - 2
V.S.W.R (≤)	1.10

Operating Frequency Range	DC - 2	GHz
Impedance	50	Ω
DC Resistance	50	Ω ± 5%
Peak power at 25°C (1μs, 1%)	1500	W
Average power at 25°C	6	W (Free Air Cooled)
		W (Conduction Cooled)

MECHANICAL CHARACTERISTICS

Connectors	BNC	Male	MIL C 39012
Weight (±15%)	25,3300 g		

ENVIRONMENTAL CHARACTERISTICS

Operating temperature range	-55/+125	°C
Storage temperature range	-55/+125	°C

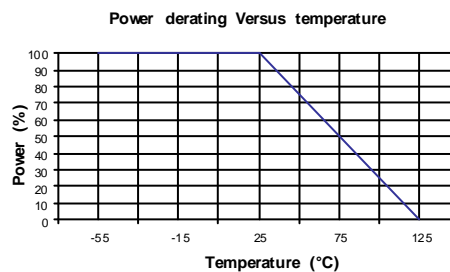

SPECIFICATION

OTHER CHARACTERISTICS